

CCAMP Working Group  
Internet-Draft  
Intended status: Standards Track  
Expires: October 6, 2013

D. Ceccarelli, Ed.  
D. Caviglia  
Ericsson  
F. Zhang  
D. Li  
Huawei Technologies  
S. Belotti  
P. Grandi  
Alcatel-Lucent  
R. Rao  
K. Pithewan  
Infinera Corporation  
J. Drake  
Juniper  
April 4, 2013

Traffic Engineering Extensions to OSPF for Generalized MPLS (GMPLS)  
Control of Evolving G.709 OTN Networks  
draft-ietf-ccamp-gmpls-ospf-g709v3-06

#### Abstract

ITU-T Recommendation G.709 [[G.709-2012](#)] has introduced new fixed and flexible Optical Data Unit (ODU) containers, enabling optimized support for an increasingly abundant service mix.

This document describes Open Shortest Path First - Traffic Engineering (OSPF-TE) routing protocol extensions to support Generalized MPLS (GMPLS) control of all currently defined ODU containers, in support of both sub-lambda and lambda level routing granularity.

#### Status of this Memo

This Internet-Draft is submitted in full conformance with the provisions of [BCP 78](#) and [BCP 79](#).

Internet-Drafts are working documents of the Internet Engineering Task Force (IETF). Note that other groups may also distribute working documents as Internet-Drafts. The list of current Internet-Drafts is at <http://datatracker.ietf.org/drafts/current/>.

Internet-Drafts are draft documents valid for a maximum of six months and may be updated, replaced, or obsoleted by other documents at any time. It is inappropriate to use Internet-Drafts as reference material or to cite them other than as "work in progress."

Internet-Draft

OSPF-TE extensions for OTN support

April 2013

This Internet-Draft will expire on October 6, 2013.

#### Copyright Notice

Copyright (c) 2013 IETF Trust and the persons identified as the document authors. All rights reserved.

This document is subject to [BCP 78](#) and the IETF Trust's Legal Provisions Relating to IETF Documents (<http://trustee.ietf.org/license-info>) in effect on the date of publication of this document. Please review these documents carefully, as they describe your rights and restrictions with respect to this document. Code Components extracted from this document must include Simplified BSD License text as described in Section 4.e of the Trust Legal Provisions and are provided without warranty as described in the Simplified BSD License.

Internet-Draft

OSPF-TE extensions for OTN support

April 2013

## Table of Contents

<a href="#">1.</a>	Introduction . . . . .	<a href="#">4</a>
<a href="#">1.1.</a>	Terminology . . . . .	<a href="#">4</a>
<a href="#">2.</a>	OSPF-TE Extensions . . . . .	<a href="#">4</a>
<a href="#">3.</a>	TE-Link Representation . . . . .	<a href="#">6</a>
<a href="#">4.</a>	ISCD format extensions . . . . .	<a href="#">7</a>
<a href="#">4.1.</a>	Switch Capability Specific Information . . . . .	<a href="#">8</a>
4.1.1.	Switch Capability Specific Information for fixed containers . . . . .	<a href="#">9</a>
4.1.2.	Switch Capability Specific Information for variable containers . . . . .	<a href="#">9</a>
4.1.3.	Switch Capability Specific Information - Field values and explanation . . . . .	<a href="#">10</a>
<a href="#">5.</a>	Examples . . . . .	<a href="#">13</a>
<a href="#">5.1.</a>	MAX LSP Bandwidth fields in the ISCD . . . . .	<a href="#">13</a>
<a href="#">5.2.</a>	Example of T,S and TSG utilization . . . . .	<a href="#">15</a>
<a href="#">5.2.1.</a>	Example of different TSGs . . . . .	<a href="#">16</a>
<a href="#">5.3.</a>	Example of ODUFlex advertisement . . . . .	<a href="#">18</a>
<a href="#">5.4.</a>	Example of single stage muxing . . . . .	<a href="#">21</a>
<a href="#">5.5.</a>	Example of multi stage muxing - Unbundled link . . . . .	<a href="#">23</a>
<a href="#">5.6.</a>	Example of multi stage muxing - Bundled links . . . . .	<a href="#">25</a>
5.7.	Example of component links with non homogeneous hierarchies . . . . .	<a href="#">26</a>
<a href="#">6.</a>	Compatibility . . . . .	<a href="#">28</a>
<a href="#">7.</a>	Security Considerations . . . . .	<a href="#">29</a>
<a href="#">8.</a>	IANA Considerations . . . . .	<a href="#">29</a>
<a href="#">9.</a>	Contributors . . . . .	<a href="#">30</a>
<a href="#">10.</a>	Acknowledgements . . . . .	<a href="#">32</a>
<a href="#">11.</a>	References . . . . .	<a href="#">32</a>
<a href="#">11.1.</a>	Normative References . . . . .	<a href="#">32</a>
<a href="#">11.2.</a>	Informative References . . . . .	<a href="#">32</a>
	Authors' Addresses . . . . .	<a href="#">33</a>

## 1. Introduction

G.709 Optical Transport Network (OTN) [[G.709-2012](#)] includes new fixed and flexible ODU containers, two types of Tributary Slots (i.e. 1.25Gbps and 2.5Gbps), and supports various multiplexing relationships (e.g., ODU<sub>j</sub> multiplexed into ODU<sub>k</sub> (j<k)), two different tributary slots for ODU<sub>k</sub> (K=1, 2, 3) and ODUflex service type, which is being standardized in ITU-T. In order to present this information in the routing process, this document provides OTN technology specific encoding for OSPF-TE.

For a short overview of OTN evolution and implications of OTN requirements on GMPLS routing please refer to [[OTN-FWK](#)]. The information model and an evaluation against the current solution are provided in [[OTN-INFO](#)].

The routing information for Optical Channel Layer (OCh) (i.e. wavelength) is out of the scope of this document. Please refer to [[RFC6163](#)] and [[RFC6566](#)] for further information.

### 1.1. Terminology

The key words "MUST", "MUST NOT", "REQUIRED", "SHALL", "SHALL NOT", "SHOULD", "SHOULD NOT", "RECOMMENDED", "MAY", and "OPTIONAL" in this document are to be interpreted as described in [[RFC2119](#)].

## 2. OSPF-TE Extensions

In terms of GMPLS based OTN networks, each OTUk can be viewed as a component link, and each component link can carry one or more types of ODUj (j<k).

Each TE Link State Advertisement (LSA) can carry a top-level link Type Length Value (TLV) with several nested sub-TLVs to describe different attributes of a TE link. Two top-level TLVs are defined in [RFC3630]. (1) The Router Address TLV (referred to as the Node TLV) and (2) the TE link TLV. One or more sub-TLVs can be nested into the two top-level TLVs. The sub-TLV set for the two top-level TLVs are also defined in [RFC3630] and [RFC4203].

As discussed in [OTN-FWK] and [OTN-INFO], OSPF-TE must be extended so to be able to advertise the termination and switching capabilities related to each different ODUj and ODUk/OTUk (Optical Transport Unit) and the advertisement of related multiplexing capabilities. This leads to the need to define a new Switching Capability value and associated new Switching Capability for the Interface Switching Capability Descriptor (ISCD).

In the following we will use ODUj to indicate a service type that is multiplexed into a higher order ODU, ODUk to indicate a higher order ODU including an ODUj and ODUk/OTUk to indicate the layer mapped into the OTUk. Moreover ODUj(S) and ODUk(S) are used to indicate ODUj and ODUk supporting switching capability only, and the ODUj->ODUk format is used to indicate the ODUj into ODUk multiplexing capability.

This notation can be repeated as needed depending on the number of multiplexing levels. In the following the term "multiplexing tree" is used to identify a multiplexing hierarchy where the root is always a server ODUk/OTUk and any other supported multiplexed container is represented with increasing granularity until reaching the leaf of the tree. The tree can be structured with more than one branch if the server ODUk/OTUk supports more than one hierarchy.

If for example a multiplexing hierarchy like the following one is considered:

```
ODU2 ODU0      ODUflex ODU0
  \ /          \ /
```

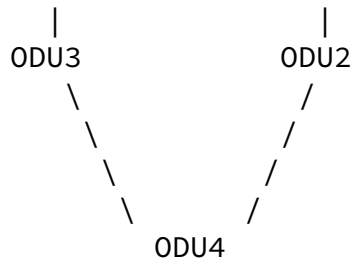

The ODU4 is the root of the muxing tree, ODU3 and ODU2 are containers directly multiplexed into the server and then ODU2, ODU0 are the leaves of the ODU3 branch, while ODUflex and ODU0 are the leaves of the ODU2 one. This means that on this traffic card it is possible to have the following multiplexing capabilities:

```

ODU2->ODU3->ODU4
ODU0->ODU3->ODU4
ODUflex->ODU2->ODU4
ODU0->ODU2->ODU4
  
```

### 3. TE-Link Representation

G.709 ODUk/OTUk Links are represented as TE-Links in GMPLS Traffic Engineering Topology for supporting ODUj layer switching. These TE-Links can be modeled in multiple ways.

OTUk physical Link(s) can be modeled as a TE-Link(s). The TE-Link is referred to as OTUk-TE-Link. The OTUk-TE-Link advertises ODUj switching capacity. The advertised capacity could include ODUk switching capacity. Figure-1 below provides an illustration of one hop ODUk TE-links.

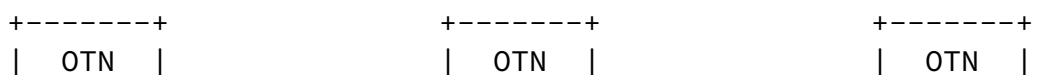

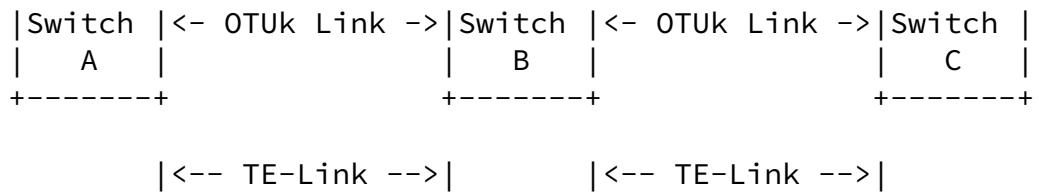

Figure 1: ODUk TE-Links

It is possible to create TE-Links that span more than one hop by creating FA between non-adjacent nodes. Such TE-Links are also termed ODUk-TE-Links. As in the one hop case, these types of ODUk-TE-Links also advertise ODUj switching capacity. The advertised capacity could include ODUk switching capacity.

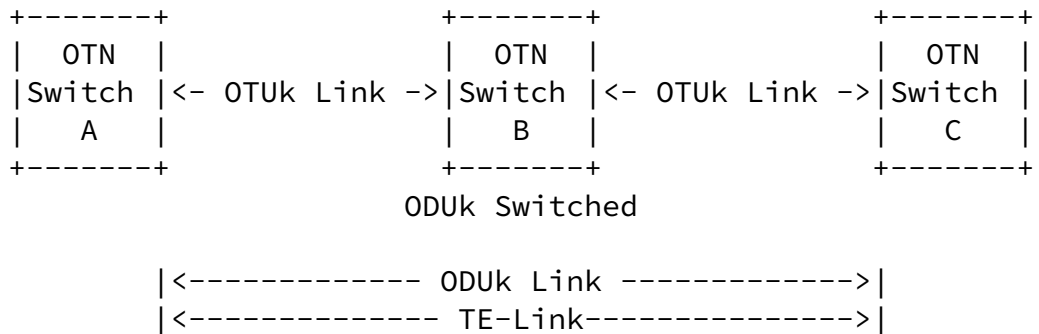

Figure 2: Multiple hop TE-Link

#### 4. ISCD format extensions

The ISCD describes the switching capability of an interface [RFC4202]. This document defines a new Switching Capability value for OTN [G.709-2012] as follows:

Value	Type
-------	------

-----  
110 (TBA by IANA)

-----  
OTN-TDM capable (OTN-TDM)

When supporting the extensions defined in this document, the Switching Capability and Encoding values MUST be used as follows:

- Switching Capability = OTN-TDM
- Encoding Type = G.709 ODUk (Digital Path) [as defined in [RFC4328](#)]

Both for fixed and flexible ODUs the same switching type and encoding values MUST be used. When Switching Capability and Encoding fields are set to values as stated above, the Interface Switching Capability Descriptor MUST be interpreted as defined in [[RFC4203](#)].

#### Maximum LSP Bandwidth

The MAX LSP bandwidth field MUST be used according to [[RFC4203](#)]: i.e.  $0 \leq \text{Max LSP Bandwidth} \leq \text{ODUk/OTUk}$  and intermediate values are those on the branch of OTN switching hierarchy supported by the interface. E.g. in the OTU4 link it could be possible to have ODU4 as MAX LSP Bandwidth for some priorities, ODU3 for others, ODU2 for some others etc. The bandwidth unit MUST be in bytes per second and the encoding MUST be in Institute of Electrical and Electronic Engineers (IEEE) floating point format. The discrete values for various ODUs is shown in the table below.



ODU Type	ODU nominal bit rate	Value in Byte/Sec
ODU0	1 244 160 kbits/s	0x4D1450C0
ODU1	239/238 x 2 488 320 kbit/s	0x4D94F048
ODU2	239/237 x 9 953 280 kbit/s	0x4E959129
ODU3	239/236 x 39 813 120 kbit/s	0X4F963367
ODU4	239/227 x 99 532 800 kbit/s	0x504331E3
ODU2e	239/237 x 10 312 500 kbit/s	0x4E9AF70A
ODUflex for CBR Client signals	239/238 x client signal bit rate	MAX LSP BANDWIDTH
ODUflex for GFP-F Mapped client signal	Configured bit rate	MAX LSP BANDWIDTH
ODU flex resizable	Configured bit rate	MAX LSP BANDWIDTH

A single ISCD MAY be used for the advertisement of unbundled or bundled links supporting homogeneous multiplexing hierarchies and the same Tributary Slot Granularity (TSG). A different ISCD MUST be used for each different muxing hierarchy (muxing tree in the following examples) and different TSG supported within the TE Link.

Component links with different hierarchies or TSG MUST NOT be bundled.

#### 4.1. Switch Capability Specific Information

The technology specific part of the OTN ISCD may include a variable number of sub-TLVs called Bandwidth sub-TLVs. Each sub-TLV is encoded with the TLV header as defined in [\[RFC3630\] section 2.3.2](#). The muxing hierarchy tree MUST be encoded as an order independent list. Two types of Bandwidth TLV are defined (TBA by IANA):

- Type 1 - Unreserved Bandwidth for fixed containers
- Type 2 - Unreserved/MAX LSP Bandwidth for flexible containers

The SCSI MUST include one Type 1 sub-TLV for any fixed container and one Type 2 sub-TLV for any variable container.

With respect to ODUflex, three different signal types are allowed: 20 - ODUflex Constant Bit Rate (CBR), 21 - ODUflex Generic Framing

Procedure-Frame mapped (GFP-F) resizable and 22 - ODUflex (GFP-F) non resizable. Each MUST always be advertised in separate Type 2 TLVs as each uses different adaptation functions [G.805]. In the case that both GFP-F resizable and non resizable (i.e. 21 and 22) are supported, only Signal Type 21 SHALL be advertised as this type also implies support for type 22 adaptation.

4.1.1. Switch Capability Specific Information for fixed containers

The format of the Bandwidth TLV for fixed containers is depicted in the following figure:

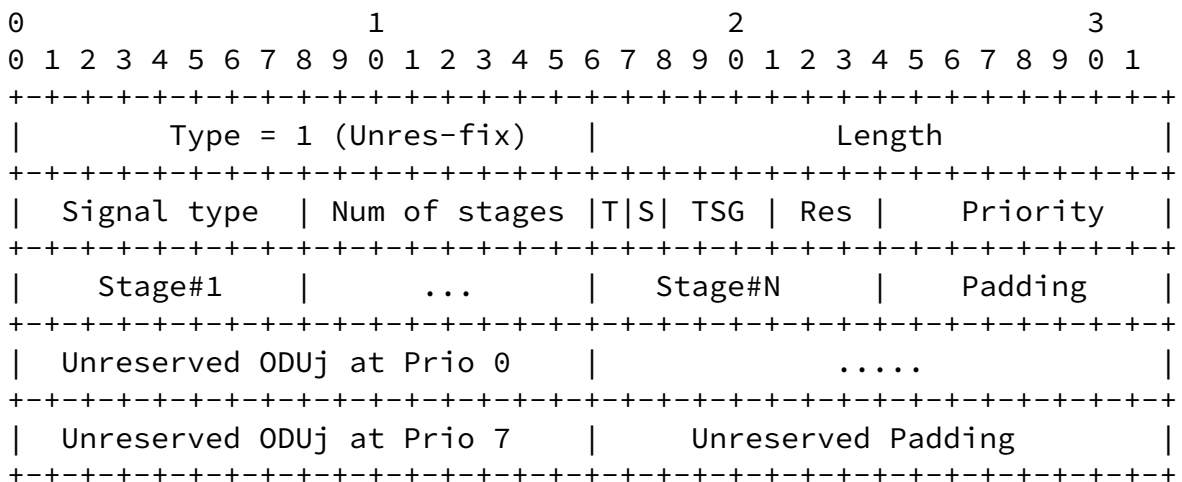

Figure 3: Bandwidth TLV - Type 1 -

The values of the fields shown in figure 4 are explained in [section 4.1.3](#).

4.1.2. Switch Capability Specific Information for variable containers

The format of the Bandwidth TLV for variable containers is depicted in the following figure:

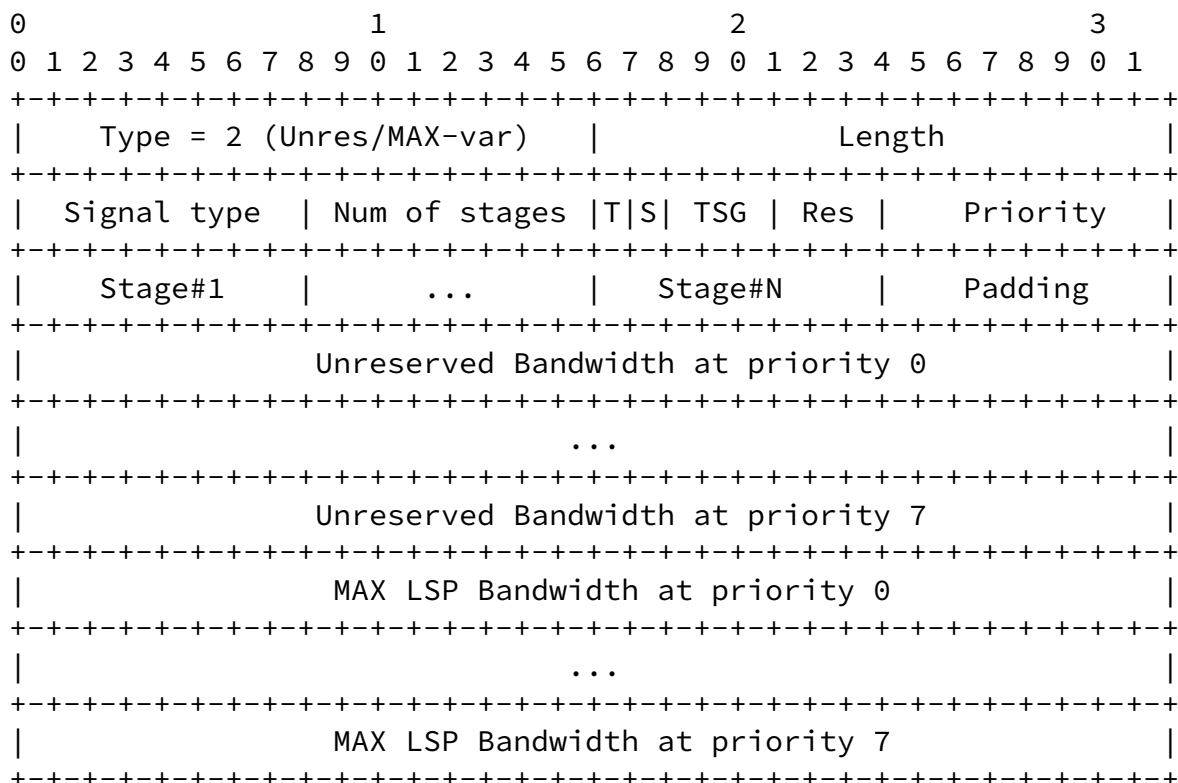

Figure 4: Bandwidth TLV - Type 2 -

The values of the fields shown in figure 4 are explained in [section 4.1.3](#).

**4.1.3. Switch Capability Specific Information - Field values and explanation**

The fields in the Bandwidth TLV MUST be filled as follows:

- Signal Type (8 bits): Indicates the ODU type being advertised. Values are defined in [\[OTN-SIG\]](#).
- Number of stages (8 bits): This field indicates the number of multiplexing stages used to transport the indicated signal type. It MUST be set to the number of stages represented in the TLV.

- Flags (8 bits):

- T Flag (bit 17): Indicates whether the advertised bandwidth can be terminated. When the signal type can be terminated T MUST be set, while when the signal type cannot be terminated T MUST be cleared.

- S Flag (bit 18): Indicates whether the advertised bandwidth can be switched. When the signal type can be switched S MUST be set, while when the signal type cannot be switched S MUST be cleared.

The value 0 in both T and S bits MUST NOT be used.

- TSG: Tributary Slot Granularity (3 bits): Used for the advertisement of the supported Tributary Slot granularity. The following values MUST be used:

- 0 - Ignored
- 1 - 1.25 Gbps/2.5Gbps
- 2 - 2.5 Gbps only
- 3 - 1.25 Gbps only
- 4-7 - Reserved

A value of 1 MUST be used on interfaces which are configured to support the fall back procedures defined in [G.798-a2]. A value of 2 MUST be used on interfaces that only support 2.5 Gbps time slots, such as [RFC4328](#) interfaces. A value of 3 MUST be used on interfaces that are configured to only support 1.25 Gbps time slots. A value of 0 MUST be used for non multiplexed signal types (i.e. a non OTN client).

- Res (3 bits): reserved bits. MUST be set to 0 and ignored on receipt.

- Priority (8 bits): a bitmap used to indicate which priorities are being advertised. The bitmap is in ascending order, with the leftmost bit representing priority level 0 (i.e. the highest) and the rightmost bit representing priority level 7 (i.e. the lowest). A bit MUST be set (1) corresponding to each priority represented in the TLV, and MUST NOT be set (0) when the corresponding priority is not represented. At least one priority level MUST be advertised that, unless overridden by local policy, SHALL be at priority level 0.

- Stage (8 bits): Each Stage field indicates a signal type in the multiplexing hierarchy used to transport the signal indicated in the Signal Type field. The number of Stage fields included in a TLV MUST equal the value of the Number of Stages field. The Stage fields MUST be ordered to match the data plane in ascending order (from the lowest order ODU to the highest order ODU). The values

of the Stage field are the same as those defined for the Signal Type field. When the Number of stage field carries a 0, then the Stage and Padding fields MUST be omitted.

- Padding (variable): The Padding field is used to ensure the 32 bit alignment of stage fields. The length of the Padding field is always a multiple of 8 bits (1 byte). Its length can be calculated, in bytes, as:  $4 - (\text{"value of Number of Stages field"} \% 4)$ . The Padding field MUST be set to a zero (0) value on transmission and MUST be ignored on receipt.

- Unreserved ODUj (16 bits): This field indicates the Unreserved Bandwidth at a particular priority level. This field MUST be set to the number of ODUs at the indicated the Signal Type for a particular priority level. One field MUST be present for each bit set in the Priority field, and is ordered to match the Priority field. Fields MUST NOT be present for priority levels that are not indicated in the Priority field.

- Unreserved Padding (16 bits): The Padding field is used to ensure the 32 bit alignment of Unreserved ODUj fields. When present the Unreserved Padding field is 16 bits (2 byte) long. When the number of priorities is odd, the Unreserved Padding field MUST be included. When the number of priorities is even, the Unreserved Padding MUST be omitted.

- Unreserved Bandwidth (32 bits): This field indicates the Unreserved Bandwidth at a particular priority level. This field MUST be set to the bandwidth, in bits/s in IEEE floating point format, available at the indicated Signal Type for a particular priority level. One field MUST be present for each bit set in the Priority field, and is ordered to match the Priority field. Fields MUST not be present for priority levels that are not indicated in the Priority field. This field is REQUIRED for Type 2 (variable container) TLVs, and MUST NOT be used for Type 1 TLVs.

- Maximum LSP Bandwidth (32 bit): This field indicates the maximum bandwidth that can be allocated for a single LSP at a particular priority level. This field MUST be set to the maximum bandwidth, in bits/s in IEEE floating point format, available to a single LSP at the indicated Signal Type for a particular priority level. One field MUST be present for each bit set in the Priority field, and is ordered to match the Priority field. Fields MUST NOT be present for priority levels that are not indicated in the Priority field. The advertisement of the MAX LSP bandwidth MUST take into account HO OPUk bit rate tolerance and be calculated according to the following formula:

$$\text{Max LSP BW} = (\# \text{ available TS}) * (\text{ODTUK.ts nominal bit rate}) * (1 - \text{HO OPUk bit rate tolerance})$$

## 5. Examples

The examples in the following pages are not normative and are not intended to imply or mandate any specific implementation.

### 5.1. MAX LSP Bandwidth fields in the ISCD

This example shows how the MAX LSP Bandwidth fields of the ISCD are filled accordingly to the evolving of the TE-link bandwidth occupancy. In the example an OTU4 link is considered, with supported priorities 0,2,4,7 and muxing hierarchy ODU1->ODU2->ODU3->ODU4.

At time T0, with the link completely free, the advertisement would be:

```

0                               1                               2                               3
0 1 2 3 4 5 6 7 8 9 0 1 2 3 4 5 6 7 8 9 0 1 2 3 4 5 6 7 8 9 0 1
+---+---+---+---+---+---+---+---+---+---+---+---+---+---+---+---+
| SwCap=OTN_TDM | Encoding = 12 |   Reserved (all zeros)   |
+---+---+---+---+---+---+---+---+---+---+---+---+---+---+---+---+
|           Max LSP Bandwidth at priority 0 = 100Gbps     |
+---+---+---+---+---+---+---+---+---+---+---+---+---+---+---+---+
|           Max LSP Bandwidth at priority 1 = 0           |
+---+---+---+---+---+---+---+---+---+---+---+---+---+---+---+---+
|           Max LSP Bandwidth at priority 2 = 100Gbps     |
+---+---+---+---+---+---+---+---+---+---+---+---+---+---+---+---+
|           Max LSP Bandwidth at priority 3 = 0           |
+---+---+---+---+---+---+---+---+---+---+---+---+---+---+---+---+
|           Max LSP Bandwidth at priority 4 = 100Gbps     |
+---+---+---+---+---+---+---+---+---+---+---+---+---+---+---+---+
|           Max LSP Bandwidth at priority 5 = 0           |
+---+---+---+---+---+---+---+---+---+---+---+---+---+---+---+---+
|           Max LSP Bandwidth at priority 6 = 0           |
+---+---+---+---+---+---+---+---+---+---+---+---+---+---+---+---+
|           Max LSP Bandwidth at priority 7 = 100Gbps     |
+---+---+---+---+---+---+---+---+---+---+---+---+---+---+---+---+
|           Switch Capability Specific Information         |
|           (variable length)                             |
+---+---+---+---+---+---+---+---+---+---+---+---+---+---+---+---+

```

Figure 5: Example 1 - MAX LSP Bandwidth fields in the ISCD @T0

At time T1 an ODU3 at priority 2 is set-up, so for priority 0 the MAX LSP Bandwidth is still equal to the ODU4 bandwidth, while for priorities from 2 to 7 (excluding the non supported ones) the MAX LSP Bandwidth is equal to ODU3, as no more ODU4s are available and the next supported ODUj in the hierarchy is ODU3. The advertisement is updated as follows:

```

0                               1                               2                               3
0 1 2 3 4 5 6 7 8 9 0 1 2 3 4 5 6 7 8 9 0 1 2 3 4 5 6 7 8 9 0 1
+---+---+---+---+---+---+---+---+---+---+---+---+---+---+---+---+

```

```

| SwCap=OTN_TDM | Encoding = 12 | Reserved (all zeros) |
+-----+-----+-----+-----+-----+-----+-----+-----+-----+-----+-----+-----+
| Max LSP Bandwidth at priority 0 = 100Gbps |
+-----+-----+-----+-----+-----+-----+-----+-----+-----+-----+-----+-----+
| Max LSP Bandwidth at priority 1 = 0 |
+-----+-----+-----+-----+-----+-----+-----+-----+-----+-----+-----+-----+
| Max LSP Bandwidth at priority 2 = 40Gbps |
+-----+-----+-----+-----+-----+-----+-----+-----+-----+-----+-----+-----+
| Max LSP Bandwidth at priority 3 = 0 |
+-----+-----+-----+-----+-----+-----+-----+-----+-----+-----+-----+-----+
| Max LSP Bandwidth at priority 4 = 40Gbps |
+-----+-----+-----+-----+-----+-----+-----+-----+-----+-----+-----+-----+
| Max LSP Bandwidth at priority 5 = 0 |
+-----+-----+-----+-----+-----+-----+-----+-----+-----+-----+-----+-----+
| Max LSP Bandwidth at priority 6 = 0 |
+-----+-----+-----+-----+-----+-----+-----+-----+-----+-----+-----+-----+
| Max LSP Bandwidth at priority 7 = 40Gbps |
+-----+-----+-----+-----+-----+-----+-----+-----+-----+-----+-----+-----+
| Switch Capability Specific Information |
| (variable length) |
+-----+-----+-----+-----+-----+-----+-----+-----+-----+-----+-----+-----+

```

Figure 6: Example 1 - MAX LSP Bandwidth fields in the ISCD @T1

At time T2 an ODU2 at priority 4 is set-up. The first ODU3 is no longer available since T1 as it was kept by the ODU3 LSP, while the second is no more available and just 3 ODU2 are left in it. ODU2 is now the MAX LSP bandwidth for priorities higher than 4. The advertisement is updated as follows:

```

0 1 2 3 4 5 6 7 8 9 0 1 2 3 4 5 6 7 8 9 0 1 2 3 4 5 6 7 8 9 0 1
+-----+-----+-----+-----+-----+-----+-----+-----+-----+-----+-----+-----+
| SwCap=OTN_TDM | Encoding = 12 | Reserved (all zeros) |

```



```

+-----+-----+-----+-----+-----+-----+-----+-----+-----+-----+
|           Max LSP Bandwidth at priority 0 = 100Gbps           |
+-----+-----+-----+-----+-----+-----+-----+-----+-----+-----+
|           Max LSP Bandwidth at priority 1 = 0                 |
+-----+-----+-----+-----+-----+-----+-----+-----+-----+-----+
|           Max LSP Bandwidth at priority 2 = 40Gbps           |
+-----+-----+-----+-----+-----+-----+-----+-----+-----+-----+
|           Max LSP Bandwidth at priority 3 = 0                 |
+-----+-----+-----+-----+-----+-----+-----+-----+-----+-----+
|           Max LSP Bandwidth at priority 4 = 10Gbps           |
+-----+-----+-----+-----+-----+-----+-----+-----+-----+-----+
|           Max LSP Bandwidth at priority 5 = 0                 |
+-----+-----+-----+-----+-----+-----+-----+-----+-----+-----+
|           Max LSP Bandwidth at priority 6 = 0                 |
+-----+-----+-----+-----+-----+-----+-----+-----+-----+-----+
|           Max LSP Bandwidth at priority 7 = 10Gbps           |
+-----+-----+-----+-----+-----+-----+-----+-----+-----+-----+
|           Switch Capability Specific Information                 |
|           (variable length)                                   |
+-----+-----+-----+-----+-----+-----+-----+-----+-----+-----+

```

Figure 7: Example 1 - MAX LSP Bandwidth fields in the ISCD @T2

[5.2.](#) Example of T,S and TSG utilization

In this example an interface with Tributary Slot Type 1.25 Gbps and fallback procedure enabled is considered (TSG=1). It supports the simple ODU1->ODU2->ODU3 hierarchy and priorities 0 and 3. Suppose that in this interface the ODU3 signal type can be both switched or terminated, the ODU2 can only be terminated and the ODU1 switched only. Please note that since the ODU1 is not being advertised to support ODU0 the value of is "ignored" (TSG=0). For the advertisement of the capabilities of such interface a single ISCD is used and its format is as follows:

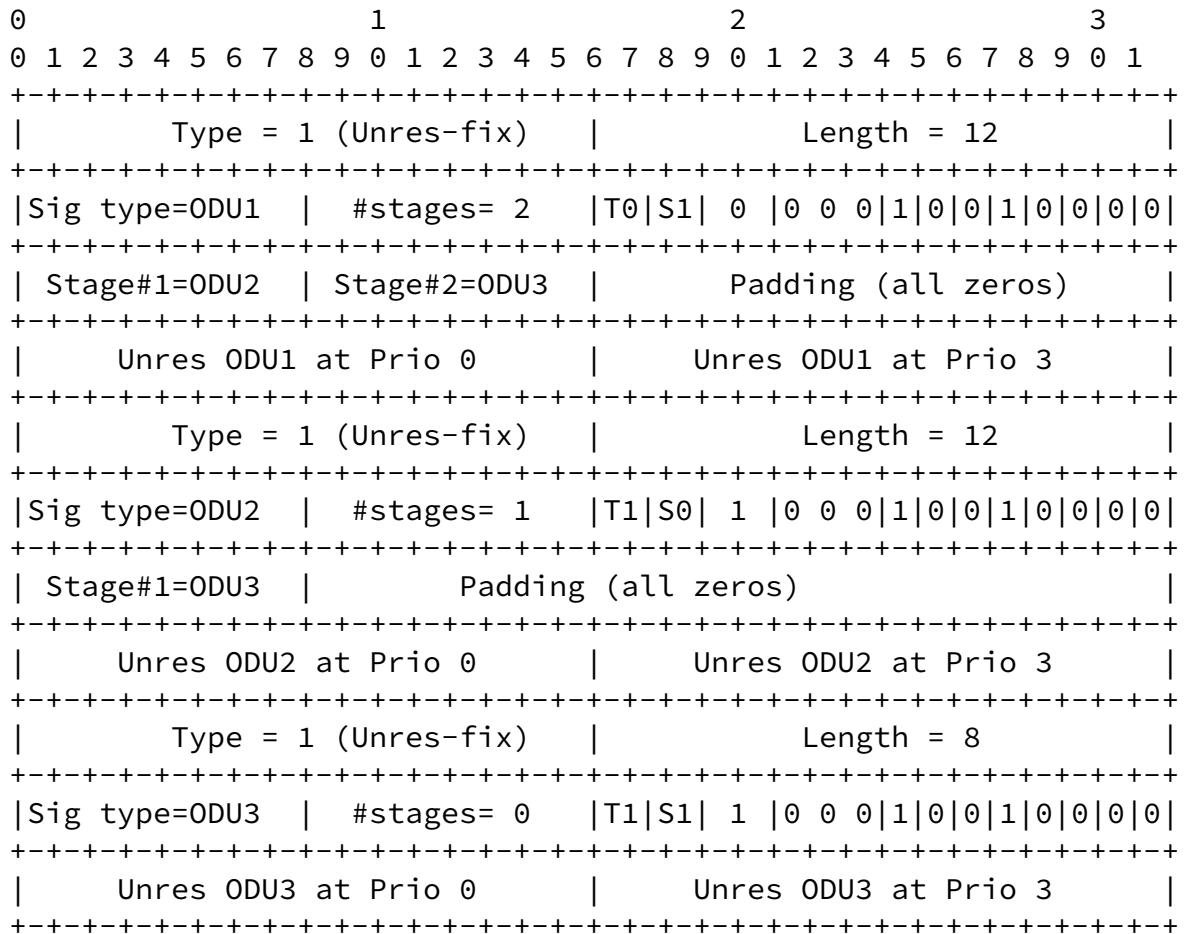
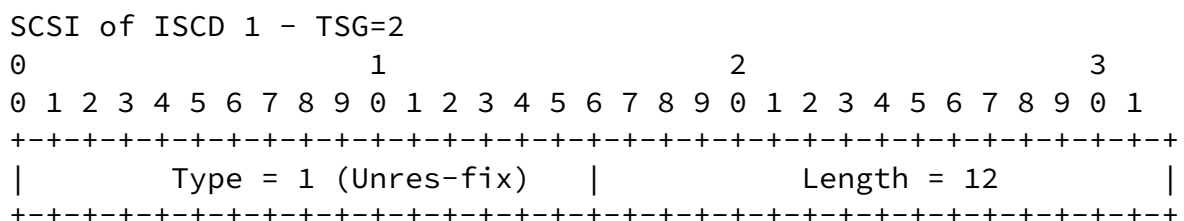

Figure 8: Example 2 - TSG, T and S utilization

5.2.1. Example of different TSGs

In this example two interfaces with homogeneous hierarchies but different Tributary Slot Types are considered. The first one supports a [RFC4328](#) interface (TSG=2) while the second one a G.709-2012 interface with fallback procedure disabled (TSG=3). Both of them support ODU1->ODU2->ODU3 hierarchy and priorities 0 and 3. T and S bits values are not relevant to this example. For the advertisement of the capabilities of such interfaces two different ISCDs are used and the format of their SCSIs is as follows:



|Sig type=ODU1 | #stages= 2 |T0|S1| 0 |0 0 0|1|0|0|1|0|0|0|0|

```

+-----+-----+-----+-----+-----+-----+-----+-----+-----+-----+
| Stage#1=ODU2 | Stage#2=ODU3 |          Padding (all zeros)          |
+-----+-----+-----+-----+-----+-----+-----+-----+-----+-----+
|   Unres ODU1 at Prio 0   |   Unres ODU1 at Prio 3   |
+-----+-----+-----+-----+-----+-----+-----+-----+-----+-----+
|          Type = 1 (Unres-fix)          |          Length = 12          |
+-----+-----+-----+-----+-----+-----+-----+-----+-----+-----+
|Sig type=ODU2 | #stages= 1 |T1|S0| 1 |0 0 0|1|0|0|1|0|0|0|0|
+-----+-----+-----+-----+-----+-----+-----+-----+-----+-----+
| Stage#1=ODU3 |          Padding (all zeros)          |
+-----+-----+-----+-----+-----+-----+-----+-----+-----+-----+
|   Unres ODU2 at Prio 0   |   Unres ODU2 at Prio 3   |
+-----+-----+-----+-----+-----+-----+-----+-----+-----+-----+
|          Type = 1 (Unres-fix)          |          Length = 8          |
+-----+-----+-----+-----+-----+-----+-----+-----+-----+-----+
|Sig type=ODU3 | #stages= 0 |T1|S1| 2 |0 0 0|1|0|0|1|0|0|0|0|
+-----+-----+-----+-----+-----+-----+-----+-----+-----+-----+
|   Unres ODU3 at Prio 0   |   Unres ODU3 at Prio 3   |
+-----+-----+-----+-----+-----+-----+-----+-----+-----+-----+

```

SCSI of ISCD 2 - TSG=3

```

0          1          2          3
0 1 2 3 4 5 6 7 8 9 0 1 2 3 4 5 6 7 8 9 0 1 2 3 4 5 6 7 8 9 0 1
+-----+-----+-----+-----+-----+-----+-----+-----+-----+-----+
|          Type = 1 (Unres-fix)          |          Length = 12          |
+-----+-----+-----+-----+-----+-----+-----+-----+-----+-----+
|Sig type=ODU1 | #stages= 2 |T0|S1| 0 |0 0 0|1|0|0|1|0|0|0|0|
+-----+-----+-----+-----+-----+-----+-----+-----+-----+-----+
| Stage#1=ODU2 | Stage#2=ODU3 |          Padding (all zeros)          |
+-----+-----+-----+-----+-----+-----+-----+-----+-----+-----+
|   Unres ODU1 at Prio 0   |   Unres ODU1 at Prio 3   |
+-----+-----+-----+-----+-----+-----+-----+-----+-----+-----+
|          Type = 1 (Unres-fix)          |          Length = 12          |
+-----+-----+-----+-----+-----+-----+-----+-----+-----+-----+
|Sig type=ODU2 | #stages= 1 |T1|S0| 1 |0 0 0|1|0|0|1|0|0|0|0|
+-----+-----+-----+-----+-----+-----+-----+-----+-----+-----+
| Stage#1=ODU3 |          Padding (all zeros)          |
+-----+-----+-----+-----+-----+-----+-----+-----+-----+-----+
|   Unres ODU2 at Prio 0   |   Unres ODU2 at Prio 3   |
+-----+-----+-----+-----+-----+-----+-----+-----+-----+-----+

```

```

|          Type = 1 (Unres-fix)          |          Length = 8          |
+---+---+---+---+---+---+---+---+---+---+---+---+---+---+---+---+---+---+---+---+---+---+
|Sig type=ODU3 | #stages= 0 |T1|S1| 3 |0 0 0|1|0|0|1|0|0|0|0|
+---+---+---+---+---+---+---+---+---+---+---+---+---+---+---+---+---+---+---+---+---+---+
|          Unres ODU3 at Prio 0          |          Unres ODU3 at Prio 3          |
+---+---+---+---+---+---+---+---+---+---+---+---+---+---+---+---+---+---+---+---+---+---+

```

Figure 9: Example 2.1 - Different TSGs utilization

A particular case in which hierarchies with the same muxing tree but with different exported TSG MUST be considered as non homogenous hierarchies is the case in which an H-LPS and the client LSP are terminated on the same egress node. What can happen is that a loose Explicit Route Object (ERO) is used at the hop where the signaled LSP is nested into the Hierarchical-LSP (H-LSP) (penultimate hop of the LSP).

In the following figure, node C receives from A a loose ERO towards node E and must choose between the ODU2 H-LSP on if1 or the one on if2. In case the H-LSP on if1 exports a TS=1.25Gbps and if2 a TS=2.5Gbps and the service LSP being signaled needs a 1.25Gbps tributary slot, only the H-LSP on if1 can be used to reach node E. For further details please see [section 4.1](#) of the [OTN-INFO].

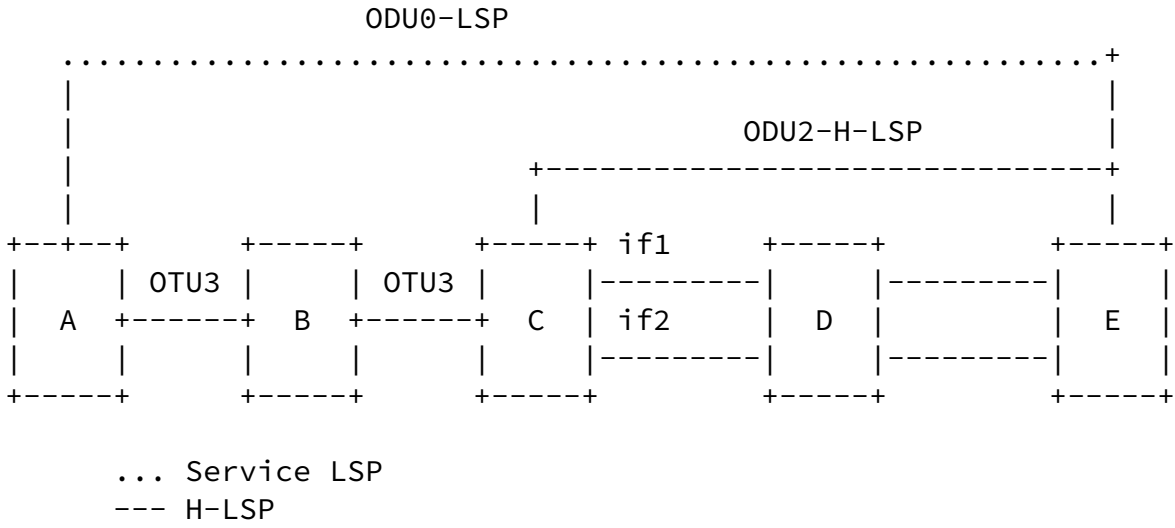

Figure 10: Example - Service LSP and H-LSP terminating on the same node

### 5.3. Example of ODUFlex advertisement

In this example the advertisement of an ODUFlex->ODU3 hierarchy is shown. In case of ODUFlex advertisement the MAX LSP bandwidth needs to be advertised and in some cases also information about the Unreserved bandwidth could be useful. The amount of Unreserved bandwidth does not give a clear indication of how many ODUFlex LSP can be set up either at the MAX LSP Bandwidth or at different rates, as it gives no information about the spatial allocation of the free TSs.

Ceccarelli, et al.

Expires October 6, 2013

[Page 18]

---

Internet-Draft

OSPF-TE extensions for OTN support

April 2013

An indication of the amount of Unreserved bandwidth could be useful during the path computation process, as shown in the following example. Supposing there are two TE-links (A and B) with MAX LSP Bandwidth equal to 10 Gbps each. In case 50Gbps of Unreserved Bandwidth are available on Link A, 10Gbps on Link B and 3 ODUFlex LSPs of 10 GBps each, have to be restored, for sure only one can be restored along Link B and it is probable (but not sure) that two of them can be restored along Link A. T, S and TSG fields are not relevant to this example.

In the case of ODUFlex advertisement the Type 2 Bandwidth TLV is used.

```

0                               1                               2                               3
0 1 2 3 4 5 6 7 8 9 0 1 2 3 4 5 6 7 8 9 0 1 2 3 4 5 6 7 8 9 0 1
+---+---+---+---+---+---+---+---+---+---+---+---+---+---+---+---+
|   Type = 2 (Unres/MAX-var)   |           Length = 72           |
+---+---+---+---+---+---+---+---+---+---+---+---+---+---+---+---+
|S. type=ODUflex| #stages= 1 |T|S| TSG |0 0 0| Priority(8) |
+---+---+---+---+---+---+---+---+---+---+---+---+---+---+---+---+
| Stage#1=ODU3 |           Padding (all zeros)           |
+---+---+---+---+---+---+---+---+---+---+---+---+---+---+---+---+
|           Unreserved Bandwidth at priority 0           |
+---+---+---+---+---+---+---+---+---+---+---+---+---+---+---+---+
|           Unreserved Bandwidth at priority 1           |
+---+---+---+---+---+---+---+---+---+---+---+---+---+---+---+---+
|           Unreserved Bandwidth at priority 2           |
+---+---+---+---+---+---+---+---+---+---+---+---+---+---+---+---+
|           Unreserved Bandwidth at priority 3           |
+---+---+---+---+---+---+---+---+---+---+---+---+---+---+---+---+
|           Unreserved Bandwidth at priority 4           |
+---+---+---+---+---+---+---+---+---+---+---+---+---+---+---+---+

```

```

|           Unreserved Bandwidth at priority 5           |
+-----+-----+-----+-----+-----+-----+-----+
|           Unreserved Bandwidth at priority 6           |
+-----+-----+-----+-----+-----+-----+-----+
|           Unreserved Bandwidth at priority 7           |
+-----+-----+-----+-----+-----+-----+-----+
|           MAX LSP Bandwidth at priority 0              |
+-----+-----+-----+-----+-----+-----+-----+
|           MAX LSP Bandwidth at priority 1              |
+-----+-----+-----+-----+-----+-----+-----+
|           MAX LSP Bandwidth at priority 2              |
+-----+-----+-----+-----+-----+-----+-----+
|           MAX LSP Bandwidth at priority 3              |
+-----+-----+-----+-----+-----+-----+-----+
|           MAX LSP Bandwidth at priority 4              |
+-----+-----+-----+-----+-----+-----+-----+
|           MAX LSP Bandwidth at priority 5              |
+-----+-----+-----+-----+-----+-----+-----+
|           MAX LSP Bandwidth at priority 6              |
+-----+-----+-----+-----+-----+-----+-----+
|           MAX LSP Bandwidth at priority 7              |
+-----+-----+-----+-----+-----+-----+-----+

```

Figure 11: Example 3 - ODUflex advertisement

#### [5.4.](#) Example of single stage muxing

Supposing there is 1 OTU4 component link supporting single stage muxing of ODU1, ODU2, ODU3 and ODUflex, the supported hierarchy can be summarized in a tree as in the following figure. For sake of simplicity we assume that also in this case only priorities 0 and 3 are supported. T, S and TSG fields are not relevant to this example.

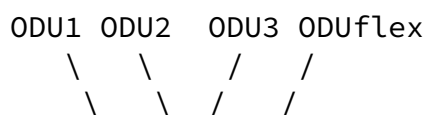





```

|Sig type=ODU4 | #stages= 0 |T|S| TSG |0 0 0|1|0|0|1|0|0|0|0|
+---+---+---+---+---+---+---+---+---+---+---+---+---+---+---+---+
| Unres ODU4 at Prio 0 =1 | Unres ODU4 at Prio 3 =1 |
+---+---+---+---+---+---+---+---+---+---+---+---+---+---+---+---+
| Type = 1 (Unres-fix) | Length = 12 |
+---+---+---+---+---+---+---+---+---+---+---+---+---+---+---+---+
|Sig type=ODU1 | #stages= 1 |T|S| TSG |0 0 0|1|0|0|1|0|0|0|0|
+---+---+---+---+---+---+---+---+---+---+---+---+---+---+---+---+
| Stage#1=ODU4 | Padding (all zeros) |
+---+---+---+---+---+---+---+---+---+---+---+---+---+---+---+---+
| Unres ODU1 at Prio 0 =40 | Unres ODU1 at Prio 3 =40 |
+---+---+---+---+---+---+---+---+---+---+---+---+---+---+---+---+
| Type = 1 (Unres-fix) | Length = 12 |
+---+---+---+---+---+---+---+---+---+---+---+---+---+---+---+---+
|Sig type=ODU2 | #stages= 1 |T|S| TSG |0 0 0|1|0|0|1|0|0|0|0|
+---+---+---+---+---+---+---+---+---+---+---+---+---+---+---+---+
| Stage#1=ODU4 | Padding (all zeros) |
+---+---+---+---+---+---+---+---+---+---+---+---+---+---+---+---+
| Unres ODU2 at Prio 0 =10 | Unres ODU2 at Prio 3 =10 |
+---+---+---+---+---+---+---+---+---+---+---+---+---+---+---+---+
| Type = 1 (Unres-fix) | Length = 12 |
+---+---+---+---+---+---+---+---+---+---+---+---+---+---+---+---+
|Sig type=ODU3 | #stages= 1 |T|S| TSG |0 0 0|1|0|0|1|0|0|0|0|
+---+---+---+---+---+---+---+---+---+---+---+---+---+---+---+---+
| Stage#1=ODU4 | Padding (all zeros) |
+---+---+---+---+---+---+---+---+---+---+---+---+---+---+---+---+
| Unres ODU3 at Prio 0 =2 | Unres ODU3 at Prio 3 =2 |
+---+---+---+---+---+---+---+---+---+---+---+---+---+---+---+---+
| Type = 2 (Unres/MAX-var) | Length = 24 |
+---+---+---+---+---+---+---+---+---+---+---+---+---+---+---+---+
|S. type=ODUflex| #stages= 1 |T|S| TSG |0 0 0|1|0|0|1|0|0|0|0|
+---+---+---+---+---+---+---+---+---+---+---+---+---+---+---+---+
| Stage#1=ODU4 | Padding (all zeros) |
+---+---+---+---+---+---+---+---+---+---+---+---+---+---+---+---+
| Unreserved Bandwidth at priority 0 =100Gbps |
+---+---+---+---+---+---+---+---+---+---+---+---+---+---+---+---+
| Unreserved Bandwidth at priority 3 =100Gbps |
+---+---+---+---+---+---+---+---+---+---+---+---+---+---+---+---+
| MAX LSP Bandwidth at priority 0 =100Gbps |
+---+---+---+---+---+---+---+---+---+---+---+---+---+---+---+---+
| MAX LSP Bandwidth at priority 3 =100Gbps |
+---+---+---+---+---+---+---+---+---+---+---+---+---+---+---+---+

```

Figure 12: Example 4 - Single stage muxing

5.5. Example of multi stage muxing - Unbundled link

Supposing there is 1 OTU4 component link with muxing capabilities as shown in the following figure:

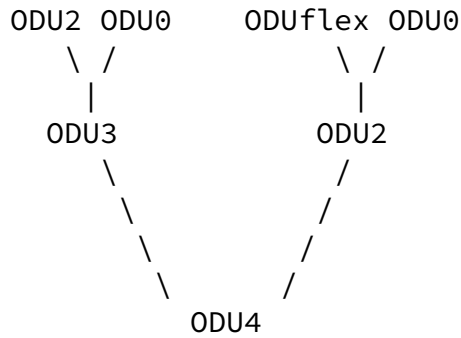

and supported priorities 0 and 3, the advertisement is composed by the following Bandwidth TLVs (T and S fields are not relevant to this example):

```

0                                     1                                     2                                     3
0 1 2 3 4 5 6 7 8 9 0 1 2 3 4 5 6 7 8 9 0 1 2 3 4 5 6 7 8 9 0 1
+-----+-----+-----+-----+-----+-----+-----+-----+-----+-----+
|           Type = 1 (Unres-fix)           |           Length = 8           |
+-----+-----+-----+-----+-----+-----+-----+-----+-----+-----+
|Sig type=ODU4 | #stages= 0 |T|S| 1 |0 0 0|1|0|0|1|0|0|0|0|
+-----+-----+-----+-----+-----+-----+-----+-----+-----+
| Unres ODU4 at Prio 0 =1 | Unres ODU4 at Prio 3 =1 |
+-----+-----+-----+-----+-----+-----+-----+-----+-----+
|           Type = 1 (Unres-fix)           |           Length = 12          |
+-----+-----+-----+-----+-----+-----+-----+-----+-----+
|Sig type=ODU3 | #stages= 1 |T|S| 1 |0 0 0|1|0|0|1|0|0|0|0|
+-----+-----+-----+-----+-----+-----+-----+-----+-----+
| Stage#1=ODU4 |           Padding (all zeros)           |
+-----+-----+-----+-----+-----+-----+-----+-----+-----+
| Unres ODU3 at Prio 0 =2 | Unres ODU3 at Prio 3 =2 |
+-----+-----+-----+-----+-----+-----+-----+-----+-----+
|           Type = 1 (Unres-fix)           |           Length = 12          |
+-----+-----+-----+-----+-----+-----+-----+-----+-----+
|Sig type=ODU2 | #stages= 1 |T|S| 1 |0 0 0|1|0|0|1|0|0|0|0|
+-----+-----+-----+-----+-----+-----+-----+-----+-----+
| Stage#1=ODU4 |           Padding (all zeros)           |
+-----+-----+-----+-----+-----+-----+-----+-----+-----+
| Unres ODU2 at Prio 0 =10 | Unres ODU2 at Prio 3 =10 |
    
```

Internet-Draft

OSPF-TE extensions for OTN support

April 2013

```

+-----+-----+-----+-----+-----+-----+-----+-----+-----+-----+
|           Type = 1 (Unres-fix)           |           Length = 12           |
+-----+-----+-----+-----+-----+-----+-----+-----+-----+-----+
|Sig type=ODU2 | #stages= 2 |T|S| 0 |0 0 0|1|0|0|1|0|0|0|0|
+-----+-----+-----+-----+-----+-----+-----+-----+-----+-----+
| Stage#1=ODU3 | Stage#2=ODU4 |   Padding (all zeros)           |
+-----+-----+-----+-----+-----+-----+-----+-----+-----+-----+
| Unres ODU2 at Prio 0 =8                   | Unres ODU2 at Prio 3 =8         |
+-----+-----+-----+-----+-----+-----+-----+-----+-----+-----+
|           Type = 1 (Unres-fix)           |           Length = 12           |
+-----+-----+-----+-----+-----+-----+-----+-----+-----+-----+
|Sig type=ODU0 | #stages= 2 |T|S| 0 |0 0 0|1|0|0|1|0|0|0|0|
+-----+-----+-----+-----+-----+-----+-----+-----+-----+-----+
| Stage#1=ODU3 | Stage#2=ODU4 |   Padding (all zeros)           |
+-----+-----+-----+-----+-----+-----+-----+-----+-----+-----+
| Unres ODU0 at Prio 0 =64                   | Unres ODU0 at Prio 3 =64       |
+-----+-----+-----+-----+-----+-----+-----+-----+-----+-----+
|           Type = 1 (Unres-fix)           |           Length = 12           |
+-----+-----+-----+-----+-----+-----+-----+-----+-----+-----+
|Sig type=ODU0 | #stages= 2 |T|S| 0 |0 0 0|1|0|0|1|0|0|0|0|
+-----+-----+-----+-----+-----+-----+-----+-----+-----+-----+
| Stage#1=ODU2 | Stage#2=ODU4 |   Padding (all zeros)           |
+-----+-----+-----+-----+-----+-----+-----+-----+-----+-----+
| Unres ODU0 at Prio 0 =80                   | Unres ODU0 at Prio 3 =80       |
+-----+-----+-----+-----+-----+-----+-----+-----+-----+-----+
|           Type = 2 (Unres/MAX-var)       |           Length = 24           |
+-----+-----+-----+-----+-----+-----+-----+-----+-----+-----+
|S.type=ODUflex | #stages= 2 |T|S| 0 |0 0 0|1|0|0|1|0|0|0|0|
+-----+-----+-----+-----+-----+-----+-----+-----+-----+-----+
| Stage#1=ODU2 | Stage#2=ODU4 |   Padding (all zeros)           |
+-----+-----+-----+-----+-----+-----+-----+-----+-----+-----+
|           Unreserved Bandwidth at priority 0 =100Gbps           |
+-----+-----+-----+-----+-----+-----+-----+-----+-----+-----+
|           Unreserved Bandwidth at priority 3 =100Gbps           |
+-----+-----+-----+-----+-----+-----+-----+-----+-----+-----+
|           MAX LSP Bandwidth at priority 0 =10Gbps               |
+-----+-----+-----+-----+-----+-----+-----+-----+-----+-----+
|           MAX LSP Bandwidth at priority 3 =10Gbps               |
+-----+-----+-----+-----+-----+-----+-----+-----+-----+-----+

```

Figure 13: Example 5 - Multi stage muxing - Unbundled link

[5.6.](#) Example of multi stage muxing - Bundled links

In this example 2 OTU4 component links with the same supported TSG and homogeneous muxing hierarchies are considered. The following muxing capabilities trees are supported:

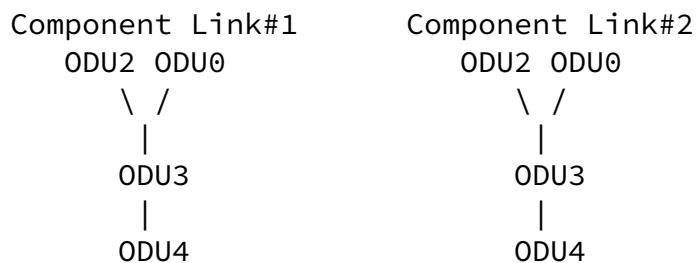

Considering only supported priorities 0 and 3, the advertisement is as follows (T, S and TSG fields are not relevant to this example):

```

0                               1                               2                               3
0 1 2 3 4 5 6 7 8 9 0 1 2 3 4 5 6 7 8 9 0 1 2 3 4 5 6 7 8 9 0 1
+-----+-----+-----+-----+-----+-----+-----+-----+
|           Type = 1 (Unres-fix)           |           Length = 8           |
+-----+-----+-----+-----+-----+-----+-----+-----+
|Sig type=ODU4 | #stages= 0 |T|S| TSG |0 0 0|1|0|0|1|0|0|0|0|
+-----+-----+-----+-----+-----+-----+-----+-----+
| Unres ODU4 at Prio 0 =2 | Unres ODU4 at Prio 3 =2 |
+-----+-----+-----+-----+-----+-----+-----+-----+
|           Type = 1 (Unres-fix)           |           Length = 12          |
+-----+-----+-----+-----+-----+-----+-----+-----+
|Sig type=ODU3 | #stages= 1 |T|S| TSG |0 0 0|1|0|0|1|0|0|0|0|
+-----+-----+-----+-----+-----+-----+-----+-----+
| Stage#1=ODU4 |           Padding (all zeros)           |
+-----+-----+-----+-----+-----+-----+-----+-----+
| Unres ODU3 at Prio 0 =4 | Unres ODU3 at Prio 3 =4 |
+-----+-----+-----+-----+-----+-----+-----+-----+
|           Type = 1 (Unres-fix)           |           Length = 12          |
+-----+-----+-----+-----+-----+-----+-----+-----+
|Sig type=ODU2 | #stages= 2 |T|S| TSG |0 0 0|1|0|0|1|0|0|0|0|
+-----+-----+-----+-----+-----+-----+-----+-----+
| Stage#1=ODU3 | Stage#2=ODU4 |           Padding (all zeros)           |
+-----+-----+-----+-----+-----+-----+-----+-----+
| Unres ODU2 at Prio 0 =16 | Unres ODU2 at Prio 3 =16 |
+-----+-----+-----+-----+-----+-----+-----+-----+
|           Type = 1 (Unres-fix)           |           Length = 12          |
+-----+-----+-----+-----+-----+-----+-----+-----+
|Sig type=ODU0 | #stages= 2 |T|S| TSG |0 0 0|1|0|0|1|0|0|0|0|

```

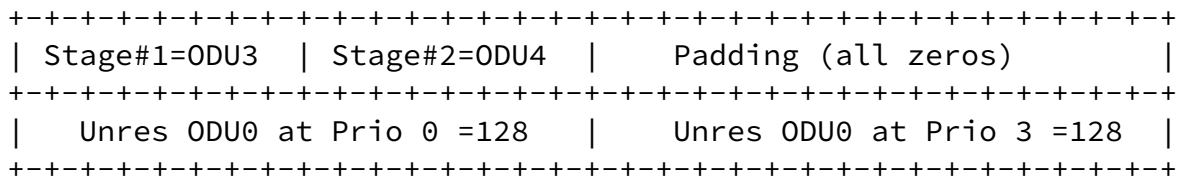
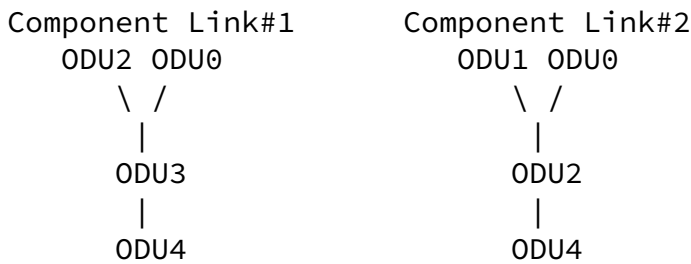

Figure 14: Example 6 - Multi stage muxing - Bundled links

5.7. Example of component links with non homogeneous hierarchies

In this example 2 OTU4 component links with the same supported TSG and non homogeneous muxing hierarchies are considered. The following muxing capabilities trees are supported:



Considering only supported priorities 0 and 3, the advertisement uses two different ISCDs, one for each hierarchy (T, S and TSG fields are not relevant to this example). In the following figure, the SCSI of each ISCD is shown:

SCSI of ISCD 1 - Component Link#1

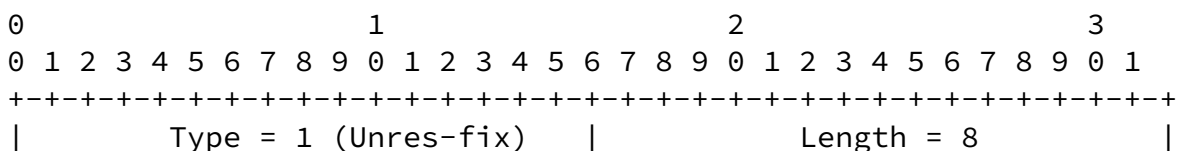

```

+-----+-----+-----+-----+-----+-----+-----+-----+-----+-----+
|Sig type=ODU4 | #stages= 0 |T|S| TSG |0 0 0|1|0|0|1|0|0|0|0|
+-----+-----+-----+-----+-----+-----+-----+-----+-----+-----+
| Unres ODU4 at Prio 0 =1 | Unres ODU4 at Prio 3 =1 |
+-----+-----+-----+-----+-----+-----+-----+-----+-----+-----+
| Type = 1 (Unres-fix) | Length = 12 |
+-----+-----+-----+-----+-----+-----+-----+-----+-----+
|Sig type=ODU3 | #stages= 1 |T|S| TSG |0 0 0|1|0|0|1|0|0|0|0|
+-----+-----+-----+-----+-----+-----+-----+-----+-----+
| Stage#1=ODU4 | Padding (all zeros) |
+-----+-----+-----+-----+-----+-----+-----+-----+-----+
| Unres ODU3 at Prio 0 =2 | Unres ODU3 at Prio 3 =2 |
+-----+-----+-----+-----+-----+-----+-----+-----+-----+
| Type = 1 (Unres-fix) | Length = 12 |
+-----+-----+-----+-----+-----+-----+-----+-----+-----+
|Sig type=ODU2 | #stages= 2 |T|S| TSG |0 0 0|1|0|0|1|0|0|0|0|
+-----+-----+-----+-----+-----+-----+-----+-----+-----+
| Stage#1=ODU3 | Stage#2=ODU4 | Padding (all zeros) |
+-----+-----+-----+-----+-----+-----+-----+-----+-----+
| Unres ODU2 at Prio 0 =8 | Unres ODU2 at Prio 3 =8 |
+-----+-----+-----+-----+-----+-----+-----+-----+-----+
| Type = 1 (Unres-fix) | Length = 12 |
+-----+-----+-----+-----+-----+-----+-----+-----+-----+
|Sig type=ODU0 | #stages= 2 |T|S| TSG |0 0 0|1|0|0|1|0|0|0|0|
+-----+-----+-----+-----+-----+-----+-----+-----+-----+
| Stage#1=ODU3 | Stage#2=ODU4 | Padding (all zeros) |
+-----+-----+-----+-----+-----+-----+-----+-----+-----+

```

```

| Unres ODU0 at Prio 0 =64 | Unres ODU0 at Prio 3 =64 |
+-----+-----+-----+-----+-----+-----+-----+-----+-----+

```

SCSI of ISCD 2 - Component Link#2

```

0 1 2 3 4 5 6 7 8 9 0 1 2 3 4 5 6 7 8 9 0 1 2 3 4 5 6 7 8 9 0 1
+-----+-----+-----+-----+-----+-----+-----+-----+-----+
| Type = 1 (Unres-fix) | Length = 8 |
+-----+-----+-----+-----+-----+-----+-----+-----+-----+
|Sig type=ODU4 | #stages= 0 |T|S| TSG |0 0 0|1|0|0|1|0|0|0|0|
+-----+-----+-----+-----+-----+-----+-----+-----+-----+
| Unres ODU4 at Prio 0 =1 | Unres ODU4 at Prio 3 =1 |
+-----+-----+-----+-----+-----+-----+-----+-----+-----+

```

```

|          Type = 1 (Unres-fix)          |          Length = 12          |
+-----+-----+-----+-----+-----+-----+-----+-----+-----+-----+
|Sig type=ODU2 | #stages= 1 |T|S| TSG |0 0 0 |1|0|0|1|0|0|0|0|
+-----+-----+-----+-----+-----+-----+-----+-----+-----+-----+
| Stage#1=ODU4 |          Padding (all zeros)          |
+-----+-----+-----+-----+-----+-----+-----+-----+-----+
| Unres ODU2 at Prio 0 =10      | Unres ODU2 at Prio 3 =10      |
+-----+-----+-----+-----+-----+-----+-----+-----+-----+
|          Type = 1 (Unres-fix)          |          Length = 12          |
+-----+-----+-----+-----+-----+-----+-----+-----+-----+-----+
|Sig type=ODU1 | #stages= 2 |T|S| TSG |0 0 0 |1|0|0|1|0|0|0|0|
+-----+-----+-----+-----+-----+-----+-----+-----+-----+-----+
| Stage#1=ODU2 | Stage#2=ODU4 |          Padding (all zeros)          |
+-----+-----+-----+-----+-----+-----+-----+-----+-----+
| Unres ODU1 at Prio 0 =40      | Unres ODU1 at Prio 3 =40      |
+-----+-----+-----+-----+-----+-----+-----+-----+-----+
|          Type = 1 (Unres-fix)          |          Length = 12          |
+-----+-----+-----+-----+-----+-----+-----+-----+-----+-----+
|Sig type=ODU0 | #stages= 2 |T|S| TSG |0 0 0 |1|0|0|1|0|0|0|0|
+-----+-----+-----+-----+-----+-----+-----+-----+-----+-----+
| Stage#1=ODU2 | Stage#2=ODU4 |          Padding (all zeros)          |
+-----+-----+-----+-----+-----+-----+-----+-----+-----+
| Unres ODU0 at Prio 0 =80      | Unres ODU0 at Prio 3 =80      |
+-----+-----+-----+-----+-----+-----+-----+-----+-----+

```

Figure 15: Example 7 - Multi stage muxing - Non homogeneous hierarchies

## 6. Compatibility

All implementations of this document MAY support also advertisement as defined in [\[RFC4328\]](#). When nodes support both advertisement

methods, implementations MUST support the configuration of which advertisement method is followed. The choice of which is used is based on policy and is out of scope of the document. This enables nodes following each method to identify similar supporting nodes and compute paths using only the appropriate nodes.



## 7. Security Considerations

This document, as [RFC4203], specifies the contents of Opaque LSAs in OSPFv2. As Opaque LSAs are not used for SPF computation or normal routing, the extensions specified here have no direct effect on IP routing. Tampering with GMPLS TE LSAs may have an effect on the underlying transport (optical and/or SONET-SDH) network. [RFC3630] suggests mechanisms such as [RFC2154] to protect the transmission of this information, and those or other mechanisms should be used to secure and/or authenticate the information carried in the Opaque LSAs.

For security threats, defensive techniques, monitoring/detection/reporting of security attacks and requirements please refer to [RFC5920] .

## 8. IANA Considerations

Upon approval of this document, IANA will make the assignment in the "Switching Types" section of the "GMPLS Signaling Parameters" registry located at <http://www.iana.org/assignments/gmpls-sig-parameters>:

Value	Type	Reference
110 (*)	OTN-TDM capable (OTN-TDM)	[This.I-D]

(\*) Suggested value

This document defines 2 new TLVs that are carried in Interface Switching Capability Descriptors [RFC4203] with Signal Type OTN-TDM. Each TLV includes a 16-bit type identifier (the T-field). The same T-field values are applicable to the new sub-TLV.

Upon approval of this document, IANA will create and maintain a new registry, the "sub-TLVs of the OTN-TDM Interface Switching Capability Descriptor TLV" registry under the "Open Shortest Path First (OSPF) Traffic Engineering TLVs" registry, see <http://www.iana.org/>

assignments/ospf-traffic-eng-tlvs/ospf-traffic-eng-tlvs.xml, with the TLV types as follows:

This document defines new TLV types as follows:

- TLV Type = 1
- TLV Name = Unreserved Bandwidth for fixed containers
- allowed on ISCD sub-TLV
  
- TLV Type = 2
- TLV Name = Unreserved Bandwidth for fixed containers
- allowed on ISCD sub-TLV

New TLV type values may be allocated only by an IETF Consensus action. The request Registration Procedures are Standards Action.

## 9. Contributors

Xiaobing Zi, Huawei Technologies

Email: zixiaobing@huawei.com

Francesco Fondelli, Ericsson

Email: francesco.fondelli@ericsson.com

Marco Corsi

EMail: corsi.marco@gmail.com

Eve Varma, Alcatel-Lucent

EMail: eve.varma@alcatel-lucent.com

Jonathan Sadler, Tellabs

EMail: jonathan.sadler@tellabs.com

Internet-Draft

OSPF-TE extensions for OTN support

April 2013

Lyndon Ong, Ciena

EMail: [lyong@ciena.com](mailto:lyong@ciena.com)

Ashok Kunjidhapatham

[akunjidhapatham@infinera.com](mailto:akunjidhapatham@infinera.com)

Snigdho Bardalai

[sbardalai@infinera.com](mailto:sbardalai@infinera.com)

Steve Balls

[Steve.Balls@metaswitch.com](mailto:Steve.Balls@metaswitch.com)

Jonathan Hardwick

[Jonathan.Hardwick@metaswitch.com](mailto:Jonathan.Hardwick@metaswitch.com)

Xihua Fu

[fu.xihua@zte.com.cn](mailto:fu.xihua@zte.com.cn)

Cyril Margaria

[cyril.margaria@nsn.com](mailto:cyril.margaria@nsn.com)

Malcolm Betts

## 10. Acknowledgements

The authors would like to thank Fred Gruman and Lou Berger for the precious comments and suggestions.

## 11. References

### 11.1. Normative References

- [RFC2119] Bradner, S., "Key words for use in RFCs to Indicate Requirement Levels", [BCP 14](#), [RFC 2119](#), March 1997.
- [RFC3630] Katz, D., Kompella, K., and D. Yeung, "Traffic Engineering (TE) Extensions to OSPF Version 2", [RFC 3630](#), September 2003.
- [RFC4202] Kompella, K. and Y. Rekhter, "Routing Extensions in Support of Generalized Multi-Protocol Label Switching (GMPLS)", [RFC 4202](#), October 2005.
- [RFC4203] Kompella, K. and Y. Rekhter, "OSPF Extensions in Support of Generalized Multi-Protocol Label Switching (GMPLS)", [RFC 4203](#), October 2005.
- [RFC4328] Papadimitriou, D., "Generalized Multi-Protocol Label Switching (GMPLS) Signaling Extensions for G.709 Optical Transport Networks Control", [RFC 4328](#), January 2006.

### 11.2. Informative References

- [G.709-2012] ITU-T, "Draft revised G.709, version 4", consented by ITU-T in 2012.
- [OTN-FWK] F.Zhang, D.Li, H.Li, S.Belotti, D.Ceccarelli, "Framework

for GMPLS and PCE Control of G.709 Optical Transport networks, work in progress  
[draft-ietf-ccamp-gmpls-g709-framework-11](#)", November 2012.

[OTN-INFO]

S.Belotti, P.Grandi, D.Ceccarelli, D.Caviglia, F.Zhang, D.Li, "Information model for G.709 Optical Transport Networks (OTN), work in progress  
[draft-ietf-ccamp-otn-g709-info-model-05](#)", November 2012.

[OTN-SIG] F.Zhang, G.Zhang, S.Belotti, D.Ceccarelli, K.Pithewan, "Generalized Multi-Protocol Label Switching (GMPLS)

Ceccarelli, et al.

Expires October 6, 2013

[Page 32]

---

Internet-Draft

OSPF-TE extensions for OTN support

April 2013

Signaling Extensions for the evolving G.709 Optical Transport Networks Control, work in progress  
[draft-ietf-ccamp-gmpls-signaling-g709v3-05](#)", November 2012.

[RFC2154] Murphy, S., Badger, M., and B. Wellington, "OSPF with Digital Signatures", [RFC 2154](#), June 1997.

[RFC5920] Fang, L., "Security Framework for MPLS and GMPLS Networks", [RFC 5920](#), July 2010.

[RFC6163] Lee, Y., Bernstein, G., and W. Imajuku, "Framework for GMPLS and Path Computation Element (PCE) Control of Wavelength Switched Optical Networks (WSOs)", [RFC 6163](#), April 2011.

[RFC6566] Lee, Y., Bernstein, G., Li, D., and G. Martinelli, "A Framework for the Control of Wavelength Switched Optical Networks (WSOs) with Impairments", [RFC 6566](#), March 2012.

#### Authors' Addresses

Daniele Ceccarelli (editor)  
Ericsson  
Via A. Negrone 1/A  
Genova - Sestri Ponente  
Italy

Email: danielle.ceccarelli@ericsson.com

Diego Caviglia  
Ericsson  
Via A. Negrone 1/A  
Genova - Sestri Ponente  
Italy

Email: diego.caviglia@ericsson.com

Ceccarelli, et al.

Expires October 6, 2013

[Page 33]

---

Internet-Draft

OSPF-TE extensions for OTN support

April 2013

Fatai Zhang  
Huawei Technologies  
F3-5-B R&D Center, Huawei Base  
Shenzhen 518129 P.R.China Bantian, Longgang District  
Phone: +86-755-28972912

Email: zhangfatai@huawei.com

Dan Li  
Huawei Technologies  
F3-5-B R&D Center, Huawei Base  
Shenzhen 518129 P.R.China Bantian, Longgang District  
Phone: +86-755-28973237

Email: danli@huawei.com

Sergio Belotti  
Alcatel-Lucent  
Via Trento, 30  
Vimercate

Italy

Email: [sergio.belotti@alcatel-lucent.com](mailto:sergio.belotti@alcatel-lucent.com)

Pietro Vittorio Grandi  
Alcatel-Lucent  
Via Trento, 30  
Vimercate  
Italy

Email: [pietro\\_vittorio.grandi@alcatel-lucent.com](mailto:pietro_vittorio.grandi@alcatel-lucent.com)

Rajan Rao  
Infinera Corporation  
169, Java Drive  
Sunnyvale, CA-94089  
USA

Email: [r rao@infinera.com](mailto:r rao@infinera.com)

Ceccarelli, et al.

Expires October 6, 2013

[Page 34]

---

Internet-Draft

OSPF-TE extensions for OTN support

April 2013

Khuzema Pithewan  
Infinera Corporation  
169, Java Drive  
Sunnyvale, CA-94089  
USA

Email: [kpithewan@infinera.com](mailto:kpithewan@infinera.com)

John E Drake  
Juniper

Email: [jdrake@juniper.net](mailto:jdrake@juniper.net)

