

DetNet
Finn
Internet-Draft
Ltd
Intended status: Standards Track
Thubert
Expires: December 31, 2017
Cisco
Varga
Farkas
Ericsson
2017

N.
Huawei Technologies Co.
P.
B.
J.
June 29,

Deterministic Networking Architecture
draft-ietf-detnet-architecture-02

Abstract

Deterministic Networking (DetNet) provides a capability to carry specified unicast or multicast data flows for real-time applications with extremely low data loss rates and bounded latency. Techniques used include: 1) reserving data plane resources for individual (or aggregated) DetNet flows in some or all of the intermediate nodes (e.g. bridges or routers) along the path of the flow; 2) providing explicit routes for DetNet flows that do not rapidly change with the network topology; and 3) distributing data from DetNet flow packets over time and/or space to ensure delivery of each packet's data' in spite of the loss of a path. The capabilities can be managed by configuration, or by manual or automatic network management.

Status of This Memo

This Internet-Draft is submitted in full conformance with the provisions of [BCP 78](#) and [BCP 79](#).

Internet-Drafts are working documents of the Internet Engineering Task Force (IETF). Note that other groups may also distribute working documents as Internet-Drafts. The list of current Internet-Drafts is at <http://datatracker.ietf.org/drafts/current/>.

Internet-Drafts are draft documents valid for a maximum of six months and may be updated, replaced, or obsoleted by other documents at any time. It is inappropriate to use Internet-Drafts as reference material or to cite them other than as "work in progress."

This Internet-Draft will expire on December 31, 2017.

Copyright Notice

Copyright (c) 2017 IETF Trust and the persons identified as the document authors. All rights reserved.

This document is subject to [BCP 78](#) and the IETF Trust's Legal Provisions Relating to IETF Documents (<http://trustee.ietf.org/license-info>) in effect on the date of publication of this document. Please review these documents carefully, as they describe your rights and restrictions with respect to this document. Code Components extracted from this document must include Simplified BSD License text as described in Section 4.e of the Trust Legal Provisions and are provided without warranty as described in the Simplified BSD License.

Table of Contents

1.	Introduction	3
2.	Terminology	4
2.1.	Terms used in this document	4
2.2.	IEEE 802 TSN to DetNet dictionary	6
3.	Providing the DetNet Quality of Service	7
3.1.	Primary goals defining the DetNet QoS	7
3.2.	Mechanisms to achieve DetNet Qos	9
3.2.1.	Congestion protection	9
3.2.2.	Explicit routes	9
3.2.3.	Jitter Reduction	10
3.2.4.	Packet Replication and Elimination	11
3.3.	Secondary goals for DetNet	12
3.3.1.	Coexistence with normal traffic	12
3.3.2.	Fault Mitigation	13
4.	DetNet Architecture	14
4.1.	DetNet stack model	14
4.1.1.	Representative Protocol Stack Model	14

16	4.1.2. DetNet Data Plane Overview
18	4.1.3. Network reference model
19	4.2. DetNet systems
19	4.2.1. End system
20	4.2.2. DetNet edge, relay, and transit nodes
21	4.3. DetNet flows
21	4.3.1. DetNet flow types
21	4.3.2. Source guarantees
23	4.3.3. Incomplete Networks
23	4.4. Traffic Engineering for DetNet
23	4.4.1. The Application Plane
24	4.4.2. The Controller Plane
24	4.4.3. The Network Plane
25	4.5. Queuing, Shaping, Scheduling, and Preemption

4.6.	Service instance	26
4.7.	Flow identification at technology borders	27
4.7.1.	Exporting flow identification	27
4.7.2.	Flow attribute mapping between layers	29
4.7.3.	Flow-ID mapping examples	30
4.8.	Advertising resources, capabilities and adjacencies	32
4.9.	Provisioning model	32
4.9.1.	Centralized Path Computation and Installation	32
4.9.2.	Distributed Path Setup	32
4.10.	Scaling to larger networks	33
4.11.	Connected islands vs. networks	33
4.12.	Compatibility with Layer-2	33
5.	Open Questions	34
5.1.	Flat vs. hierarchical control	34
5.2.	Peer-to-peer reservation protocol	34
5.3.	Wireless media interactions	35
5.4.	Packet encoding for service protection	35
6.	Security Considerations	35
7.	Privacy Considerations	36
8.	IANA Considerations	36
9.	Acknowledgements	36
10.	Access to IEEE 802.1 documents	37
11.	Informative References	37
	Authors' Addresses	42

[1.](#) Introduction

Deterministic Networking (DetNet) is a service that can be offered

by

a network to DetNet flows. DetNet provides these flows extremely low packet loss rates and assured maximum end-to-end delivery latency. This is accomplished by dedicating network resources such as link bandwidth and buffer space to DetNet flows and/or classes of DetNet flows, and by replicating packets along multiple paths. Unused reserved resources are available to non-DetNet packets.

The Deterministic Networking Problem Statement

[\[I-D.ietf-detnet-problem-statement\]](#) introduces Deterministic Networking, and Deterministic Networking Use Cases

[\[I-D.ietf-detnet-use-cases\]](#) summarizes the need for it. See [\[I-D.dt-detnet-dp-alt\]](#) for a discussion of specific techniques that can be used to identify DetNet Flows and assign them to specific paths through a network.

A goal of DetNet is a converged network in all respects. That is, the presence of DetNet flows does not preclude non-DetNet flows, and the benefits offered DetNet flows should not, except in extreme cases, prevent existing QoS mechanisms from operating in a normal fashion, subject to the bandwidth required for the DetNet flows. A

single source-destination pair can trade both DetNet and non-DetNet flows. End systems and applications need not instantiate special interfaces for DetNet flows. Networks are not restricted to certain topologies; connectivity is not restricted. Any application that generates a data flow that can be usefully characterized as having a maximum bandwidth should be able to take advantage of DetNet, as long as the necessary resources can be reserved. Reservations can be made by the application itself, via network management, by an applications controller, or by other means.

Many applications of interest to Deterministic Networking require the ability to synchronize the clocks in end systems to a sub-microsecond accuracy. Some of the queue control techniques defined in [Section 4.5](#) also require time synchronization among relay and transit nodes. The means used to achieve time synchronization are not addressed in this document. DetNet should accommodate various synchronization techniques and profiles that are defined elsewhere to solve exchange time in different market segments.

The present document is an individual contribution, but it is intended by the authors for adoption by the DetNet working group.

2. Terminology

2.1. Terms used in this document

The following special terms are used in this document in order to avoid the assumption that a given element in the architecture does or does not have Internet Protocol stack, functions as a router, bridge, firewall, or otherwise plays a particular role at Layer-2 or higher.

App-flow

The native format of a DetNet flow.

destination

An end system capable of receiving a DetNet flow.

DetNet domain

The portion of a network that is DetNet aware. It includes end systems and other DetNet nodes.

DetNet flow

A DetNet flow is a sequence of packets to which the DetNet

service is to be provided.

DetNet compound flow and DetNet member flow

A DetNet compound flow is a DetNet flow that has been separated into multiple duplicate DetNet member flows, which

Finn, et al.
4]

Expires December 31, 2017

[Page

are eventually merged back into a single DetNet compound flow, at the DetNet transport layer. "Compound" and "member" are strictly relative to each other, not absolutes; a DetNet compound flow comprising multiple DetNet member flows can, in turn, be a member of a higher-order compound.

DetNet intermediate node

A DetNet relay node or transit node.

DetNet edge node

An instance of a DetNet relay node that includes either a DetNet service layer proxy function for DetNet service protection (e.g. the addition or removal of packet sequencing information) for one or more end systems, or starts or terminates congestion protection at the DetNet transport layer, analogous to a Label Edge Router (LER).

DetNet-UNI

User-to-Network Interface with DetNet specific functionalities. It is a packet-based reference point and may provide multiple functions like encapsulation, status, synchronization, etc.

end system

Commonly called a "host" or "node" in IETF documents, and an "end station" in IEEE 802 documents. End systems of interest to this document are either sources or destinations of DetNet flows. An end system may or may not be DetNet transport layer aware or DetNet service layer aware.

link

A connection between two DetNet nodes. It may be composed of a physical link or a sub-network technology that can provide appropriate traffic delivery for DetNet flows.

DetNet node

A DetNet aware end system, transit node, or relay node. "DetNet" may be omitted in some text.

Detnet relay node

A DetNet node including a service layer function that interconnects different DetNet transport layer paths to provide service protection. A DetNet relay node can be a bridge, a router, a firewall, or any other system that participates in the DetNet service layer. It typically incorporates DetNet transport layer functions as well, in

which case it is collocated with a transit node.

Finn, et al.
5]

Expires December 31, 2017

[Page

reservation

A trail of configuration between source to destination(s) through transit nodes and subnets associated with a DetNet flow, to provide congestion protection.

DetNet service layer

The layer at which service protection is provided, either packet sequencing, replication, and elimination ([Section 3.2.4](#)) or network coding ([Section 5.4](#)).

source

An end system capable of sourcing a DetNet flow.

DetNet transit node

utilizes A node operating at the DetNet transport layer, that

link layer and/or network layer switching across multiple links and/or sub-networks to provide paths for DetNet

service

layer functions. Optionally provides congestion protection over those paths. An MPLS LSR is an example of a DetNet transit node.

DetNet transport layer

The layer that optionally provides congestion protection for DetNet flows over paths provided by the underlying network.

TSN

Time-Sensitive Networking, TSN is a Task Group of the IEEE 802.1 Working Group.

2.2. IEEE 802 TSN to DetNet dictionary

This section also serves as a dictionary for translating from the terms used by the IEEE 802 Time-Sensitive Networking (TSN) Task Group to those of the DetNet WG.

Listener

The IEEE 802 term for a destination of a DetNet flow.

relay system

The IEEE 802 term for a DetNet intermediate node.

Stream

The IEEE 802 term for a DetNet flow.

Talker

The IEEE 802 term for the source of a DetNet flow.

3. Providing the DetNet Quality of Service

3.1. Primary goals defining the DetNet QoS

The DetNet Quality of Service can be expressed in terms of:

- o Minimum and maximum end-to-end latency from source to destination;
timely delivery and jitter avoidance derive from these constraints
- o Probability of loss of a packet, under various assumptions as to the operational states of the nodes and links. A derived property
is whether it is acceptable to deliver a duplicate packet, which is an inherent risk in highly reliable and/or broadcast transmissions

It is a distinction of DetNet that it is concerned solely with worst-case values for the end-to-end latency. Average, mean, or typical values are of no interest, because they do not affect the ability of a real-time system to perform its tasks. In general, a trivial priority-based queuing scheme will give better average latency to a data flow than DetNet, but of course, the worst-case latency can be essentially unbounded.

Three techniques are used by DetNet to provide these qualities of service:

- o Congestion protection ([Section 3.2.1](#)).
- o Explicit routes ([Section 3.2.2](#)).
- o Service protection ([Section 3.2.4](#)).

Congestion protection operates by reserving resources along the path of a DetNet Flow, e.g. buffer space or link bandwidth. Congestion protection greatly reduces, or even eliminates entirely, packet loss due to output packet congestion within the network, but it can only be supplied to a DetNet flow that is limited at the source to a maximum packet size and transmission rate.

Congestion protection addresses both of the DetNet QoS requirements (latency and packet loss). Given that DetNet nodes have a finite amount of buffer space, congestion protection necessarily results in a maximum end-to-end latency. It also addresses the largest contribution to packet loss, which is buffer congestion.

After congestion, the most important contributions to packet loss are typically from random media errors and equipment failures. Service

protection is the name for the mechanisms used by DetNet to address

Finn, et al.
7]

Expires December 31, 2017

[Page

these losses. The mechanisms employed are constrained by the requirement to meet the users' latency requirements. Packet replication and elimination ([Section 3.2.4](#)) packet encoding [Section 5.4](#) are described in this document to provide service protection; others may be found. Both mechanisms distribute the contents of DetNet flows over multiple paths in time and/or space,

so

that the loss of some of the paths does need not cause the loss of any packets. The paths are typically (but not necessarily) explicit routes, so that they cannot suffer temporary interruptions caused by the reconvergence of routing or bridging protocols.

These three techniques can be applied independently, giving eight possible combinations, including none (no DetNet), although some combinations are of wider utility than others. This separation

keeps

the protocol stack coherent and maximizes interoperability with existing and developing standards in this (IETF) and other Standards Development Organizations. Some examples of typical expected combinations:

- o Explicit routes plus service protection are exactly the techniques

- employed by [\[HSR-PRP\]](#). Explicit routes are achieved by limiting the physical topology of the network, and the sequentialization, replication, and duplicate elimination are facilitated by packet tags added at the front or the end of Ethernet frames.

- o Congestion protection alone is offered by IEEE 802.1 Audio Video bridging [\[IEEE802.1BA-2011\]](#). As long as the network

suffers

- no failures, zero congestion loss can be achieved through the use of a reservation protocol (MSRP), shapers in every bridge, and a bit of network calculus.

- o Using all three together gives maximum protection.

There are, of course, simpler methods available (and employed, today)

to achieve levels of latency and packet loss that are satisfactory for many applications. Prioritization and over-provisioning is one such technique. However, these methods generally work best in the absence of any significant amount of non-critical traffic in the network (if, indeed, such traffic is supported at all), or work only if the critical traffic constitutes only a small portion of the network's theoretical capacity, or work only if all systems are functioning properly, or in the absence of actions by end systems that disrupt the network's operations.

There are any number of methods in use, defined, or in progress for accomplishing each of the above techniques. It is expected that this

DetNet Architecture will assist various vendors, users, and/or "vertical" Standards Development Organizations (dedicated to a single

Finn, et al.
8]

Expires December 31, 2017

[Page

industry) to make selections among the available means of implementing DetNet networks.

3.2. Mechanisms to achieve DetNet Qos

3.2.1. Congestion protection

The primary means by which DetNet achieves its QoS assurances is to reduce, or even completely eliminate, congestion at an output port as

a cause of packet loss. Given that a DetNet flow cannot be throttled, this can be achieved only by the provision of sufficient buffer storage at each hop through the network to ensure that no packets are dropped due to a lack of buffer storage.

Ensuring adequate buffering requires, in turn, that the source, and every intermediate node along the path to the destination (or nearly every node -- see [Section 4.3.3](#)) be careful to regulate its output to

not exceed the data rate for any DetNet flow, except for brief periods when making up for interfering traffic. Any packet sent ahead of its time potentially adds to the number of buffers required by the next hop, and may thus exceed the resources allocated for a particular DetNet flow.

The low-level mechanisms described in [Section 4.5](#) provide the necessary regulation of transmissions by an end system or intermediate node to provide congestion protection. The reservation of the bandwidth and buffers for a DetNet flow requires the provisioning described in [Section 4.9](#). A DetNet node may have other resources requiring allocation and/or scheduling, that might otherwise be over-subscribed and trigger the rejection of a reservation.

3.2.2. Explicit routes

In networks controlled by typical peer-to-peer protocols such as IEEE

802.1 ISIS bridged networks or IETF OSPF routed networks, a network topology event in one part of the network can impact, at least briefly, the delivery of data in parts of the network remote from the

failure or recovery event. Thus, even redundant paths through a network, if controlled by the typical peer-to-peer protocols, do not eliminate the chances of brief losses of contact.

Many real-time networks rely on physical rings or chains of two-port devices, with a relatively simple ring control protocol. This supports redundant paths for service protection with a minimum of wiring. As an additional benefit, ring topologies can often utilize different topology management protocols than those used for a mesh network, with a consequent reduction in the response time to

topology

Finn, et al.
9]

Expires December 31, 2017

[Page

changes. Of course, this comes at some cost in terms of increased hop count, and thus latency, for the typical path.

In order to get the advantages of low hop count and still ensure against even very brief losses of connectivity, DetNet employs explicit routes, where the path taken by a given DetNet flow does not change, at least immediately, and likely not at all, in response to network topology events. Service protection ([Section 3.2.4](#) or [Section 5.4](#)) over explicit routes provides a high likelihood of continuous connectivity. Explicit routes are commonly used in MPLS TE LSPs.

3.2.3. Jitter Reduction

A core objective of DetNet is to enable the convergence of Non-IP networks onto a common network infrastructure. This requires the accurate emulation of currently deployed mission-specific networks, which typically rely on point-to-point analog (e.g. 4-20mA modulation) and serial-digital cables (or buses) for highly reliable, synchronized and jitter-free communications. While the latency of analog transmissions is basically the speed of light, legacy serial links are usually slow (in the order of Kbps) compared to, say, GigE, and some latency is usually acceptable. What is not acceptable is the introduction of excessive jitter, which may, for instance, affect the stability of control systems.

Applications that are designed to operate on serial links usually do not provide services to recover the jitter, because jitter simply does not exist there. Streams of information are expected to be delivered in-order and the precise time of reception influences the processes. In order to converge such existing applications, there is a desire to emulate all properties of the serial cable, such as clock transportation, perfect flow isolation and fixed latency. While minimal jitter (in the form of specifying minimum, as well as maximum, end-to-end latency) is supported by DetNet, there are practical limitations on packet-based networks in this regard. In general, users are encouraged to use, instead of, "do this when you get the packet," a combination of:

- o Sub-microsecond time synchronization among all source and destination end systems, and
- o Time-of-execution fields in the application packets.

Jitter reduction is provided by the mechanisms described in [Section 4.5](#) that also provide congestion protection.

3.2.4. Packet Replication and Elimination

After congestion loss has been eliminated, the most important causes of packet loss are random media and/or memory faults, and equipment failures. Both causes of packet loss can be greatly reduced by spreading the data in a packet over multiple transmissions. One such method for service protection is described in this section, which sends the same packets over multiple paths. See also [Section 5.4](#).

Packet replication and elimination, also known as seamless redundancy

[[HSR-PRP](#)], or 1+1 hitless protection, is a function of the DetNet service layer. It involves three capabilities:

- o Providing sequencing information, once, at or near the source, to the packets of a DetNet compound flow. This may be done by adding a sequence number or time stamp as part of DetNet, or may be inherent in the packet, e.g. in a transport protocol, or associated to other physical properties such as the precise time (and radio channel) of reception of the packet. [Section 3.2.2](#).
- o Replicating these packets into multiple DetNet member flows and, typically, sending them along at least two different paths to the destination(s), e.g. over the explicit routes of
- o Eliminating duplicated packets. This may be done at any step along the path to save network resources further down, in particular if multiple Replication points exist. But the most common case is to perform this operation at the very edge of the DetNet network, preferably in or near the receiver.

This function is a "hitless" version of, e.g., the 1+1 linear protection in [[RFC6372](#)]. That is, instead of switching from one flow

to the other when a failure of a flow is detected, DetNet combines both flows, and performs a packet-by-packet selection of which to discard, based on sequence number.

In the simplest case, this amounts to replicating each packet in a source that has two interfaces, and conveying them through the network, along separate paths, to the similarly dual-homed destinations, that discard the extras. This ensures that one path (with zero congestion loss) remains, even if some intermediate node fails. The sequence numbers can also be used for loss detection and for re-ordering.

Detnet relay nodes in the network can provide replication and elimination facilities at various points in the network, so that multiple failures can be accommodated.

This is shown in the following figure, where the two relay nodes each

replicate (R) the DetNet flow on input, sending the DetNet member flows to both the other relay node and to the end system, and eliminate duplicates (E) on the output interface to the right-hand end system. Any one link in the network can fail, and the Detnet compound flow can still get through. Furthermore, two links can fail, as long as they are in different segments of the network.

Packet replication and elimination

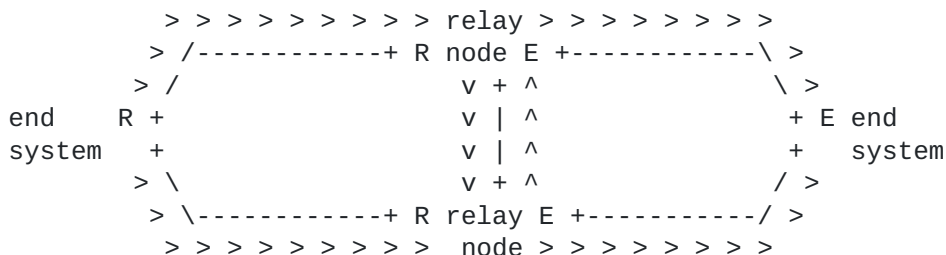

Figure 1

Note that packet replication and elimination does not react to and correct failures; it is entirely passive. Thus, intermittent failures, mistakenly created packet filters, or misrouted data is handled just the same as the equipment failures that are detected handled by typical routing and bridging protocols.

If packet replication and elimination is used over paths providing congestion protection ([Section 3.2.1](#)), and member flows that take different-length paths through the network are combined, a merge point may require extra buffering to equalize the delays over the different paths. This equalization ensures that the resultant compound flow will not exceed its contracted bandwidth even after one or the other of the paths is restored after a failure.

3.3. Secondary goals for DetNet

Many applications require DetNet to provide additional services, including coexistence with other QoS mechanisms [Section 3.3.1](#) and protection against misbehaving transmitters [Section 3.3.2](#).

3.3.1. Coexistence with normal traffic

A DetNet network supports the dedication of a high proportion (e.g. 75%) of the network bandwidth to DetNet flows. But, no matter how much is dedicated for DetNet flows, it is a goal of DetNet to coexist with existing Class of Service schemes (e.g., DiffServ). It is also

important that non-DetNet traffic not disrupt the DetNet flow, of course (see [Section 3.3.2](#) and [Section 6](#)). For these reasons:

- o Bandwidth (transmission opportunities) not utilized by a DetNet flow are available to non-DetNet packets (though not to other DetNet flows).
- o DetNet flows can be shaped or scheduled, in order to ensure that the highest-priority non-DetNet packet also is ensured a worst-case latency (at any given hop).
- o When transmission opportunities for DetNet flows are scheduled in detail, then the algorithm constructing the schedule should leave sufficient opportunities for non-DetNet packets to satisfy the needs of the users of the network. Detailed scheduling can also permit the time-shared use of buffer resources by different

DetNet

flows.

Ideally, the net effect of the presence of DetNet flows in a network on the non-DetNet packets is primarily a reduction in the available bandwidth.

[3.3.2. Fault Mitigation](#)

One key to building robust real-time systems is to reduce the infinite variety of possible failures to a number that can be analyzed with reasonable confidence. DetNet aids in the process by providing filters and policers to detect DetNet packets received on the wrong interface, or at the wrong time, or in too great a volume, and to then take actions such as discarding the offending packet, shutting down the offending DetNet flow, or shutting down the offending interface.

It is also essential that filters and service remarking be employed at the network edge to prevent non-DetNet packets from being mistaken

for DetNet packets, and thus impinging on the resources allocated to DetNet packets.

There exist techniques, at present and/or in various stages of standardization, that can perform these fault mitigation tasks that deliver a high probability that misbehaving systems will have zero impact on well-behaved DetNet flows, except of course, for the receiving interface(s) immediately downstream of the misbehaving device. Examples of such techniques include traffic policing functions (e.g. [\[RFC2475\]](#)) and separating flows into per-flow rate-limited queues.

4. DetNet Architecture

4.1. DetNet stack model

4.1.1. Representative Protocol Stack Model

Figure 2 illustrates a conceptual DetNet data plane layering model. One may compare it to that in [[IEEE802.1CB](#)], Annex C, a work in progress.

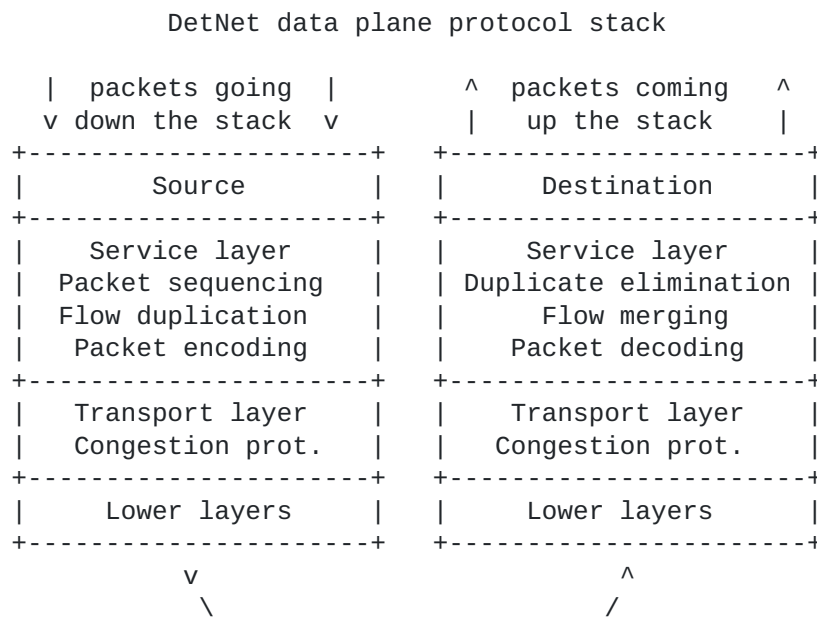

Figure 2

Not all layers are required for any given application, or even for any given network. The layers are, from top to bottom:

Application

Shown as "source" and "destination" in the diagram.

OAM

Operations, Administration, and Maintenance leverages in-

band

and out-of-band signaling that validates whether the service is effectively obtained within QoS constraints. OAM is not shown in Figure 2; it may reside in any number of the

layers.

OAM can involve specific tagging added in the packets for tracing implementation or network configuration errors; traceability enables to find whether a packet is a replica, which relay node performed the replication, and which

segment

was intended for the replica.

Packet sequencing

As part of DetNet service protection, supplies the sequence number for packet replication and elimination ([Section 3.2.4](#)). Peers with Duplicate elimination. This layer is not needed if a higher-layer transport protocol is expected to perform any packet sequencing and duplicate elimination required by the DetNet flow duplication.

Duplicate elimination

As part of the DetNet service layer, based on the sequenced number supplied by its peer, packet sequencing, Duplicate elimination discards any duplicate packets generated by DetNet flow duplication. It can operate on member flows, compound flows, or both. The duplication may also be inferred from other information such as the precise time of reception in a scheduled network. The duplicate elimination layer may also perform resequencing of packets to restore packet order in a flow that was disrupted by the loss of packets on one or another of the multiple paths taken.

Flow duplication

As part of DetNet service protection, replicates packets that belong to a DetNet compound flow into two or more DetNet member flows. Note that this function is separate from packet sequencing. Flow duplication can be an explicit duplication and remarking of packets, or can be performed by, for example, techniques similar to ordinary multicast replication. Peers with DetNet flow merging.

Network flow merging

As part of DetNet service protection, merges DetNet member flows together for packets coming up the stack belonging to a specific DetNet compound flow. Peers with DetNet flow duplication. DetNet flow merging, together with packet sequencing, duplicate elimination, and DetNet flow duplication, performs packet replication and elimination ([Section 3.2.4](#)).

Packet encoding

As part of DetNet service protection, as an alternative to packet sequencing and flow duplication, packet encoding combines the information in multiple DetNet packets, perhaps from different DetNet compound flows, and transmits that information in packets on different DetNet member Flows. Peers with Packet decoding.

Packet decoding

As part of DetNet service protection, as an alternative to flow merging and duplicate elimination, packet decoding takes packets from different DetNet member flows, and computes from those packets the original DetNet packets from the compound flows input to packet encoding. Peers with Packet encoding.

Congestion protection

The DetNet transport layer provides congestion protection. See [Section 4.5](#). The actual queuing and shaping mechanisms are typically provided by underlying subnet layers, but since these can be closely associated with the means of providing paths for DetNet flows (e.g. MPLS LSPs or {VLAN, multicast destination MAC address} pairs), the path and the congestion protection are conflated in this figure.

Note that the packet sequencing and duplication elimination functions at the source and destination ends of a DetNet compound flow may be performed either in the end system or in a DetNet edge node. The reader must not confuse a DetNet edge function with other kinds of edge functions, e.g. an Label Edge Router, although the two functions may be performed together. The DetNet edge function is concerned with sequencing packets belonging to DetNet flows. The LER with encapsulating/decapsulating packets for transport, and is considered part of the network underlying the DetNet transport layer.

4.1.2. DetNet Data Plane Overview

A "Deterministic Network" will be composed of DetNet enabled nodes i.e., End Systems, Edge Nodes, Relay Nodes and collectively deliver DetNet services. DetNet enabled nodes are interconnected via Transit Nodes (i.e., routers) which support DetNet, but are not DetNet service aware. Transit nodes see DetNet nodes as end points. All DetNet enabled nodes are connect to sub-networks, where a point-to-point link is also considered as a simple sub-network. These sub-networks will provide DetNet compatible service for support of DetNet traffic. Examples of sub-networks include IEEE 802.1 TSN and OTN. Of course, multi-layer DetNet systems may also be possible, where one DetNet appears as a sub-network, and provides service to, a higher layer DetNet system. A simple DetNet concept network is shown in Figure 3.

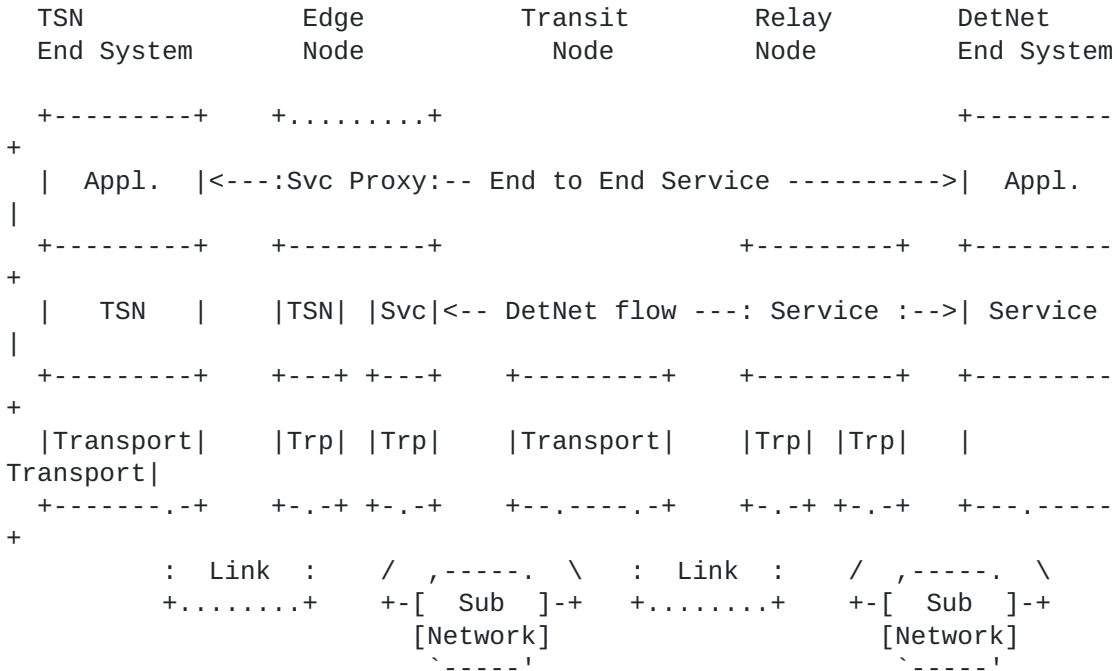

Figure 3: A Simple DetNet Enabled Network

Distinguishing the function of these two DetNet data plane layers, the DetNet service layer and the DetNet transport layer, helps to explore and evaluate various combinations of the data plane solutions

available. This separation of DetNet layers, while helpful, should not be considered as formal requirement. For example, some technologies may violate these strict layers and still be able to deliver a DetNet service.

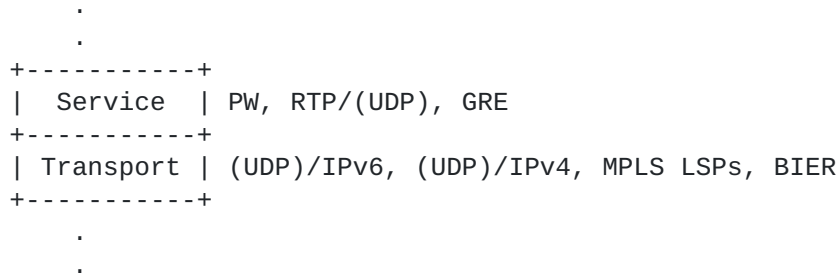

Figure 4: DetNet adaptation to data plane

In some networking scenarios, the end system initially provides a DetNet flow encapsulation, which contains all information needed by DetNet nodes (e.g., Real-time Transport Protocol (RTP) [RFC3550] based DetNet flow transported over a native UDP/IP network or PseudoWire). In other scenarios, the encapsulation formats might differ significantly. As an example, a CPRI "application's" I/Q data

mapped directly to Ethernet frames may have to be transported over an MPLS-based packet switched network (PSN).

There are many valid options to create a data plane solution for DetNet traffic by selecting a technology approach for the DetNet

service layer and also selecting a technology approach for the DetNet transport layer. There are a high number of valid combinations.

One of the most fundamental differences between different potential data plane options is the basic addressing and headers used by DetNet end systems. For example, is the basic service a Layer 2 (e.g., Ethernet) or Layer 3 (i.e., IP) service. This decision impacts how DetNet end systems are addressed, and the basic forwarding logic for the DetNet service layer.

4.1.3. Network reference model

The figure below shows another view of the DetNet service related reference points and main components (Figure 5).

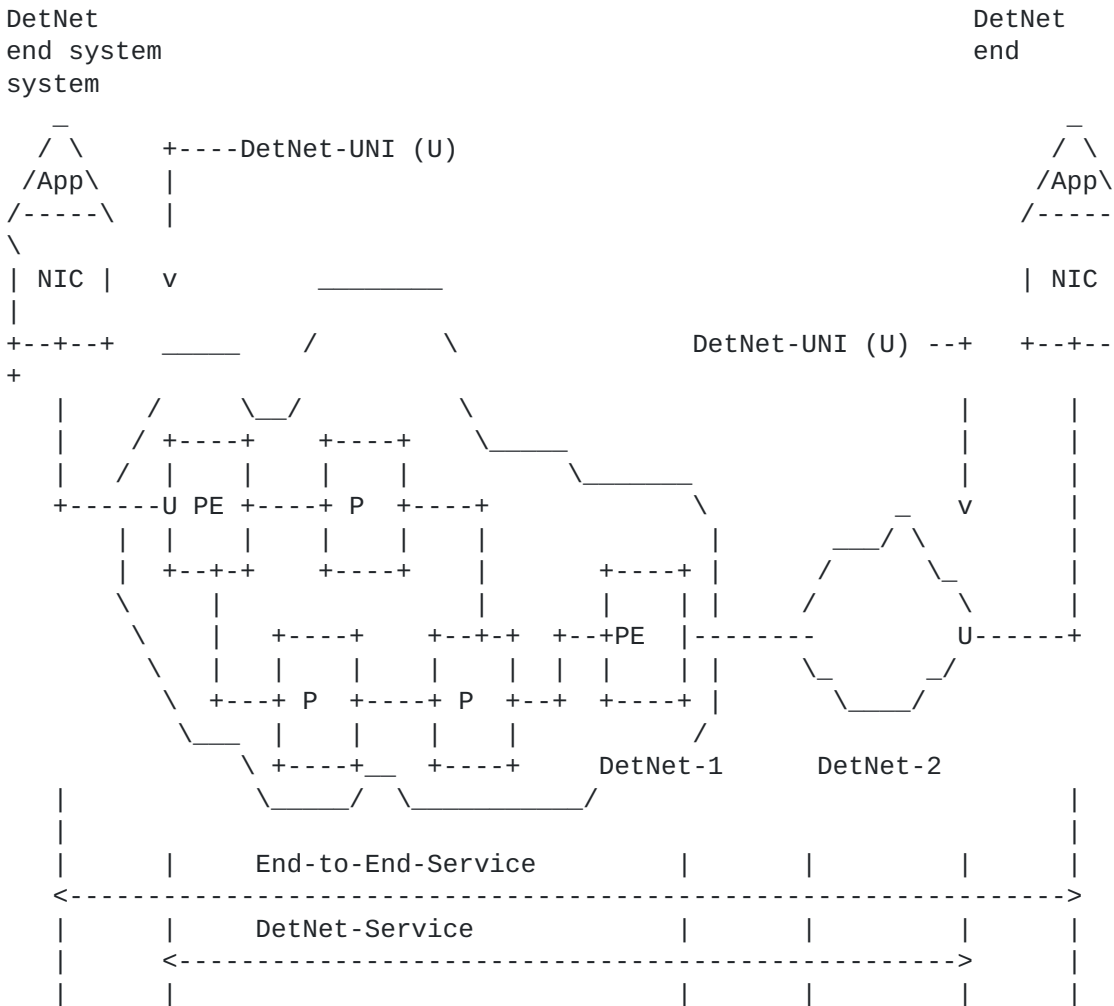

Figure 5: DetNet Service Reference Model (multi-domain)

DetNet-UNIs ("U" in Figure 5) are assumed in this document to be

packet-based reference points and provide connectivity over the packet network. A DetNet-UNI may provide multiple functions, e.g.,

Finn, et al.
18]

Expires December 31, 2017

[Page

it may add networking technology specific encapsulation to the DetNet

flows if necessary; it may provide status of the availability of the connection associated to a reservation; it may provide a synchronization service for the end system; it may carry enough signaling to place the reservation in a network without a controller,

or if the controller only deals with the network but not the end points. Internal reference points of end systems (between the application and the NIC) are more challenging from control perspective and they may have extra requirements (e.g., in-order delivery is expected in end system internal reference points, whereas

it is considered optional over the DetNet-UNI), therefore not covered in this document.

4.2. DetNet systems

4.2.1. End system

The native data flow between the source/destination end systems is referred to as application-flow (App-flow). The traffic characteristics of an App-flow can be CBR (constant bit rate) or VBR (variable bit rate) and can have L1 or L2 or L3 encapsulation (e.g., TDM (time-division multiplexing), Ethernet, IP). These characteristics are considered as input for resource reservation and might be simplified to ensure determinism during transport (e.g., making reservations for the peak rate of VBR traffic, etc.).

An end system may or may not be DetNet transport layer aware or DetNet service layer aware. That is, an end system may or may not contain DetNet specific functionality. End systems with DetNet functionalities may have the same or different transport layer as the

connected DetNet domain. Grouping of end systems are shown in Figure 6.

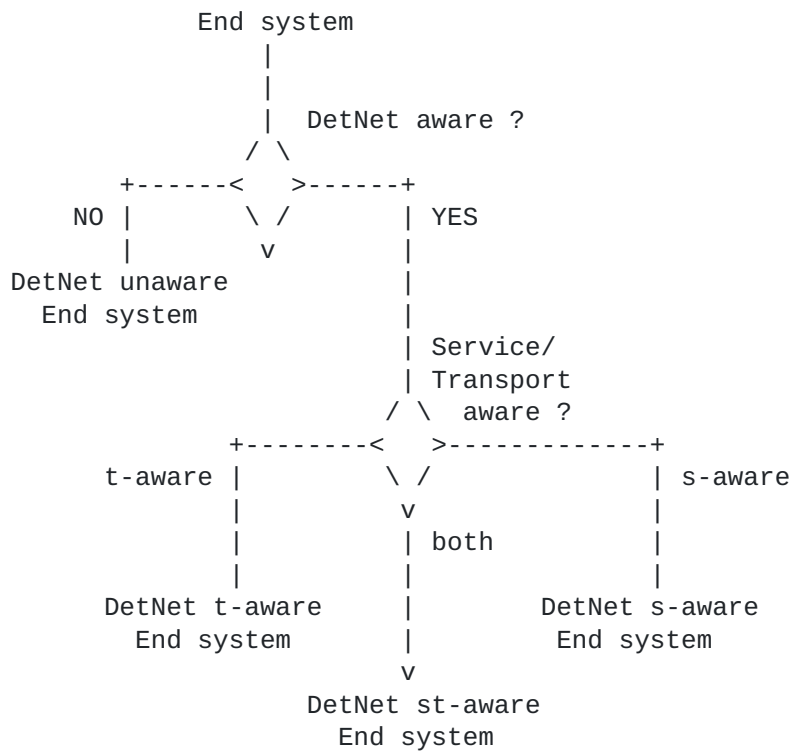

Figure 6: Grouping of end systems

Note some known use cases for end systems:

- o DetNet unaware: The classic case requiring network proxies.
- o DetNet t-aware: An extant TSN system. It knows about some TSN functions (e.g., reservation), but not about replication/elimination.
- o DetNet s-aware: An extant IEC 62439-3 system. It supplies sequence numbers, but doesn't know about zero congestion loss.
- o DetNet st-aware: A full functioning DetNet end station, it has DetNet functionalities and usually the same forwarding paradigm as the connected DetNet domain. It can be treated as an integral part of the DetNet domain .

4.2.2. DetNet edge, relay, and transit nodes

As shown in Figure 3, DetNet edge nodes providing proxy service and DetNet relay nodes providing the DetNet service layer are DetNet-aware, and DetNet transit nodes need only be aware of the DetNet transport layer.

In general, if a DetNet flow passes through one or more DetNet-unaware network node between two DetNet nodes providing the DetNet transport layer for that flow, there is a potential for disruption or failure of the DetNet QoS. A network administrator needs to ensure that the DetNet-unaware network nodes are configured to minimize the chances of packet loss and delay, and provision enough extra buffer space in the DetNet transit node following the DetNet-unaware network nodes to absorb the induced latency variations.

4.3. DetNet flows

4.3.1. DetNet flow types

A DetNet flow can have different formats during while it is transported between the peer end systems. Therefore, the following possible types / formats of a DetNet flow are distinguished in this document:

- o App-flow: native format of a DetNet flow. It does not contain any DetNet related attributes.
- o DetNet-t-flow: specific format of a DetNet flow. Only requires the congestion / latency features provided by the Detnet transport layer.
- o DetNet-s-flow: specific format of a DetNet flow. Only requires the replication/elimination feature ensured by the DetNet service layer.
- o DetNet-st-flow: specific format of a DetNet flow. It requires both DetNet service layer and DetNet transport layer functions during forwarding.

4.3.2. Source guarantees

For the purposes of congestion protection, DetNet flows can be synchronous or asynchronous. In synchronous DetNet flows, at least the intermediate nodes (and possibly the end systems) are closely time synchronized, typically to better than 1 microsecond. By transmitting packets from different DetNet flows or classes of DetNet flows at different times, using repeating schedules synchronized among the intermediate nodes, resources such as buffers and link bandwidth can be shared over the time domain among different DetNet flows. There is a tradeoff among techniques for synchronous DetNet flows between the burden of fine-grained scheduling and the benefit of reducing the required resources, especially buffer space.

In contrast, asynchronous DetNet flows are not coordinated with a fine-grained schedule, so relay and end systems must assume worst-case interference among DetNet flows contending for buffer resources.

Asynchronous DetNet flows are characterized by:

- o A maximum packet size;
- o An observation interval; and
- o A maximum number of transmissions during that observation interval.

These parameters, together with knowledge of the protocol stack used (and thus the size of the various headers added to a packet), limit the number of bit times per observation interval that the DetNet flow can occupy the physical medium.

The source promises that these limits will not be exceeded. If the source transmits less data than this limit allows, the unused resources such as link bandwidth can be made available by the system to non-DetNet packets. However, making those resources available to DetNet packets in other DetNet flows would serve no purpose. Those other DetNet flows have their own dedicated resources, on the assumption that all DetNet flows can use all of their resources over a long period of time.

Note that there is no provision in DetNet for throttling DetNet flows (reducing the transmission rate via feedback); the assumption is that

a DetNet flow, to be useful, must be delivered in its entirety.

That

is, while any useful application is written to expect a certain number of lost packets, the real-time applications of interest to DetNet demand that the loss of data due to the network is extraordinarily infrequent.

Although DetNet strives to minimize the changes required of an application to allow it to shift from a special-purpose digital network to an Internet Protocol network, one fundamental shift in the

behavior of network applications is impossible to avoid: the reservation of resources before the application starts. In the first

place, a network cannot deliver finite latency and practically zero packet loss to an arbitrarily high offered load. Secondly, achieving

practically zero packet loss for unthrottled (though bandwidth limited) DetNet flows means that bridges and routers have to dedicate

buffer resources to specific DetNet flows or to classes of DetNet flows. The requirements of each reservation have to be translated into the parameters that control each system's queuing, shaping, and scheduling functions and delivered to the hosts, bridges, and routers.

4.3.3. Incomplete Networks

The presence in the network of transit nodes or subnets that are not fully capable of offering DetNet services complicates the ability of the intermediate nodes and/or controller to allocate resources, as extra buffering, and thus extra latency, must be allocated at points downstream from the non-DetNet intermediate node for a DetNet flow.

4.4. Traffic Engineering for DetNet

Traffic Engineering Architecture and Signaling (TEAS) [[TEAS](#)] defines traffic-engineering architectures for generic applicability across packet and non-packet networks. From TEAS perspective, Traffic Engineering (TE) refers to techniques that enable operators to control how specific traffic flows are treated within their networks.

Because of its very nature of establishing explicit optimized paths, Deterministic Networking can be seen as a new, specialized branch of Traffic Engineering, and inherits its architecture with a separation into planes.

The Deterministic Networking architecture is thus composed of three planes, a (User) Application Plane, a Controller Plane, and a Network Plane, which echoes that of Figure 1 of Software-Defined Networking (SDN): Layers and Architecture Terminology [[RFC7426](#)].:

4.4.1. The Application Plane

Per [[RFC7426](#)], the Application Plane includes both applications and services. In particular, the Application Plane incorporates the User

Agent, a specialized application that interacts with the end user / operator and performs requests for Deterministic Networking services via an abstract Flow Management Entity, (FME) which may or may not be collocated with (one of) the end systems.

At the Application Plane, a management interface enables the negotiation of flows between end systems. An abstraction of the flow

called a Traffic Specification (TSpec) provides the representation. This abstraction is used to place a reservation over the (Northbound)

Service Interface and within the Application plane. It is associated

with an abstraction of location, such as IP addresses and DNS names, to identify the end systems and eventually specify intermediate nodes.

4.4.2. The Controller Plane

The Controller Plane corresponds to the aggregation of the Control and Management Planes in [RFC7426], though Common Control and Measurement Plane (CCAMP) [CCAMP] makes an additional distinction between management and measurement. When the logical separation of the Control, Measurement and other Management entities is not relevant, the term Controller Plane is used for simplicity to represent them all, and the term controller refers to any device operating in that plane, whether is it a Path Computation entity or

a

Network Management entity (NME). The Path Computation Element (PCE) [PCE] is a core element of a controller, in charge of computing Deterministic paths to be applied in the Network Plane.

A (Northbound) Service Interface enables applications in the Application Plane to communicate with the entities in the Controller Plane.

One or more PCE(s) collaborate to implement the requests from the FME

as Per-Flow Per-Hop Behaviors installed in the intermediate nodes for

each individual flow. The PCEs place each flow along a deterministic

sequence of intermediate nodes so as to respect per-flow constraints such as security and latency, and optimize the overall result for metrics such as an abstract aggregated cost. The deterministic sequence can typically be more complex than a direct sequence and include redundancy path, with one or more packet replication and elimination points.

4.4.3. The Network Plane

The Network Plane represents the network devices and protocols as a whole, regardless of the Layer at which the network devices operate. It includes Forwarding Plane (data plane), Application, and Operational Plane (control plane) aspects.

The network Plane comprises the Network Interface Cards (NIC) in the end systems, which are typically IP hosts, and intermediate nodes, which are typically IP routers and switches. Network-to-Network Interfaces such as used for Traffic Engineering path reservation in [RFC5921], as well as User-to-Network Interfaces (UNI) such as provided by the Local Management Interface (LMI) between network and end systems, are both part of the Network Plane, both in the control plane and the data plane.

A Southbound (Network) Interface enables the entities in the Controller Plane to communicate with devices in the Network Plane. This interface leverages and extends TEAS to describe the physical topology and resources in the Network Plane.

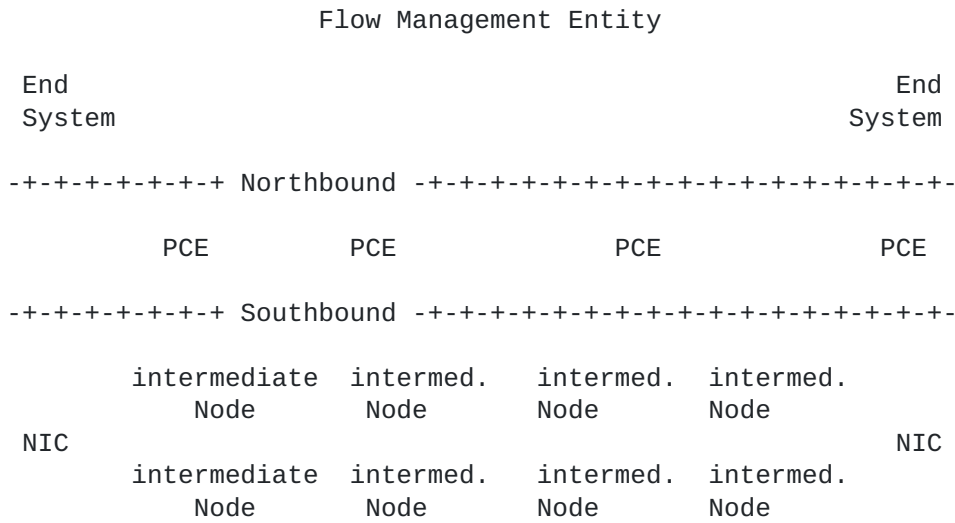

Figure 7

The intermediate nodes (and eventually the end systems NIC) expose their capabilities and physical resources to the controller (the PCE), and update the PCE with their dynamic perception of the topology, across the Southbound Interface. In return, the PCE(s) set the per-flow paths up, providing a Flow Characterization that is more tightly coupled to the intermediate node Operation than a TSpec.

At the Network plane, intermediate nodes may exchange information regarding the state of the paths, between adjacent systems and eventually with the end systems, and forward packets within constraints associated to each flow, or, when unable to do so, perform a last resort operation such as drop or declassify.

This specification focuses on the Southbound interface and the operation of the Network Plane.

4.5. Queuing, Shaping, Scheduling, and Preemption

DetNet achieves congestion protection and bounded delivery latency by reserving bandwidth and buffer resources at every hop along the path of the DetNet flow. The reservation itself is not sufficient, however. Implementors and users of a number of proprietary and standard real-time networks have found that standards for specific data plane techniques are required to enable these assurances to be made in a multi-vendor network. The fundamental reason is that latency variation in one system results in the need for extra buffer space in the next-hop system(s), which in turn, increases the worst-case per-hop latency.

Standard queuing and transmission selection algorithms allow a central controller to compute the latency contribution of each transit node to the end-to-end latency, to compute the amount of buffer space required in each transit node for each incremental DetNet flow, and most importantly, to translate from a flow specification to a set of values for the managed objects that control

each relay or end system. The IEEE 802 has specified (and is specifying) a set of queuing, shaping, and scheduling algorithms that

enable each transit node (bridge or router), and/or a central controller, to compute these values. These algorithms include:

- o A credit-based shaper [[IEEE802.1Q-2014](#)] Clause 34.
- o Time-gated queues governed by a rotating time schedule, synchronized among all transit nodes [[IEEE802.1Qbv](#)].
- o Synchronized double (or triple) buffers driven by synchronized time ticks. [[IEEE802.1Qch](#)].
- o Pre-emption of an Ethernet packet in transmission by a packet with a more stringent latency requirement, followed by the resumption of the preempted packet [[IEEE802.1Qbu](#)], [[IEEE802.3br](#)].

While these techniques are currently embedded in Ethernet and bridging standards, we can note that they are all, except perhaps for packet preemption, equally applicable to other media than Ethernet, and to routers as well as bridges.

4.6. Service instance

[Note: Service instance represents all the functions required on a node to allow the end-to-end service between the UNIs.]

The DetNet network reference model is shown in Figure 8 for a DetNet-

Service scenario (i.e. between two DetNet-UNIs). In this figure, the end systems ("A" and "B") are connected directly to the edge nodes of

the IP/MPLS network ("PE1" and "PE2"). End-systems participating DetNet communication may require connectivity before setting up an App-flow that requires the DetNet service. Such a connectivity related service instance and the one dedicated for DetNet service share the same access. Packets belonging to a DetNet flow are selected by a filter configured on the access ("F1" and "F2"). As a result, data flow specific access ("access-A + F1" and "access-B + F2") are terminated in the flow specific service instance ("SI-1" and

"SI-2"). A tunnel is used to provide connectivity between the service instances.

Finn, et al.
26]

Expires December 31, 2017

[Page

4.7.1. Exporting flow identification

An interesting feature of DetNet, and one that invites implementations that can be accused of "layering violations", is the need for lower layers to be aware of specific flows at higher layers,

in order to provide specific queuing and shaping services for specific flows. For example:

- o A non-IP, strictly L2 source end system X may be sending multiple flows to the same L2 destination end system Y. Those flows may include DetNet flows with different QoS requirements, and may include non-DetNet flows.
- o A router may be sending any number of flows to another router. Again, those flows may include DetNet flows with different QoS requirements, and may include non-DetNet flows.
- o Two routers may be separated by bridges. For these bridges to perform any required per-flow queuing and shaping, they must be able to identify the individual flows.
- o A Label Edge Router (LERs) may have a Label Switched Path (LSP) set up for handling traffic destined for a particular IP address carrying only non-DetNet flows. If a DetNet flow to that same address is requested, a separate LSP may be needed, in order that all of the Label Switch Routers (LSRs) along the path to the destination give that flow special queuing and shaping.

The need for a lower-level DetNet node to be aware of individual higher-layer flows is not unique to DetNet. But, given the endless complexity of layering and relayering over tunnels that is available to network designers, DetNet needs to provide a model for flow identification that is at least somewhat better than packet inspection. That is not to say that packet inspection to layer 4 or 5 addresses will not be used, or the capability standardized; but, there are alternatives.

A DetNet relay node can connect DetNet flows on different paths using different flow identification methods. For example:

- o A single unicast DetNet flow passing from router A through a bridged network to router B may be assigned a {VLAN, multicast destination MAC address} pair that is unique within that bridged network. The bridges can then identify the flow without accessing higher-layer headers. Of course, the receiving router must recognize and accept that multicast MAC address.
- o A DetNet flow passing from LSR A to LSR B may be assigned a different label than that used for other flows to the same IP destination.

In any of the above cases, it is possible that an existing DetNet flow can be used as a carrier for multiple DetNet sub-flows. (Not to

be confused with DetNet compound vs. member flows.) Of course, this requires that the aggregate DetNet flow be provisioned properly to carry the sub-flows.

Thus, rather than packet inspection, there is the option to export higher-layer information to the lower layer. The requirement to support one or the other method for flow identification (or both) is the essential complexity that DetNet brings to existing control plane models.

4.7.2. Flow attribute mapping between layers

Transport of DetNet flows over multiple technology domains may require that lower layers are aware of specific flows of higher layers. Such an "exporting of flow identification" is needed each time when the forwarding paradigm is changed on the transport path (e.g., two LSRs are interconnected by a L2 bridged domain, etc.). The three main forwarding methods considered for deterministic networking are:

- o IP routing
- o MPLS label switching
- o Ethernet bridging

Note: at the time of this publication, the exact format of flow identification is still WIP.

[Note: Seq-num attribute may require a similar functionality at technology border nodes.]

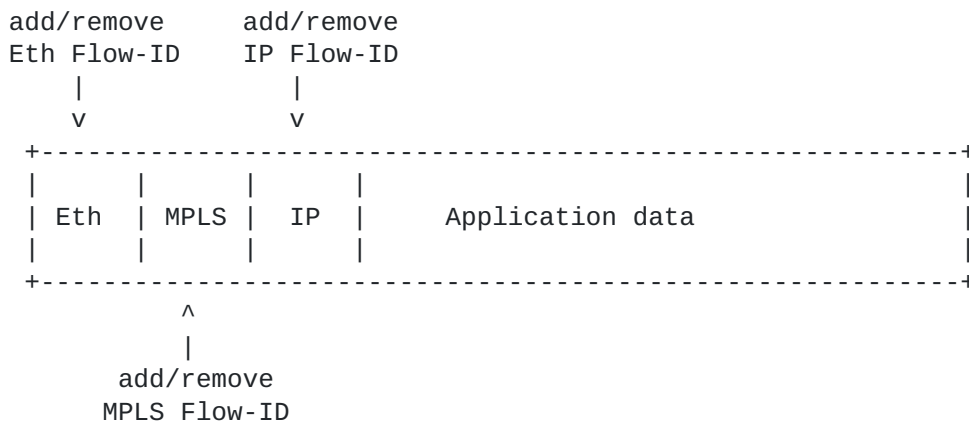

Figure 9: Packet with multiple Flow-IDs

End system "IP-A" uses the original App-flow specific ID ("L3-ID"), but as it is connected to an Ethernet domain it has to push an Ethernet-domain specific flow-ID ("VID + multicast MAC address", referred as "ETH-ID") before sending the packet to "ETH-1" node. Ethernet switch "ETH-1" can recognize the data flow based on the "ETH-ID" and it does forwarding toward "ETH-2". "ETH-2" switches the packet toward the IP router. "IP-1" must be configured to receive the Ethernet Flow-ID specific multicast stream, but (as it is an L3 node) it decodes the data flow ID based on the "L3-ID" fields of the received packet.

Figure 11 shows a scenario where MPLS domain nodes ("PE-n" and "P-m") are connected via two Ethernet switches ("ETH-n").

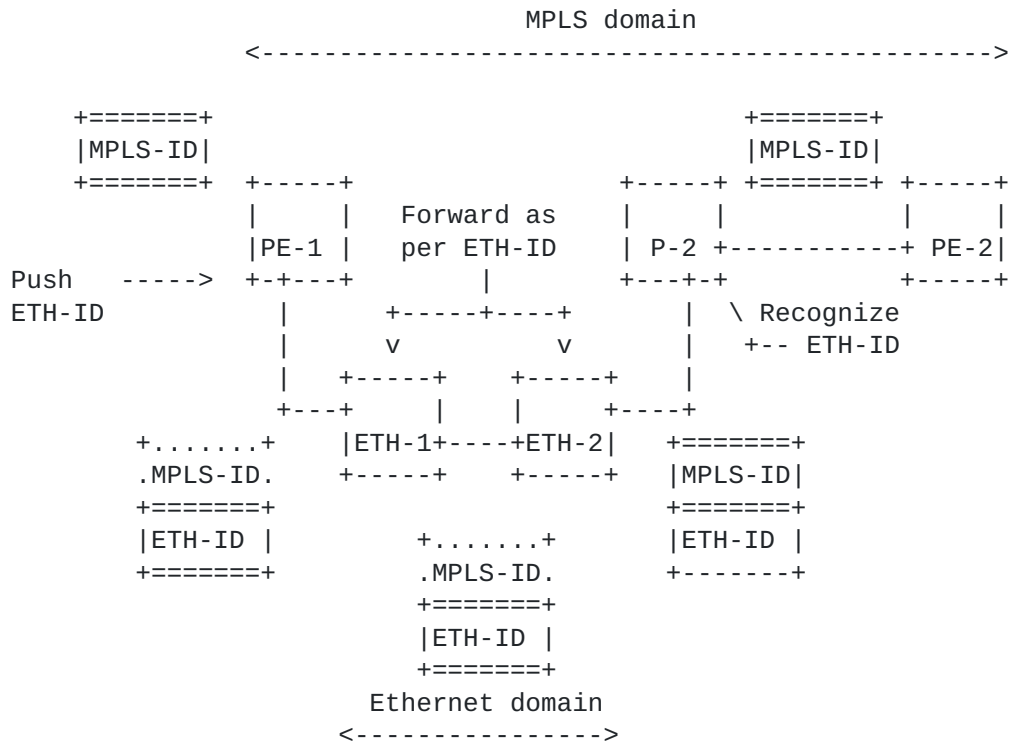

Figure 11: MPLS nodes interconnected by an Ethernet domain

"PE-1" uses the MPLS specific ID ("MPLS-ID"), but as it is connected to an Ethernet domain it has to push an Ethernet-domain specific flow-ID ("VID + multicast MAC address", referred as "ETH-ID") before sending the packet to "ETH-1". Ethernet switch "ETH-1" can recognize the data flow based on the "ETH-ID" and it does forwarding toward "ETH-2". "ETH-2" switches the packet toward the MPLS node ("P-2"). "P-2" must be configured to receive the Ethernet Flow-ID specific

multicast stream, but (as it is an MPLS node) it decodes the data flow ID based on the "MPLS-ID" fields of the received packet.

4.8. Advertising resources, capabilities and adjacencies

There are three classes of information that a central controller or decentralized control plane needs to know that can only be obtained from the end systems and/or transit nodes in the network. When using

a peer-to-peer control plane, some of this information may be required by a system's neighbors in the network.

- o Details of the system's capabilities that are required in order to accurately allocate that system's resources, as well as other systems' resources. This includes, for example, which specific queuing and shaping algorithms are implemented ([Section 4.5](#)), the number of buffers dedicated for DetNet allocation, and the worst-case forwarding delay.
- o The dynamic state of an end or transit node's DetNet resources.
- o The identity of the system's neighbors, and the characteristics of the link(s) between the systems, including the length (in nanoseconds) of the link(s).

4.9. Provisioning model

4.9.1. Centralized Path Computation and Installation

A centralized routing model, such as provided with a PCE ([RFC 4655](#) [[RFC4655](#)]), enables global and per-flow optimizations. (See [Section 4.4.](#)) The model is attractive but a number of issues are left to be solved. In particular:

- o Whether and how the path computation can be installed by 1) an end device or 2) a Network Management entity,
- o And how the path is set up, either by installing state at each hop with a direct interaction between the forwarding device and the PCE, or along a path by injecting a source-routed request at one end of the path.

4.9.2. Distributed Path Setup

Significant work on distributed path setup can be leveraged from MPLS

Traffic Engineering, in both its GMPLS and non-GMPLS forms. The protocols within scope are Resource ReSerVation Protocol [[RFC3209](#)]

[\[RFC3473\]](#) (RSVP-TE), OSPF-TE [\[RFC4203\]](#) [\[RFC5392\]](#) and ISIS-TE [\[RFC5307\]](#)

Finn, et al.
32]

Expires December 31, 2017

[Page

[[RFC5316](#)]. These should be viewed as starting points as there are feature specific extensions defined that may be applicable to DetNet.

In a Layer-2 only environment, or as part of a layered approach to a mixed environment, IEEE 802.1 also has work, either completed or in progress. [[IEEE802.1Q-2014](#)] Clause 35 describes SRP, a peer-to-peer protocol for Layer-2 roughly analogous to RSVP [[RFC2205](#)]. [[IEEE802.1Qca](#)] defines how ISIS can provide multiple disjoint paths or distribution trees. Also in progress is [[IEEE802.1Qcc](#)], which expands the capabilities of SRP.

The integration/interaction of the DetNet control layer with an underlying IEEE 802.1 sub-network control layer will need to be defined.

4.10. Scaling to larger networks

Reservations for individual DetNet flows require considerable state information in each transit node, especially when adequate fault mitigation ([Section 3.3.2](#)) is required. The DetNet data plane, in order to support larger numbers of DetNet flows, must support the aggregation of DetNet flows into tunnels, which themselves can be viewed by the transit nodes' data planes largely as individual DetNet flows. Without such aggregation, the per-relay system may limit the scale of DetNet networks.

4.11. Connected islands vs. networks

Given that users have deployed examples of the IEEE 802.1 TSN TG standards, which provide capabilities similar to DetNet, it is obvious to ask whether the IETF DetNet effort can be limited to providing Layer-2 connections (VPNs) between islands of bridged TSN networks. While this capability is certainly useful to some applications, and must not be precluded by DetNet, tunneling alone is not a sufficient goal for the DetNet WG. As shown in the Deterministic Networking Use Cases draft [[I-D.ietf-detnet-use-cases](#)], there are already deployments of Layer-2 TSN networks that are encountering the well-known problems of over-large broadcast domains. Routed solutions, and combinations routed/bridged solutions, are both required.

4.12. Compatibility with Layer-2

Standards providing similar capabilities for bridged networks (only) have been and are being generated in the IEEE 802 LAN/MAN Standards Committee. The present architecture describes an abstract model

that

can be applicable both at Layer-2 and Layer-3, and over links not defined by IEEE 802. It is the intention of the authors (and

Finn, et al.
33]

Expires December 31, 2017

[Page

hopefully, as this draft progresses, of the DetNet Working Group) that IETF and IEEE 802 will coordinate their work, via the participation of common individuals, liaisons, and other means, to maximize the compatibility of their outputs.

DetNet enabled end systems and intermediate nodes can be interconnected by sub-networks, i.e., Layer-2 technologies. These sub-networks will provide DetNet compatible service for support of DetNet traffic. Examples of sub-networks include 802.1TSN and a point-to-point OTN link. Of course, multi-layer DetNet systems may be possible too, where one DetNet appears as a sub-network, and provides service to, a higher layer DetNet system.

5. Open Questions

There are a number of architectural questions that will have to be resolved before this document can be submitted for publication. Aside from the obvious fact that this present draft is subject to change, there are specific questions to which the authors wish to direct the readers' attention.

5.1. Flat vs. hierarchical control

Boxes that are solely routers or solely bridges are rare in today's market. In a multi-tenant data center, multiple users' virtual Layer-2/Layer-3 topologies exist simultaneously, implemented on a network whose physical topology bears only accidental resemblance to the virtual topologies.

While the forwarding topology (the bridges and routers) are an important consideration for a DetNet Flow Management Entity ([Section 4.4.1](#)), so is the purely physical topology. Ultimately, the model used by the management entities is based on boxes, queues, and links. The authors hope that the work of the TEAS WG will help to clarify exactly what model parameters need to be traded between the intermediate nodes and the controller(s).

5.2. Peer-to-peer reservation protocol

As described in [Section 4.9.2](#), the DetNet WG needs to decide whether to support a peer-to-peer protocol for a source and a destination to reserve resources for a DetNet stream. Assuming that enabling the involvement of the source and/or destination is desirable (see Deterministic Networking Use Cases [[I-D.ietf-detnet-use-cases](#)]), it remains to decide whether the DetNet WG will make it possible to deploy at least some DetNet capabilities in a network using only a peer-to-peer protocol, without a central controller.

(Note that a UNI (see [Section 4.4.3](#)) between an end system and a DetNet edge node, for sources and/or listeners to request DetNet services, can be either the first hop of a per-to-peer reservation protocol, or can be deflected by the DetNet edge node to a central controller for resolution. Similarly, a decision by a central controller can be effected by the controller instructing the end system or DetNet edge node to initiate a per-to-peer protocol activity.)

5.3. Wireless media interactions

Deterministic Networking Use Cases [[I-D.ietf-detnet-use-cases](#)] illustrates cases where wireless media are needed in a DetNet network. Some wireless media in general use, such as IEEE 802.11 [[IEEE802.1Q-2014](#)], have significantly higher packet loss rates than typical wired media, such as Ethernet [[IEEE802.3-2012](#)]. IEEE 802.11 includes support for such features as MAC-layer acknowledgements and retransmissions.

The techniques described in [Section 3](#) are likely to improve the ability of a mixed wired/wireless network to offer the DetNet QoS features. The interaction of these techniques with the features of specific wireless media, although they may be significant, cannot be addressed in this document. It remains to be decided to what extent the DetNet WG will address them, and to what extent other WGs, e.g. 6TiSCH, will do so.

5.4. Packet encoding for service protection

There are methods for using multiple paths to provide service protection that involve encoding the information in a packet belonging to a DetNet flow into multiple transmission units, typically combining information from multiple packets into any given transmission unit. Such techniques may be applicable for use as a DetNet service protection technique, assuming that the DetNet users' needs for timeliness of delivery and freedom from interference with misbehaving DetNet flows can be met.

No specific mechanisms are defined here, at this time. This section will either be enhanced or removed. Contributions are invited.

6. Security Considerations

Security in the context of Deterministic Networking has an added dimension; the time of delivery of a packet can be just as important as the contents of the packet, itself. A man-in-the-middle attack, for example, can impose, and then systematically adjust, additional delays into a link, and thus disrupt or subvert a real-time

application without having to crack any encryption methods employed. See [[RFC7384](#)] for an exploration of this issue in a related context.

Furthermore, in a control system where millions of dollars of equipment, or even human lives, can be lost if the DetNet QoS is not delivered, one must consider not only simple equipment failures, where the box or wire instantly becomes perfectly silent, but bizarre errors such as can be caused by software failures. Because there is essential no limit to the kinds of failures that can occur, protecting against realistic equipment failures is indistinguishable, in most cases, from protecting against malicious behavior, whether accidental or intentional. See also [Section 3.3.2](#).

Security must cover:

- o the protection of the signaling protocol
- o the authentication and authorization of the controlling systems
- o the identification and shaping of the DetNet flows

7. Privacy Considerations

DetNet provides a Quality of Service (QoS), and as such, does not directly raise any new privacy considerations.

However, the requirement for every (or almost every) node along the path of a DetNet flow to identify DetNet flows may present an additional attack surface for privacy, should the DetNet paradigm be found useful in broader environments.

8. IANA Considerations

This document does not require an action from IANA.

9. Acknowledgements

The authors wish to thank Jouni Korhonen, Erik Nordmark, George Swallow, Rudy Klecka, Anca Zamfir, David Black, Thomas Watteyne, Shitanshu Shah, Craig Gunther, Rodney Cummings, Balazs Varga, Wilfried Steiner, Marcel Kiessling, Karl Weber, Janos Farkas, Ethan Grossman, Pat Thaler, Lou Berger, and especially Michael Johas Teener, for their various contribution with this work.

10. Access to IEEE 802.1 documents

To access password protected IEEE 802.1 drafts, see the IETF IEEE 802.1 information page at <https://www.ietf.org/proceedings/52/slides/bridge-0/tsld003.htm>.

11. Informative References

- [AVnu] <http://www.avnu.org/>, "The AVnu Alliance tests and certifies devices for interoperability, providing a simple and reliable networking solution for AV network implementation based on the Audio Video Bridging (AVB) standards."
- [CCAMP] IETF, "Common Control and Measurement Plane", <<https://datatracker.ietf.org/doc/charter-ietf-ccamp/>>.
- [HART] www.hartcomm.org, "Highway Addressable Remote Transducer, a group of specifications for industrial process and control devices administered by the HART Foundation".
- [HSR-PRP] IEC, "High availability seamless redundancy (HSR) is a further development of the PRP approach, although HSR functions primarily as a protocol for creating media redundancy while PRP, as described in the previous section, creates network redundancy. PRP and HSR are both described in the IEC 62439 3 standard.", <<http://webstore.iec.ch/webstore/webstore.nsf/artnum/046615!opendocument>>.
- [I-D.dt-detnet-dp-alt] Korhonen, J., Farkas, J., Mirsky, G., Thubert, P., Zhuangyan, Z., and L. Berger, "DetNet Data Plane Protocol and Solution Alternatives", [draft-dt-detnet-dp-alt-04](#) (work in progress), September 2016.
- [I-D.ietf-6tisch-architecture] Thubert, P., "An Architecture for IPv6 over the TSCH mode of IEEE 802.15.4", [draft-ietf-6tisch-architecture-11](#) (work in progress), January 2017.
- [I-D.ietf-6tisch-tsch] Watteyne, T., Palattella, M., and L. Grieco, "Using IEEE802.15.4e TSCH in an IoT context: Overview, Problem Statement and Goals", [draft-ietf-6tisch-tsch-06](#) (work in progress), March 2015.

[I-D.ietf-detnet-problem-statement]

Problem Finn, N. and P. Thubert, "Deterministic Networking Statement", [draft-ietf-detnet-problem-statement-01](#) (work in progress), September 2016.

[I-D.ietf-detnet-use-cases]

Vilajosana, Grossman, E., Gunther, C., Thubert, P., Wetterwald, P., Raymond, J., Korhonen, J., Kaneko, Y., Das, S., Zha, Y., Varga, B., Farkas, J., Goetz, F., Schmitt, J., X., Mahmoodi, T., Spirou, S., and P. Vizarreta, "Deterministic Networking Use Cases", [draft-ietf-detnet-use-cases-12](#) (work in progress), April 2017.

[I-D.ietf-roll-rpl-industrial-applicability]

Phinney, T., Thubert, P., and R. Assimiti, "RPL applicability in industrial networks", [draft-ietf-roll-rpl-industrial-applicability-02](#) (work in progress), October 2013.

[I-D.svshah-tsvwg-deterministic-forwarding]

Shah, S. and P. Thubert, "Deterministic Forwarding PHB", [draft-svshah-tsvwg-deterministic-forwarding-04](#) (work in progress), August 2015.

[I-D.varga-detnet-service-model]

Varga, B. and J. Farkas, "DetNet Service Model", [draft-varga-detnet-service-model-02](#) (work in progress), May 2017.

[IEEE802.11-2012]

IEEE, "Wireless LAN Medium Access Control (MAC) and Physical Layer (PHY) Specifications", 2012, <<http://standards.ieee.org/getieee802/download/802.11-2012.pdf>>.

[IEEE802.1AS-2011]

IEEE, "Timing and Synchronizations (IEEE 802.1AS-2011)", 2011, <<http://standards.ieee.org/getIEEE802/download/802.1AS-2011.pdf>>.

[IEEE802.1BA-2011]

IEEE, "AVB (Audio Video Bridging) Systems (IEEE 802.1BA-2011)", 2011, <<http://standards.ieee.org/getIEEE802/download/802.1BA-2011.pdf>>.

[IEEE802.1CB]

IEEE, "Frame Replication and Elimination for Reliability (IEEE Draft P802.1CB)", 2016,
<<http://www.ieee802.org/1/files/private/cb-drafts/>>.

[IEEE802.1Q-2014]

IEEE, "MAC Bridges and VLANs (IEEE 802.1Q-2014", 2014,
<<http://standards.ieee.org/getieee802/download/802-1Q-2014.pdf>>.

[IEEE802.1Qbu]

IEEE, "Frame Preemption", 2016,
<<http://www.ieee802.org/1/files/private/bu-drafts/>>.

[IEEE802.1Qbv]

IEEE, "Enhancements for Scheduled Traffic", 2016,
<<http://www.ieee802.org/1/files/private/bv-drafts/>>.

[IEEE802.1Qca]

IEEE 802.1, "IEEE 802.1Qca Bridges and Bridged Networks - Amendment 24: Path Control and Reservation", IEEE P802.1Qca/D2.1 P802.1Qca, June 2015,
<<https://standards.ieee.org/findstds/standard/802.1Qca-2015.html>>.

[IEEE802.1Qcc]

IEEE, "Stream Reservation Protocol (SRP) Enhancements and Performance Improvements", 2016,
<<http://www.ieee802.org/1/files/private/cc-drafts/>>.

[IEEE802.1Qch]

IEEE, "Cyclic Queuing and Forwarding", 2016,
<<http://www.ieee802.org/1/files/private/ch-drafts/>>.

[IEEE802.1TSNTG]

IEEE Standards Association, "IEEE 802.1 Time-Sensitive Networks Task Group", 2013,
<<http://www.IEEE802.org/1/pages/avbridges.html>>.

[IEEE802.3-2012]

IEEE, "IEEE Standard for Ethernet", 2012,
<<http://standards.ieee.org/getieee802/download/802.3-2012.pdf>>.

[IEEE802.3br]

IEEE, "Interspersed Express Traffic", 2016,
<<http://www.ieee802.org/3/br/>>.

[IEEE802154]

IEEE Standard for Information Technology, "IEEE 802.15.4, Part. 15.4: Wireless Medium Access Control (MAC) and Physical Layer (PHY) Specifications for Low-Rate Wireless Personal Area Networks", June 2011.

[IEEE802154e]

IEEE Standard for Information Technology, "IEEE 802.15.4e, Part. 15.4: Low-Rate Wireless Personal Area Networks (LR-WPANS) Amendment 1: MAC sublayer", April 2012.

[ISA100.11a]

ISA/IEC, "ISA100.11a, Wireless Systems for Automation, also IEC 62734", 2011, <[http://www.isa100wci.org/en-US/Documents/PDF/3405-ISA100-WirelessSystems-Future-broch-
WEB-ETSI.aspx](http://www.isa100wci.org/en-US/Documents/PDF/3405-ISA100-WirelessSystems-Future-broch-
WEB-ETSI.aspx)>.

[ISA95]

ANSI/ISA, "Enterprise-Control System Integration Part 1: Models and Terminology", 2000, <<https://www.isa.org/isa95/>>.

[ODVA]

<http://www.odva.org/>, "The organization that supports network technologies built on the Common Industrial Protocol (CIP) including EtherNet/IP."

[PCE]

IETF, "Path Computation Element", <<https://datatracker.ietf.org/doc/charter-ietf-pce/>>.

[Profinet]

<http://us.profinet.com/technology/profinet/>, "PROFINET is a standard for industrial networking in automation.", <<http://us.profinet.com/technology/profinet/>>.

[RFC2205]
S.

Braden, R., Ed., Zhang, L., Berson, S., Herzog, S., and Jamin, "Resource ReSerVation Protocol (RSVP) -- Version 1 Functional Specification", [RFC 2205](#), DOI 10.17487/

RFC2205,

September 1997, <<http://www.rfc-editor.org/info/rfc2205>>.

[RFC2475]

Blake, S., Black, D., Carlson, M., Davies, E., Wang, Z., and W. Weiss, "An Architecture for Differentiated Services", [RFC 2475](#), DOI 10.17487/RFC2475, December 1998, <<http://www.rfc-editor.org/info/rfc2475>>.

[RFC3209]

Awduche, D., Berger, L., Gan, D., Li, T., Srinivasan, V., and G. Swallow, "RSVP-TE: Extensions to RSVP for LSP Tunnels", [RFC 3209](#), DOI 10.17487/RFC3209, December 2001, <<http://www.rfc-editor.org/info/rfc3209>>.

- [RFC3473] Berger, L., Ed., "Generalized Multi-Protocol Label Switching (GMPLS) Signaling Resource ReserVation Protocol-
Traffic Engineering (RSVP-TE) Extensions", [RFC 3473](#), DOI 10.17487/RFC3473, January 2003, <<http://www.rfc-editor.org/info/rfc3473>>.
- [RFC3550] Schulzrinne, H., Casner, S., Frederick, R., and V. Jacobson, "RTP: A Transport Protocol for Real-Time Applications", STD 64, [RFC 3550](#), DOI 10.17487/RFC3550, July 2003, <<http://www.rfc-editor.org/info/rfc3550>>.
- [RFC4203] Kompella, K., Ed. and Y. Rekhter, Ed., "OSPF Extensions in
Support of Generalized Multi-Protocol Label Switching (GMPLS)", [RFC 4203](#), DOI 10.17487/RFC4203, October 2005, <<http://www.rfc-editor.org/info/rfc4203>>.
- [RFC4655] Farrel, A., Vasseur, J., and J. Ash, "A Path Computation Element (PCE)-Based Architecture", [RFC 4655](#), DOI 10.17487/RFC4655, August 2006, <<http://www.rfc-editor.org/info/rfc4655>>.
- [RFC5307] Kompella, K., Ed. and Y. Rekhter, Ed., "IS-IS Extensions in Support of Generalized Multi-Protocol Label Switching (GMPLS)", [RFC 5307](#), DOI 10.17487/RFC5307, October 2008, <<http://www.rfc-editor.org/info/rfc5307>>.
- [RFC5316] Chen, M., Zhang, R., and X. Duan, "ISIS Extensions in Support of Inter-Autonomous System (AS) MPLS and GMPLS Traffic Engineering", [RFC 5316](#), DOI 10.17487/RFC5316, December 2008, <<http://www.rfc-editor.org/info/rfc5316>>.
- [RFC5392] Chen, M., Zhang, R., and X. Duan, "OSPF Extensions in Support of Inter-Autonomous System (AS) MPLS and GMPLS Traffic Engineering", [RFC 5392](#), DOI 10.17487/RFC5392, January 2009, <<http://www.rfc-editor.org/info/rfc5392>>.
- [RFC5673] Pister, K., Ed., Thubert, P., Ed., Dwars, S., and T. Phinney, "Industrial Routing Requirements in Low-Power
and Lossy Networks", [RFC 5673](#), DOI 10.17487/RFC5673, October 2009, <<http://www.rfc-editor.org/info/rfc5673>>.
- [RFC5921] Bocci, M., Ed., Bryant, S., Ed., Frost, D., Ed., Levrau, L., and L. Berger, "A Framework for MPLS in Transport Networks", [RFC 5921](#), DOI 10.17487/RFC5921, July 2010, <<http://www.rfc-editor.org/info/rfc5921>>.

- [RFC6372] Sprecher, N., Ed. and A. Farrel, Ed., "MPLS Transport Profile (MPLS-TP) Survivability Framework", [RFC 6372](#), DOI 10.17487/RFC6372, September 2011, <<http://www.rfc-editor.org/info/rfc6372>>.
- [RFC6658] Bryant, S., Ed., Martini, L., Swallow, G., and A. Malis, "Packet Pseudowire Encapsulation over an MPLS PSN", [RFC 6658](#), DOI 10.17487/RFC6658, July 2012, <<http://www.rfc-editor.org/info/rfc6658>>.
- [RFC7384] Mizrahi, T., "Security Requirements of Time Protocols in Packet Switched Networks", [RFC 7384](#), DOI 10.17487/RFC7384, October 2014, <<http://www.rfc-editor.org/info/rfc7384>>.
- [RFC7426] Haleplidis, E., Ed., Pentikousis, K., Ed., Denazis, S., Hadi Salim, J., Meyer, D., and O. Koufopavlou, "Software-Defined Networking (SDN): Layers and Architecture Terminology", [RFC 7426](#), DOI 10.17487/RFC7426, January 2015, <<http://www.rfc-editor.org/info/rfc7426>>.
- [TEAS] IETF, "Traffic Engineering Architecture and Signaling", <<https://datatracker.ietf.org/doc/charter-ietf-teas/>>.
- [WirelessHART] www.hartcomm.org, "Industrial Communication Networks - Wireless Communication Network and Communication Profiles - WirelessHART - IEC 62591", 2010.

Authors' Addresses

Norman Finn
Huawei Technologies Co. Ltd
3755 Avocado Blvd.
PMB 436
La Mesa, California 91941
US

Phone: +1 925 980 6430
Email: norman.finn@mail01.huawei.com

Pascal Thubert
Cisco Systems
Village d'Entreprises Green Side
400, Avenue de Roumanille
Batiment T3
Biot - Sophia Antipolis 06410
FRANCE

Phone: +33 4 97 23 26 34
Email: pthubert@cisco.com

Balazs Varga
Ericsson
Konyves Kalman krt. 11/B
Budapest 1097
Hungary

Email: balazs.a.varga@ericsson.com

Janos Farkas
Ericsson
Konyves Kalman krt. 11/B
Budapest 1097
Hungary

Email: janos.farkas@ericsson.com

