

DMM Working Group
Internet-Draft
Intended status: Standards Track
Expires: September 22, 2016

M. Liebsch
NEC
S. Matsushima
SoftBank
S. Gundavelli
Cisco
D. Moses
Intel Corporation
L. Bertz
Sprint
March 21, 2016

Protocol for Forwarding Policy Configuration (FPC) in DMM
draft-ietf-dmm-fpc-cdp-02.txt

Abstract

This specification supports the separation of the Control-Plane for mobility- and session management from the Data-Plane. The protocol semantics abstract the configuration of Data-Plane nodes and applies it between a Client function, which is used by an application of the mobility Control-Plane, and an Agent function, which is associated with the configuration of Data-Plane nodes, according to the Data-Plane rules issued by the mobility Control-Plane. The scope of the rules comprises traffic description and treatment of packets in terms of encapsulation, IP address re-writing and QoS. Additional protocol semantics are described to support the maintenance of the Data-Plane path.

Status of This Memo

This Internet-Draft is submitted in full conformance with the provisions of [BCP 78](#) and [BCP 79](#).

Internet-Drafts are working documents of the Internet Engineering Task Force (IETF). Note that other groups may also distribute working documents as Internet-Drafts. The list of current Internet-Drafts is at <http://datatracker.ietf.org/drafts/current/>.

Internet-Drafts are draft documents valid for a maximum of six months and may be updated, replaced, or obsoleted by other documents at any time. It is inappropriate to use Internet-Drafts as reference material or to cite them other than as "work in progress."

This Internet-Draft will expire on September 22, 2016.

Internet-Draft

DMM FPC Protocol

March 2016

Copyright Notice

Copyright (c) 2016 IETF Trust and the persons identified as the document authors. All rights reserved.

This document is subject to [BCP 78](#) and the IETF Trust's Legal Provisions Relating to IETF Documents (<http://trustee.ietf.org/license-info>) in effect on the date of publication of this document. Please review these documents carefully, as they describe your rights and restrictions with respect to this document. Code Components extracted from this document must include Simplified BSD License text as described in Section 4.e of the Trust Legal Provisions and are provided without warranty as described in the Simplified BSD License.

Table of Contents

1.	Introduction	3
2.	Conventions and Terminology	4
3.	Reference Architecture and Deployment Options	4
3.1.	Architecture for DMM Forwarding Policy Configuration . .	4
3.2.	Model 1	6
3.2.1.	Role of the FPC Client Function	7
3.2.2.	Role of the FPC Agent Function	7
3.3.	Model 2	8
3.3.1.	Role of the DMM FPC Client Function	8
3.3.2.	Role of the DMM FPC Agent Function	8
4.	Protocol to support Model I	9
4.1.	Data Structure	9
4.2.	Protocol Attributes	12
4.3.	Protocol Messages and Semantics	19
4.4.	Protocol Operation	20
5.	Protocol to support Model II	29
5.1.	Protocol Attributes	29
5.2.	Protocol Messages and Semantics	31
5.3.	Protocol Operation	33
6.	YANG Data Model for the FPC protocol	34
6.1.	FPC Base	34
6.1.1.	FPC Base YANG Model	34
6.1.2.	FPC Base tree	51
6.2.	FPC PMIP	57
6.2.1.	FPC PMIP YANG Model	57
6.2.2.	FPC PMIP tree	60

7.	Security Considerations	65
8.	IANA Considerations	65
9.	Work Team Participants	66
10.	References	66
10.1.	Normative References	66

10.2.	Informative References	66
Authors'	Addresses	67

[1.](#) Introduction

One objective of the Distributed Mobility Management (DMM) WG is the separation of the mobility management Control- and Data-Plane to enable flexible deployment, such as decentralized provisioning of Data-Plane nodes (DPN). Data-Plane nodes can be configured to function as an anchor for a registered Mobile Node's (MN) traffic, others can be configured to function as a Mobile Access Gateway (MAG) per the Proxy Mobile IPv6 protocol [[RFC5213](#)] or a Foreign Agent (FA) per the Mobile IPv4 protocol [[RFC3344](#)]. Requirements for DMM have been described in [[RFC7333](#)], whereas best current practices for DMM are documented in [[RFC7429](#)].

The Data-Plane must provide a set of functions to the Mobility Control-Plane, such as support for encapsulation, IP address re-writing, QoS differentiation and traffic shaping. In addition, means for traffic description must be provided to complement traffic treatment actions and build unambiguous Data-plane rules. These requirements are met by various transport network components, such as IP switches and routers, though configuration semantics differ between them.

Forwarding Policy Configuration (FPC) per this document enables the configuration of any Data-Plane node and type by the abstraction of configuration details and the use of common configuration semantics. The protocol using the FPC semantics is deployed between a Client function, which is associated with the Mobility Management Control-Plane, and an Agent function. The Agent function enforces the Data-Plane configuration and can be present on a transport network controller or co-located with a Data-Plane node. The Agent applies the generalized configuration semantics to configuration, which is specific to the Data-Plane node and type.

This specification follows a common functional architecture, which utilizes the FPC protocol between the Client and Agent functions, and supports two operational models, Model I and Model II.

A Client supporting Model I interacts with the Agent to build unambiguous rules which are to be enforced in the Data-Plane. An Agent supporting Model I translates a rule, which follows the data model herein, into one or multiple configuration actions to enforce the rule in the Data-Plane.

A Client supporting Model II utilizes a sequence of control messages to interact with the Agent, where each control message has an

unambiguous semantic, e.g. to set up a tunnel interface or to configure a policy route in a Data-Plane node. An Agent supporting Model II performs a configuration action per the semantics of the received control message.

The availability of both operational models enables tailored implementation and deployment of Control-/Data-Plane separation in mobile communication gateways, e.g. by having the Mobility Control-Plane directly communicating to a Data-Plane node as per Model II, or per Model I by the deployment of a Network Controller in between the Mobility Control-Plane and Data-Plane nodes, which are under control of the Network Controller. Support for both the models enables an operator to transition their network in incremental phases.

The architecture and reference interface specified in this document is not tied to any specific Control-Plane protocol that is in use in the mobility network, or to any type of access technology. The mobility protocols in use can be Proxy Mobile IPv6, GTP, IPSec or other protocols; and the access network can be 4G LTE, WiFi, or 5G. These aspects have no direct implication on the FPC interface that is between Control- and Data-Plane nodes.

2. Conventions and Terminology

The key words "MUST", "MUST NOT", "REQUIRED", "SHALL", "SHALL NOT", "SHOULD", "SHOULD NOT", "RECOMMENDED", "MAY", and "OPTIONAL" in this document are to be interpreted as described in [[RFC2119](#)].

3. Reference Architecture and Deployment Options

3.1. Architecture for DMM Forwarding Policy Configuration

The DMM Forwarding Policy Configuration (FPC) protocol enables the separation of the mobility management Control-Plane from the Data-Plane and provides the required control and semantics in between these two planes. Figure 1 depicts an exemplary use case where IP traffic between a Correspondent Node (CN) and a Mobile Node (MN) traverses multiple DPNs, each applying policies as per the Control-Plane's request. Policies in the one or multiple DPNs can result in traffic steering according to a host-route, packet scheduling and marking according to a subscriber's QoS profile, or forwarding rules (e.g. encapsulation within GRE or GTP-U tunnel).

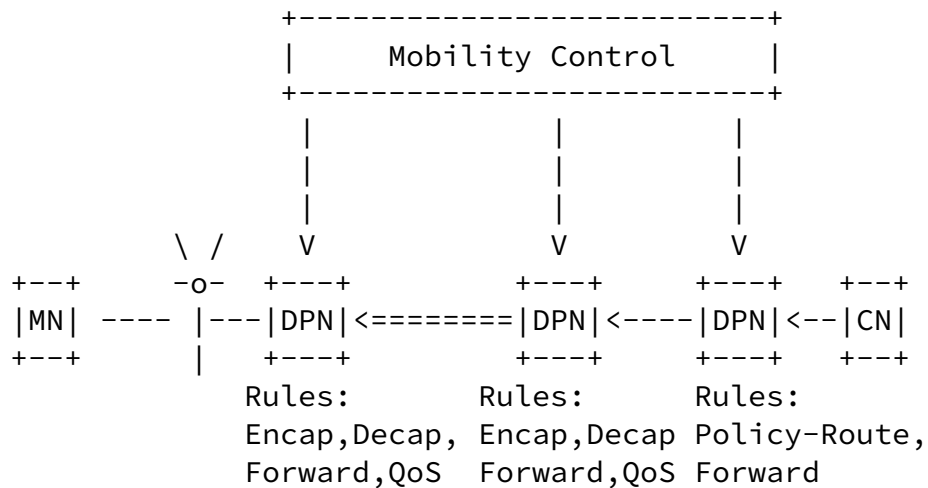

Figure 1: Exemplary illustration of DMM traffic steering and policy enforcement at Data Plane Nodes (DPN)

Mobility Control-Plane functions have the following roles in common:

- o Tracking a mobile node's attachment, detachment from the access network

- o Accept requests to set up and maintain mobility-related Data-Plane paths between DPNs, enforcing QoS and forwarding policies. Such requests are a result of mobility signaling between different Mobility Control-Plane functions.
- o Ensure that required rules to establish and maintain connectivity of an MN with its correspondent nodes are enforced in the Data-Plane.
- o Participate in monitoring the DPNs' operation and support the handling of exceptions, e.g. the detection of a partial DPN failure and the diversion of traffic through a different DPN.
- o Maintain consistency between multiple DPNs which enforce policy rules to ensure connectivity between a MN and its correspondent services.

Mobility Data-Plane functions have the following roles in common:

- o Forward and treat traffic according to the policies and directives sent by the Mobility Control-Plane
- o Provide status information (e.g. load, health, statistics and traffic volume) and events related to service failure upon request

- o Participate in the process of topology acquisition, e.g. by exposing relevant topological and capability information, such as support for QoS differentiation and supported encapsulation protocols

The protocol for DMM FPC applies to the interface between a FPC Client function and a FPC Agent function, as depicted in Figure 2. The FPC Client function is associated with an application function of the mobility management Control-Plane, e.g. a Local Mobility Anchor Control-Plane function per the Proxy Mobile IPv6 protocol. The FPC Agent function processes the FPC protocol semantics and translates them into configuration commands per the DPN's technology. In one example, an FPC Agent can be co-located with a Network Controller, which enforces forwarding rules on a set of Data-plane nodes. In another example, the Agent can be co-located with a Data-Plane node

to directly interact with interface management and the router's RIB Manager. The mapping of the common FPC semantics and policy description to the configuration commands of a particular DPN is specific to the DPN's technology and the Agent's implementation.

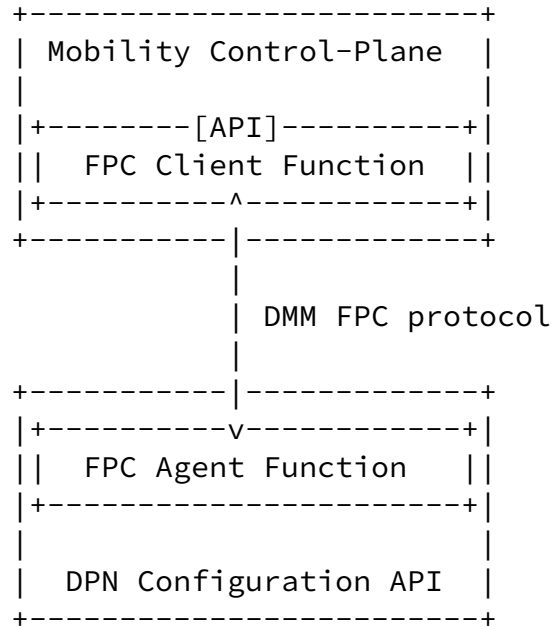

Figure 2: Functional reference architecture for DMM Forwarding Policy Configuration (FPC)

[3.2.](#) Model 1

[3.2.1.](#) Role of the FPC Client Function

The FPC Client function, which follows Model I operation, includes the following tasks:

- o Build one or multiple FPC Control messages/attributes to establish, update or delete rules on one or multiple DPN(s) according to the Mobility Control-Plane's directives

- o Apply a DPN's policy rules (encapsulation, address re-write, QoS, traffic monitoring) on the basis of properties bound to logical ports (similar to the bearer concept in cellular networks)
- o Build, modify or delete logical ports as needed
- o Bind associated policy rules as one or multiple properties to a logical port
- o Apply traffic forwarding rules (e.g. per-IP flow, per-MN, per-IP, per-prefix) on the basis traffic descriptions bound to logical ports
- o Send each generated FPC control message to the FPC Agent
- o Keep record of the configured policy rules and interact with the FPC Agent to ensure proper synchronization between Mobility Control-Plane states and rules configured on the FPC Agent
- o Process received Response, Notification and Query messages issued by a FPC Agent and interact with the Control-Plane to act accordingly

3.2.2. Role of the FPC Agent Function

The FPC Agent function, which follows Model I operation, includes the following tasks:

- o Process received Control messages issued by a FPC Client Function
- o Apply received rules to local configuration (e.g. encapsulation, NA(P)T, traffic prioritization and scheduling) in the Data-Plane
- o Maintain administrative data as well as operational data, which describes the status of the rules in the Data-Plane
- o Monitor events (e.g. failure, incomplete rule) and issue an associated message to the FPC Client Function (NOTIFICATION, QUERY)

3.3. Model 2

3.3.1. Role of the DMM FPC Client Function

The FPC Client function, which follows Model II operation, includes the following tasks:

- o The FPC Client offers a set of services to the mobility control plane entities. These services are for activating/deactivating specific configuration on a Data-Plane node supported by a FPC Agent. These services for example are creation/deletion of a layer-3 tunnel; adding/deleting an IP route;
- o The FPC Client translates the request from the mobile control plane as a FPC message. The message identifies the service name and includes a set of information elements. This message is sent to the FPC Agent over the FPC interface.

3.3.2. Role of the DMM FPC Agent Function

The FPC Agent function, which follows Model II operation, includes the following tasks:

- o FPC Agent offers a set of services to the FPC client. Each of these services have a well-defined meaning and can be invoked by the FPC Client passing a set of parameters. These services for example are creation/deletion of a layer-3 tunnel; adding/deleting an IP route.
- o Any FPC Client can invoke a specific service on the FPC Agent through the use of FPC messaging interface. The interface semantics allow the identification of the service request and for inclusion of the parameters relevant for that service request.
- o FPC Agent processes a FPC message and identifies the service request. The FPC Agent maps the service request to a local configuration and enables that configuration in the forwarding plane. For example, if there is a service request for Tunnel creation including the relevant parameters such as source IP address, destination IP address and encapsulation type, this request will result in the FPC Agent configuring such tunnel configuration on the Data-Plane node.
- o The FPC Agent provides a resulting status code on how the request was executed by the agent.

[4.](#) Protocol to support Model I

[4.1.](#) Data Structure

To abstract from configuration details of an IP switch or IP router on the FPC protocol interface, Model I adopts the construct of logical ports to describe rules for D-Plane processing. A port binds one or multiple properties, which describe traffic treatment actions, such as a QoS policy, IP address re-write or packet encapsulation. Which traffic is treated is determined by one or multiple traffic descriptors, which also bind to that port. A group of one or multiple traffic descriptors, one or multiple properties defining traffic treatment actions and the port identifier make a rule. The port identifier serves as key to access the rule.

All traffic arriving at a Data-Plane node and matching a traffic descriptor will be treated per the properties bound to the port the traffic descriptor is also bound to. For example, Traffic Selectors [[RFC6088](#)], which can be bound to a port, can identify single or multiple IP flows. Aggregated IP traffic destined toward a given IP address prefix or originated from an address matching a particular IP address range can be described using the Traffic Selector or an IP prefix traffic descriptor per this specification.

In addition to traffic descriptors and traffic treatment actions, which build a Data-Plane processing rule, a port has associated operational data, which tracks the status of rule enforcement in a selected Data-Plane node. A rule can also have administrative data such as its directionality (uni- or bi-directional) and administrative status such as enabled, disabled or virtual. Furthermore, an identifier of the Data-Plane node to which the rule applies is kept in the operational data associated with a port.

When the Client desires specific operational state for the port, it may apply administrative state properties to the port. This, however, may not take immediate effect on the Data-Plane Node. Thus, Client implementations must support situations where differences exist between configured and operational state of a port. A Client can request operational data associated with a particular port from an Agent.

A Client adds, modifies or deletes a rule on an Agent using the FPC protocol messages. The protocol enables a Client to provide additional administrative information about a particular port or a group of ports to the Agent. This includes control of the operation of a rule, e.g. whether a rule associated with a particular port

applies only uni-directionally or bi-directionally. In case of bi-directionality, an Agent can apply a rule associated with a single

port in the Data-Plane to both directions. As example, a rule which performs re-writing of an arriving packet's destination IP address from IP_A to IP_B matching an associated Traffic Selector, can be enforced in the Data-Plane via an Agent to implicitly consider matching arriving packet's source IP address against IP_B and re-write the source IP address to IP_A.

Figure 3 illustrates the generic policy configuration model as used between a FPC Client and a FPC Agent.

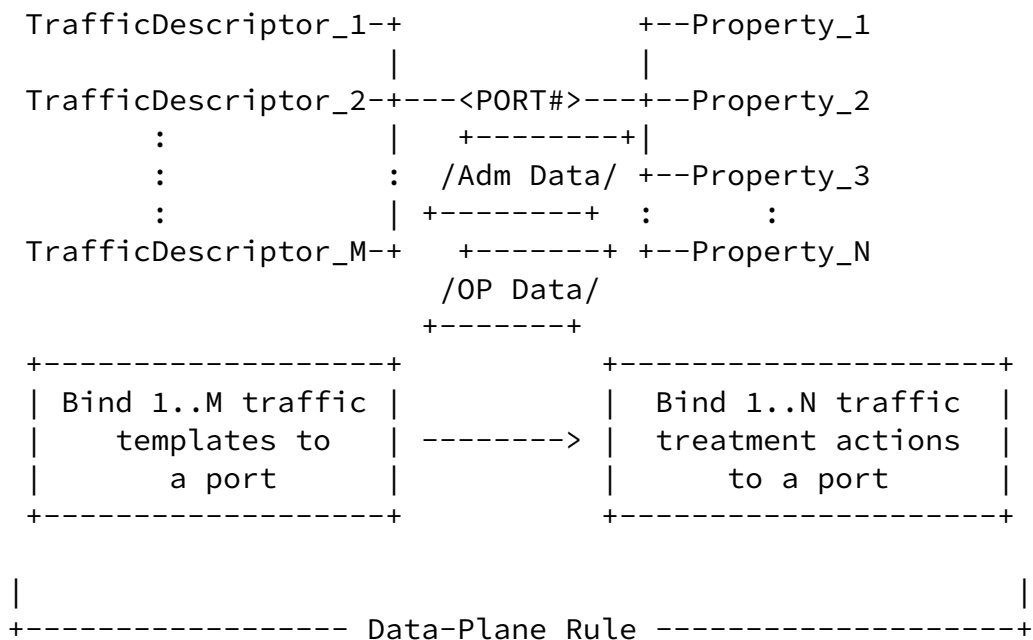

Figure 3: Structure of rules on Client/Agent defining Data-Plane traffic treatment

As depicted in Figure 3, the port represents the anchor of a rule. A Client and Agent use the identifier of a port to access the rule and perform modifications of traffic descriptors or properties. From the viewpoint of packet processing, arriving packets are matched against traffic descriptors and processed according to the treatment actions specified in the list of properties associated with the port.

A Client can assign an existing or new port to a group of ports using a port group identifier. The logic behind grouping multiple ports is up to the Control-Plane. As example, multiple rules associated with a single mobile node can be grouped and identified by the port group identifier. In case the Control-Plane needs to delete all rules associated with the mobile node, the Client can issue a message to delete a port one and identify the group group identifier instead of deleting each port individually. A Client can also apply

administrative properties to a group of ports by adding the port group ID to the FPC message.

A Client can complement a traffic descriptor with a match priority value to allow unambiguous traffic matching on the Data-Plane. If the Client does not provide a match priority value with a traffic descriptor or a group of traffic descriptors have the same priority value, an Agent enforces the rule in the Data-Plane node to enable traffic detection by longest prefix match.

Operational information of a port includes the data listed in the following table:

Admin Data	Format Clarification	Description
DPN_ID	Sect. 4.2	Identifies a Data-Plane node to which the rule applies
PRT_BIDIR	BOOLEAN	Bidirectionality of a port (cleared = unidirectional)
ADMIN_STATUS	[8, admin status]	Requested status for a rule in a Data-Plane node (enabled, disabled, virtual)
SESSION_STATUS	[8, session status]	Status of a session in the Control-Plane (complete, incomplete, outdated)
PRT_GROUP_ID	[32, group id]	Identifies a group of ports to which this port belongs

CLI_ID	Sect. 4.2	Identifies the Client which created this port
AGT_ID	Sect. 4.2	Identifies the Agent which enforces the rule as per this port

Figure 4: Administrative Data associated with a port

Operational Data	Format Clarification	Description
OPER_STATUS	[8, oper status]	Status of a rule in a Data-Plane node (enabled, disabled, virtual)
SERVICE_STATUS	[8, service status]	Ability of an enabled rule to serve traffic (complete, incomplete, outdated)

Figure 5: Operational Data associated with a port

A Client MAY apply an administrative state property to a port indicating the desired operational status of a port, e.g. enabled, disabled or virtual (not intended to serve traffic but used as a template for other ports). Rules specified by an enabled port are enforced in the Data-Plane node. A disabled port on an Agent can be useful for pre-configuration, e.g. other operations can be performed on the port prior to its enablement. Ultimately, a disabled port is intended to be enabled. Virtual ports can serve as a reference to clone new ports, which can then be enabled. When creating a cloned port, the Client can update or add properties to suit the rule that should be enforced in the Data-Plane.

A Client MAY set a Session state for a particular port or group of ports on the Agent to guide the Agent on how to treat local events. As example, an Agent SHOULD refrain from sending an FPC message to the Client as result of a local event, which indicates a missing rule, in case the session state is 'incomplete', as the Agent can expect the Control-Plane to provide the missing rule unsolicited. In case the session state is 'outdated', the Agent MAY notify the Client to update the associated rule on the Agent.

[4.2.](#) Protocol Attributes

Protocol messages as per [Section 4.3](#) identify an FPC Client or Agent function, as well as a DPN, and carry traffic descriptor attributes, logical port identification and properties specifying traffic treatment actions. Traffic can be described per-host, in aggregate or per-IP flow. A Client MAY append administrative properties to a message to indicate the desired status of a port to the Agent.

This document specifies attributes from the following categories:

- o Identifier attributes

- o Traffic Descriptors
- o Properties specifying traffic treatment actions
- o Protocol-specific Properties
- o Administrative properties

Attribute	Format Clarification	Description
Identifiers		
PRT_ID	[32,PRT_ID]	Identifies a logical Port
PRT_GROUP_ID	[32,PRT_GROUP_ID]	Identifies a group of logical Ports
PRT_PROP_ID	[32,PRT_ID]	Identifies a logical Port

	[8,PROP_ID]	and one of its properties
PRT_TD_ID	[32,PRT_ID] [8,TD_ID]	Identifies a logical Port and a traffic descriptor that applies to the port
CLI_ID	[16, Carrier ID] [16, Network ID] [32, Client ID]	Identifies an FPC Client function
AGT_ID	[16, Carrier ID] [16, Network ID] [32, Agent ID]	Identifies an FPC Agent function
DPN_ID	[16, Carrier ID] [16, Network ID] [32, DPN ID]	Identifies a Data Plane Node (DPN)
MONITOR_ID	[32, Monitor ID]	Identifies a registered monitor
EVENT_TYPE_ID	[8, Event Type ID]	Identifies an event type
Optional Identifiers		
SERVICE_PATH_ID	[24-bit identifier]	Service Path Identifier

Figure 6: Model I Protocol Attributes: Identifiers

Attribute	Format Clarification	Description
Properties		
PROP_TUN	[type][src][dst]	Property Encapsulation,
		indicates type GRE, IP, GTP
PROP_REWR	[in_src_ip][out_src_ip]	Property NAT defines

	[in_dst_ip][out_dst_ip] [in_src_port][out_src_port] [in_dst_port][out_dst_port]	IP address and port re-write rules
PROP_QOS	[QoS index type][index] [DSCP]	Property QoS refers to single index and DS Code Point to write
PROP_QOS_GBR	[GBR] *[PRT_ID]	Guaranteed Bit Rate and single or multiple PRT_IDs to which the GBR applies when being aggregated
PROP_QOS_MBR	[MBR] *[PRT_ID]	Maximum Bit Rate and single or multiple PRT_IDs to which the MBR applies when being aggregated
PROP_GW	[ip address next hop]	IP address of the Next Hop to which IP packets should be forwarded
PROP_CPY_FORW	[PRT_ID]	Copy IP packets, treat the duplicates per the properties of the referred port
PROP_DROP		Drop IP packet
PROP_CONCAT	[PRT_ID]	Include treatment per the referred port into the rule
Optional Properties		
PROP_NSH	[SERVICE_PATH_ID] [Service Index]	Include NSH

Figure 7: Model I Protocol Attributes: Traffic Treatment Properties

Attribute	Format Clarification	Description
Protocol-specific		
IPIP_CONF		IP-encapsulation configuration attribute
GRE_CONF	[prototype][seq-#] [key]	GRE_encapsulation configuration attribute
GTP_CONF	[TEID_local] [TEID_remote] [seq-#]	GTP-U encapsulation configuration attribute

Figure 8: Model I Protocol Attributes: Protocol-specific

Attribute	Format Clarification	Description
Traffic Descriptor Container		
TD_CONTAINER	[PRT_TD_ID] [8, PRIO] *[traffic descriptor]	Traffic handling priority, One or multiple traffic descriptors

Figure 9: Protocol Attributes: Traffic Description Container

Attribute	Format Clarification	Description
Traffic Descriptors		
TD_DST_IP	[IP address] [Prefix Len]	Aggregated or per-host dst IP address/prefix rule
TD_SRC_IP	[IP address] [Prefix Len]	Aggregated or per-host src IP address/prefix rule
TD_TS	[Traffic Selector]	Traffic Selector, Format as per RFC6088

Figure 10: Protocol Attributes: Traffic Descriptors

Internet-Draft

DMM FPC Protocol

March 2016

Attribute	Format Clarification	Description
Properties		
ADMIN_STATE	[state]	Administrative state: enabled, disabled, virtual
SESSION_STATE	[state]	Session state: complete, incomplete, outdated
CLONE_REF	[PRT_ID]	Cloning of a rule based on referred port ID
ACT_DELAY	[delay]	Delay in ms before an updated rule takes effect at the Agent
PRT_BIDIR	[boolean]	When set, the rule per this port is applied bi-directionally
RESULT	[result]	Result of processing a message: success, failure

Figure 11: Protocol Attributes: Administrative Properties

Internet-Draft

DMM FPC Protocol

March 2016

Attribute	Format Clarification	Description
Monitors and Notification		
MONITOR	Monitor-ID Attribute [REPORT CONFIG]	A Monitor
REPORT_CONFIG	[8, REPORT-TYPE] [TYPE_SPECIFIC_INFO]	The type of report and type-specific configurations
PERIODIC_CONFIG	[32, period]	REPORT-TYPE is PERIODIC, period specifies the report interval (ms)
THRESHOLD_CONFIG	[32, low] [32, hi]	REPORT-TYPE is THRESHOLD, Low Threshold, High Threshold (at least one value required)
SCHEDULED_CONFIG	[32, time]	REPORT-TYPE is SCHEDULED, Time when NOTIFY is sent
EVENTS_CONFIG	*[EVENT_TYPE_ID]	List of Events that trigger the Monitor
DEREG_INFO	*[MONITOR_ID] [boolean]	Monitors to deregister, Boolean (optional) indicates if a successful DEREG triggers a NOTIFY with final data

NOTIFY_INFO	[32, Notification-Id]	ID used for Client ordering
	[MONITOR-ID]	Monitor-ID of the NOTIFY,
	[32, TRIGGER]	TRIGGER for the NOTIFY,
	[32, timestamp]	Timestamp of when the
		attributes were recorded

Figure 12: Protocol Attributes: Monitor and Notify Attributes

TRIGGERS include but are not limited to the following values:

- o Events specified in the Event List of an EVENTS CONFIG
- o LOW_THRESHOLD_CROSSED

- o HIGH_THRESHOLD_CROSSED
- o PERIODIC_REPORT
- o SCHEDULED_REPORT
- o PROBES
- o DEREG_FINAL_VALUE

[4.3.](#) Protocol Messages and Semantics

The following table specifies all protocol messages to create and modify a rule by creating and deleting logical Ports, adding and modifying properties and binding traffic descriptors to a port. Furthermore, messages can schedule tasks, such as monitoring, at an Agent or probe the status of the scheduled task from a Client. Additional messages enable the Data-Plane to notify or query the Control-Plane through the Agent and Client functions.

Message	Description
Messages issued by the FPC Client	
PRT_ADD	Add a logical port
PRT_DEL	Delete a logical port
PROP_ADD	Add a property to a logical port
PROP_MOD	Modify a property of a logical port
PROP_DEL	Delete a property from a logical port
TD_ADD	Add traffic descriptor to a logical port
TD_MOD	Modify an existing traffic descriptor

TD_DEL	Delete an existing traffic descriptor
MONITOR_REG	Install a monitor at an Agent. The message includes information about the attribute to monitor and the reporting method.
MONITOR_DEREG	Remove a monitor at an Agent.
PROBE	Probe the status of a registered event
Messages issued by the FPC Agent	
NOTIFY	Notify the Client about the status of a monitored attribute per the reporting method (periodic / event trigger / probed)
QUERY	Query the Client about missing rules/states

Figure 13: Protocol Messages

4.4. Protocol Operation

The following list comprises a more detailed description of each message's semantic.

An FPC Client and Agent MUST identify themselves using the CLI_ID and AGT_ID respectively to ensure that for all transactions a recipient of an FPC message can unambiguously identify the sender of the FPC

message. A Client MAY direct the Agent to enforce a rule in a particular DPN by including a DPN_ID value. Otherwise the Agent selects a suitable DPN to enforce a rule and notifies the Client about the selected DPN using the DPN_ID.

- o PRT_ADD - Issued by a Client to add a new logical port at an Agent. An Agent receiving the PRT_ADD message identifies the new port according to the included port identifier (PRT_ID). The Agent adds a new port into its conceptual data structures using the port identifier as key. Optionally, the PRT_ADD message MAY include properties as well as traffic descriptors, which are bound and refer to the new port. This enables a Client to issue a new

configuration in a single transaction with an Agent. A Client MAY assign a port to a group of ports and indicate the associated port group identifier (PRT_GROUP_ID) in the PRT_ADD message.

- o PRT_DEL - Used by a Client to delete a port. An Agent receiving such message MUST delete all properties associated with the identified port.
- o PROP_ADD - Used by the Client to add a new property to an existing port. The property is unambiguously identified through a property identifier (PRT_PROP_ID). All traffic, which is directed to this port is treated according to the existing and newly added property. Optionally, the PROP_ADD message can include traffic descriptors, which refer to the port to which the properties are bound. This enables a Client to add new rules to the existing port to which the new properties have been bound in a single transaction.
- o PROP_MOD - Used by a Client to modify an existing property. For example, a tunnel property can be changed to direct traffic to a different tunnel endpoint in case of a mobile node's handover. Optionally, the PROP_MOD message can include rules descriptions, which refer to the port whose properties are modified. This enables a Client to add new rules to the existing port whose properties have been modified in a single transaction.
- o PROP_DEL - Used by a Client to delete one or multiple properties, each being identified by a property identifier.
- o TD_ADD - Used by a Client to add a traffic descriptor to a port. The traffic descriptor SHOULD unambiguously identify aggregated traffic (longest prefix), per host IP traffic or per-flow traffic in the TD_ADD command and bind the identified traffic to a port. Traffic descriptors are carried in a TD_CONTAINER, which allows the identification of a traffic description as well as the indication if a traffic handling priority in case the sole traffic

description does not suffice unambiguous traffic matching. An Agent receiving a TD_ADD command MUST add the traffic descriptor to its local conceptual data structures and apply commands for local configuration to add the new traffic descriptor to the rule on the DPN. Multiple traffic descriptors can bind to the same

port. All traffic captured by the traffic descriptor will experience the same treatment per the properties which bind to that port.

- o TD_MOD - Used by a Client to modify an existing traffic descriptor. An Agent receiving such messages MUST apply commands to the local configuration and update the rule on the DPN accordingly.
- o TD_DEL - Used to remove an existing traffic descriptor from a port. The Agent receiving such messages MUST delete the identified traffic descriptor from the local configuration and update the rule on the DPN accordingly.
- o MONITOR_REG - Used by a Client to install a monitor at an Agent. A monitor contains the monitor id, attribute to monitor, and optional reporting configuration. The attribute may be any ID with the exception of MONITOR_ID and EVENT_TYPE_ID. When a Monitor registration is applied, the reporting configuration MUST be applicable to the attribute monitored, e.g. a Monitor using a Threshold configuration cannot be applied to a Port but it can be applied to a numeric Port Property. Four report types are defined: (1) Periodic reporting specifies an interval by which a NOTIFY is sent to the Client, (2) Event reporting specifies a list of EVENT_TYPE_IDS that, if they occur and are related to the monitored attribute, will result in sending a NOTIFY to the Client, (3) Scheduled reporting specifies the time (in seconds since Jan 1, 1970) when a NOTIFY for the monitor should be sent to the Client. Once this Monitor's NOTIFY is completed the Monitor is automatically de-registered, (4) Threshold reporting specifies one or both of a low and high threshold. When these values are crossed a corresponding NOTIFY is sent to the Client. All monitored data can be requested by the Client at any time using the PROBE message. Thus, reporting configuration is optional and when not present only PROBE messages may be used for monitoring. If a SCHEDULED or PERIODIC configuration is provided during registration with the time related value (time or period respectively) of 0 a NOTIFY is immediately sent and the monitor is immediately de-registered. This method should when a MONITOR has not been installed, an immediate NOTIFY is sufficient for the Client's needs and the Client has no further need for the monitor to be registered. An Agent may reject a registration if it or the DPN has insufficient resources.

- o MONITOR_DEREG - Used by a Client to remove a monitor from an Agent. The message identifies one or multiple monitors by including the MONITOR_ID. The message also includes an optional Boolean value that, when true, will result in NOTIFY messages being sent for the MONITOR_ID to the Client. When a monitor has a reporting configuration of SCHEDULED it is automatically de-registered after the NOTIFY occurs. An Agent or DPN may temporarily suspend monitoring if insufficient resources exist. In such a case the Agent MUST notify the Client.
- o PROBE - Used by a Client to retrieve information about a previously installed monitor. The PROBE message SHOULD identify one or more monitors by means of including the associated monitor identifier. An Agent receiving a PROBE message SHOULD send the requested information in a single or multiple NOTIFY messages.
- o NOTIFY - Used by an Agent to report the status of a monitor to a Client. This message contains the MONITOR_ID, a NOTIFICATION_ID to permit the Client to distinguish amongst many monitoring related requests, a TRIGGER that caused the NOTIFY message, the timestamp of when the monitored information was recorded for the message along with the value of the monitored attribute.
- o QUERY - Used by an Agent to request an update of port properties via a Client. The Agent adds one or multiple port identifiers to the QUERY message to request all properties associated with the identified port(s). The Agent MAY request the update of particular properties associated with a port by including the property and its identifier. As result of processing a QUERY message, the Client sends one or multiple PROP_MOD messages with the requested properties to the Agent.

All messages sent from a Client to an Agent MUST be acknowledged by the Agent. The response must include all attributes as well as status information, which indicates the result of processing the message, using the RESULT property. In case the processing of the message results in a failure, the Agent sets the RESULT accordingly and MAY clear the property or traffic descriptor, which caused the failure, in the response.

A Client MAY add a property to a port without providing all required details of the attribute's value. In such case the Agent SHOULD determine the missing details and provide the completed property description back to the Client. In case the Agent cannot determine the missing value of an attribute's value per the Client's request, it leaves the attribute's value cleared in the response and sets the RESULT to failure. As example, the Control-Plane needs to setup a tunnel configuration in the Data-Plane but has to rely on the Agent

Internet-Draft

DMM FPC Protocol

March 2016

to determine the tunnel endpoint which is associated with the DPN that enforces the rule. The Client adds the tunnel property attribute to the FPC message and clears the value of the attribute (e.g. IP address of the local tunnel endpoint). The Agent determines the tunnel endpoint and includes the completed tunnel property in its response to the Client.

The following list provides information on the use and semantics of attributes for traffic treatment:

- o PROP_TUN - Defines the properties for encapsulation into different tunnel headers. The property includes IP address information of tunnel endpoints as well as a type identifier specifying the encapsulation type. Further attributes may be included to provide information which is relevant for the configuration and initialization of the tunnel.
- o PROP_REWR - Defines the properties for IP address and port re-write.
- o PROP_QOS - Defines the QoS properties in terms of a known index type, e.g. LTE's Quality Class Index (QCI), and its value (QCI 1..9), as well as a Differentiated Services Code Point (DSCP) to classify and mark packets. Additional QoS attributes may follow, to define Guaranteed Bit Rate (GBR) and Maximum Bit Rate (MBR) bounds. PROP_QOS_GBR and PROP_QOS_MBR attributes can apply to a single port or multiple ports. The latter is required to configure aggregate bounds, such as Aggregate Maximum Bit Rate (AMBR), taking traffic, which is forwarded through different ports (hence experiencing different treatment), into account. In such case the GBR/MBR attributes append multiple PRT_ID attributes to identify the ports which are to be monitored to determine the aggregated view of the bit rate. As alternative to binding a PROP_QOS_MBR property to each port whose traffic is to be taken into account for Aggregate Maximum Bitrate (AMBR) metering, a Client can create a separate port with a single PROP_QOS_MBR property. Other ports, whose traffic is to be metered per the AMBR, can refer to the port with the PROP_QOS_MBR property using the PROP_CONCAT property. The scope of attributes for QoS is aligned to [\[RFC7222\]](#). The Allocation and Retention Priority (ARP) as per [\[RFC7222\]](#) is not present in the list of QoS-specific attributes, since ARP is treated and kept in the Control-Plane for

granting requests for new resources and QoS, as well as for preempting other QoS configuration, if needed.

- o PROP_QOS_GBR - Defines the GBR bound for traffic associated with a port.

- o PROP_QOS_MBR - Defines the MBR bound for traffic associated with a port.
- o PROP_GW - Defines a Next Hop IP address, to which packets are forwarded. Using this attribute, the Control-Plane can configure a host-route in the Data-Plane to deviate from default routes.
- o PROP_CPY_FORW - Refers to a different port and results in treatment of a copy of packets per the properties bound to the referred port.
- o PROP_DROP - Defines a treatment action to drop packets of traffic associated with a port. As example, this treatment action can be used to enforce gating rules and filter traffic which does not match any traffic descriptor.
- o PROP_CONCAT - Traffic can be treated per properties bound to concatenated ports. After treatment of traffic according to the properties of a port, additional treatment actions per the properties bound to a separate port, which is referred to in the PROP_CONCAT property, apply to the traffic. As example, port concatenation can be used to enable AMBR metering to traffic which is associated with multiple other ports.
- o PROP_NSH - Defines the properties for a Network Service Header (NSH). The header is included to the classified IP flows.

Unlike descriptors, overlapping or contradictory properties cannot be resolved by the Agent. For example, adding address translation related properties and a Drop property to a single port may result in needless activity in the DPN or it may reflect a temporary administrative activity where the port must Drop traffic. Other properties may be intentionally set, e.g. a property that invokes and accounting activity and a Drop property present on the same port. The FPC Client MUST avoid situations where contradictory properties

or those that result in unnecessary activity are added to ports. Rather, in such situations, multiple ports MUST be used. In some obvious cases the Agent MAY raise a warning but a contradictory action.

The following list provides information on the use and semantics of administrative properties:

- o ADMIN_STATE - A Client can apply an administrative state to a port indicating the desired operational status of a port (enabled, disabled, virtual). An Agent, which receives a message without ADMIN_STATE property, SHOULD consider the port to be 'enabled'.

- o SESSION_STATE - A Client can indicate to the Agent the status of a rule to serve Data-Plane traffic. A session state 'complete' confirms that a rule is valid and ready to serve Data-Plane traffic. A session state 'incomplete' hints to the Agent that more FPC message will arrive from the Client to complete a rule, whereas session state 'outdated' requires the Agent to solicit an update of the rule from the Client in case a rule with session state 'complete' is desired. An Agent, which receives a message without SESSION_STATE property, SHOULD assume the session state is 'complete'.
- o CLONE_REF - Instead of repeatedly sending all properties and traffic descriptors for similar rules, a Client can take a clone of a previously configured rule as base for a new one by using the CLONE_REF property with a PRT_ADD message and refer to an existing port. The cloned port will be a copy of the referred port and serve as base for the new port. The cloned port will have its own port identifier, which will also be present in the port identifier portion of the property identifiers. After a cloned port has been created, it represents its own rule without any further dependency on the reference port which served as source to create the clone. A Client MAY apply updates to existing properties of the new port, as well as delete or add properties. Updates to the port in terms of new or changed properties and traffic descriptors MAY already come with the PRT_ADD message or subsequently using messages to handle properties and traffic descriptors. A Client can use the CLONE_REF property with messages to handle properties and traffic descriptors to achieve a different result. In such case these

messages identify an existing port already and processing the CLONE_REF property on the receiving Agent will result in a reset of the identified port to match the properties of the port referred to in the CLONE_REF property.

- o ACT_DELAY - A Client can use this property to define a delay in ms before an updated rule takes effect at an Agent, e.g. an administrative state 'enabled' will be enforced by the Agent after the delay per the Client's request.
- o PRT_BIDIR - A Client uses this property to indicate to an Agent to apply a rule associated with a port bi-directionally. In case the PRT_BIDIR property is absent in a message, the Agent assumes a rule applies uni-directionally.
- o RESULT - An Agent uses this property to signal to the Client in a response the result of processing a message.

Figure 14 illustrates an exemplary session life-cycle based on Proxy Mobile IPv6 registration via MAG Control-Plane function 1 (MAG-C1)

and handover to MAG Control-Plane function 2 (MAG-C2). Edge DPN1 represents the Proxy CoA after attachment, whereas Edge DPN2 serves as Proxy CoA after handover. As exemplary architecture, the FPC Agent and the network control function are assumed to be co-located with the Anchor-DPN, e.g. a Router.

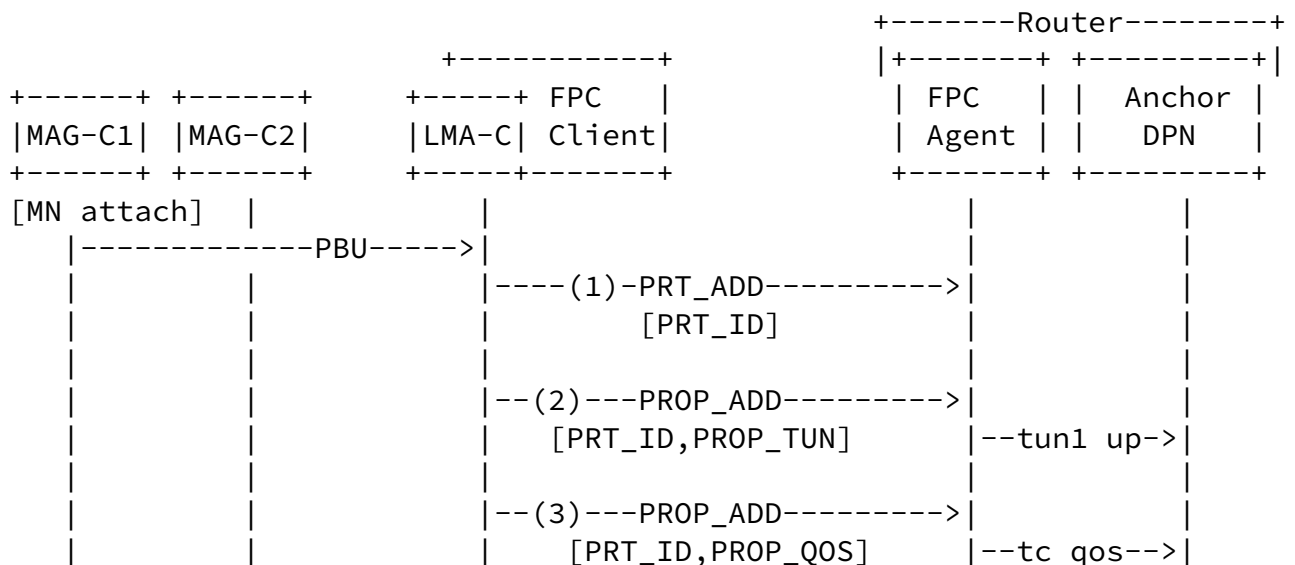

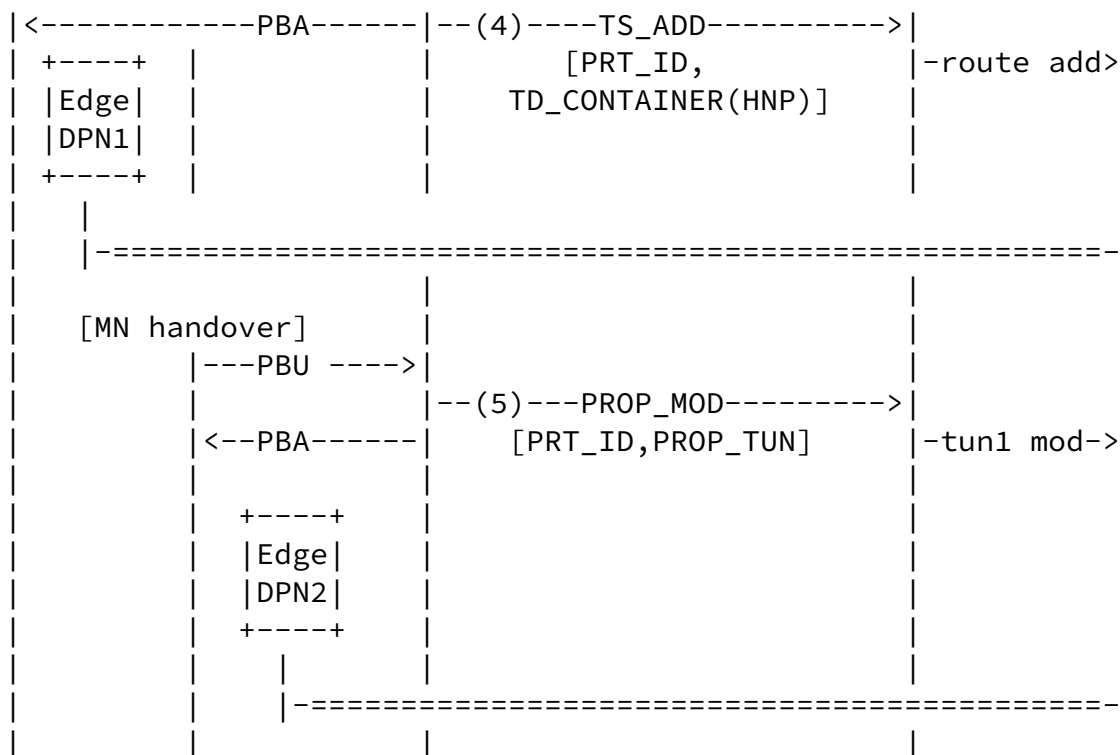

Figure 14: Exemplary Message Sequence (focus on FPC reference point)

After reception of the Proxy Binding Update (PBU) at the LMA Control-Plane function (LMA_C), the LMA-C selects a suitable DPN, which serves as Data-Plane anchor to the mobile node's (MN) traffic. The

LMA-C adds a new logical port to the DPN to treat the MN's traffic (1) and includes a Port Identifier (PRT_ID) to the PRT_ADD command. The LMA-C identifies the selected Anchor DPN by including the associated DPN identifier.

Subsequently, the LMA-C adds properties to the new port. One property is added (2) to specify the forwarding tunnel type and endpoints (Anchor DPN, Edge DPN1). Another property is added (3) to specify the QoS differentiation, which the MN's traffic should experience. At reception of the properties, the FPC Agent utilizes local configuration commands to create the tunnel (tun1) as well as the traffic control (tc) to enable QoS differentiation. After configuration of port properties have been completed, the LMA binds the traffic description for the MN's traffic to the port by sending a

TS_CONTAINER to the Agent and identifying the MN's Home Network Prefix (HNP) in the traffic descriptor. At the reception of the traffic descriptor, the Agent applies a new route to forward all traffic destined to the MN's HNP to the configured tunnel interface (tun1).

During handover, the LMA-C receives an updating PBU from the handover target MAG-C2. The PBU refers to a new Data-Plane node (Edge DPN2) to represent the new tunnel endpoint. The LMA-C sends a PROP_MOD message (5) to the Agent to modify the existing tunnel property of the existing port and to update the tunnel endpoint from Edge DPN1 to Edge DPN2. Upon reception of the PROP_MOD message, the Agent applies updated tunnel property to the local configuration.

To reduce the number of protocol handshakes between the LMA-C and the DPN, the LMA-C can append properties (PROP_TUN, PROP_QOS) and traffic descriptor attributes to the PRT_ADD message, as illustrated in Figure 15.

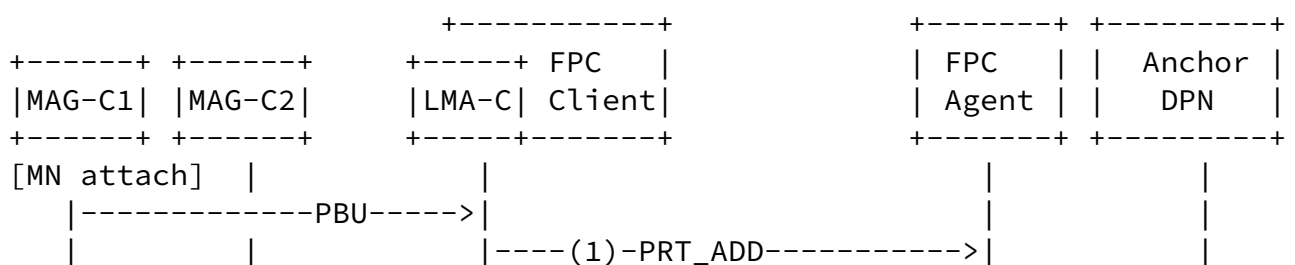

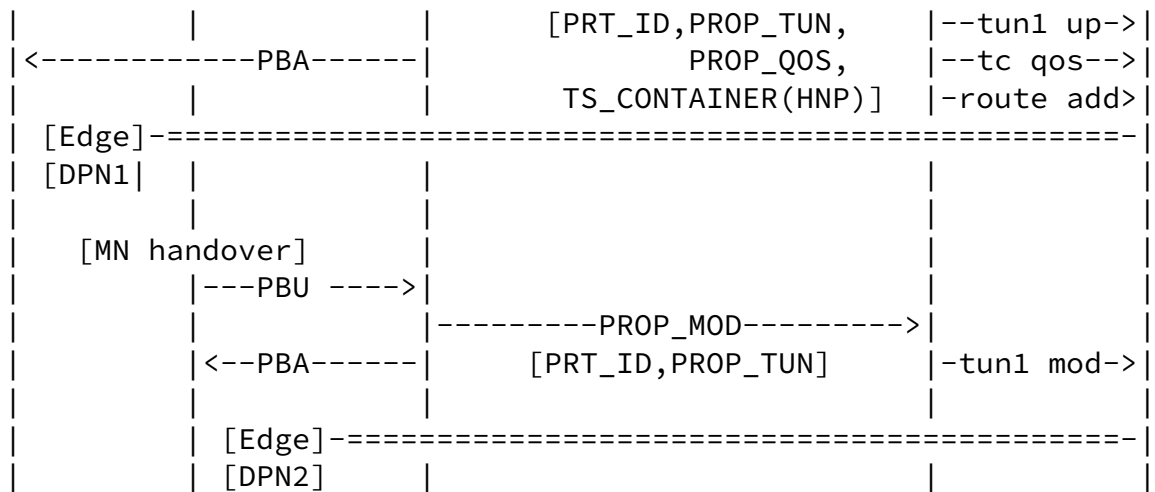

Figure 15: Example: Sequence for Message Aggregation (focus on FPC reference point)

5. Protocol to support Model II

5.1. Protocol Attributes

Attribute	Format	Description
IP Tunnel Attributes		
TUN_SRC_IP_ADDR	[IP address]	Tunnel Source IP
TUN_DST_IP_ADDR	[IP address]	Tunnel Destination IP
TUN_ENCAP_TYPE	[ENCAP_GRE, ENACP_UDP, ENCAP_IP]	Encapsulation Type
TUN_TYPE_UDP	[SRC_PRT, DST_PRT]	UDP Direction - Source or Destination
TUN_TYPE_GRE	[UPLINK_GRE_KEY, DOWNLINK_GRE_KEY]	GRE Tunnel Type

TUN_IF_MTU	[MTU]	Tunnel Interface MTU
TUN_PAYLOAD_TYPE	[PAYLOAD_IPV4, PAYLOAD_IPV6, PAYLOAD_DUAL]	Tunnel Payload Type
TUN_VENDOR_SPEC_PARAM	[OPAQUE]	Tunnel Vendor Specific Parameters
Route Management Attributes		
INPUT_IF	[IF_INDEX]	Input Interface
OUTPUT_IF	[IF_INDEX]	Output Interface
NEXT_HOP_IP_GW_ADDR	[IP address]	Next Hop IP Gateway Address
TRAFFIC_SELECTOR_ACL	TBD	
DST_IP_SUBNET	[IP prefix]	Destination IP Subnet
DST_IP_SUBNET_MASK	[IP prefix]	Destination IP Subnet Mask
QoS Attributes		
AMBR	[Unsigned Integer (32 bit)]	Aggregate Maximum Bitrate
GBR	[Unsigned Integer (32 bit)]	Guaranteed Bitrate
TCLASS	[Unsigned Integer (32 bit)]	Traffic Class
TFT	TBD	Traffic Flow Template
Optional Attributes		
NSH_HEADER	[Service Path Id]	NSH Header

```
|
|                                     | Service Index, TFT] |
+-----+-----+-----+-----+-----+-----+-----+-----+-----+-----+
```

Figure 16: Model II Protocol Attributes: Traffic Treatment

Attribute	Format	Description
Identifier		
TUNNEL_IF_ID	[IF_INDEX]	Tunnel Interface Identifier
VRF_ID	[Unsigned INT]	VRF Identifier
PBR_ID	[Unsigned INT]	Policy Based Routing Identifier
CTRL_PLANE_ID	IP address	Control-Plane Identifier
CONTEXT_ID	TBD	Context Identifier
QOS_SERVICE_ID	[Unsigned INT]	QoS Service Identifier
SESSION_ID	[Unsigned INT]	Session Identifier
ROUTE_ID	[Unsigned INT]	Route Identifier
Optional Identifiers		
SERVICE_PATH_ID	[24-bit identifier]	Service Path Identifier

Figure 17: Model II Protocol Attributes: Identifiers

5.2. Protocol Messages and Semantics

Message	Description
Tunnel Interface Management	

CREATE_TUNNEL_IF	Create a Tunnel Interface
DELETE_TUNNEL_IF	Delete a Tunnel Interface

UPDATE_TUNNEL_PARAMETER	Update a parameter of the specified tunnel
QUERY_TUNNEL_IF	Request Tunnel Interface information
Policy Route Management	
CREATE_POLICY_ROUTE	Create a Policy-based Route
DELETE_POLICY_ROUTE	Deletes a Policy-based Route
ADD_TRAFFIC_SELECTOR	Adds a Traffic Selector to a Policy-based Route
DELETE_TRAFFIC_SELECTOR	Removes a Traffic Selector from a Policy-based Route
QUERY_POLICY_ROUTE	Request Policy Route information
IP Route Management	
CREATE_IP_ROUTE	Create an IP Route
DELETE_IP_ROUTE	Delete an IP Route
QUERY_IP_ROUTE	Request IP Route information
IP QoS Management	
ALLOCATE_QOS_RESOURCES	Allocates QoS Resources, e.g. AMBR, to the specified Session / Context
DEALLOCATE_QOS_RESOURCES	Removes applies QoS Resources from the specified Session / Context
Optional Management	

ADD_NS_H_HEADER	Add NSH Header for the classified IP flows
DELETE_NS_H_HEADER	Remove NSH Header for the classified IP flows

Figure 18: Model II Protocol Messages

5.3. Protocol Operation

The following list comprises a description of each message's semantic.

- o CREATE_TUNNEL_IF - Message can include TUN_SRC_IP_ADDR, TUN_DST_IP_ADDR, TUN_ENCAP_TYPE, TUN_IF_ID, TUN_TYPE_UDP, TUN_TYPE_GRE, TUN_IF_MTU, TUN_PAYLOAD_TYPE, TUN_VENDOR_SPEC_PARAM, VRF_ID, CTRL_PLANE_ID, CONTEXT_ID.
- o DELETE_TUNNEL_IF - Message can include TUN_SRC_IP_ADDR, TUN_DST_IP_ADDR, TUN_ENCAP_TYPE, TUN_IF_ID, CTRL_PLANE_ID, CONTEXT_ID.
- o UPDATE_TUNNEL_PARAMETER - Message can include TUN_SRC_IP_ADDR, TUN_DST_IP_ADDR, TUN_ENCAP_TYPE, TUN_IF_ID, TUN_IF_MTU, TUN_PAYLOAD_TYPE, TUN_VENDOR_SPEC_PARAM, CTRL_PLANE_ID, CONTEXT_ID.
- o QUERY_TUNNEL_IF -
- o CREATE_POLICY_ROUTE - Message can include INPUT_IF, OUTPUT_IF, NEXT_HOP_IP_GW_ADDR, VRF_ID, PBR_ID, CTRL_PLANE_ID, CONTEXT_ID.
- o DELETE_POLICY_ROUTE - Message can include PBR_ID, CTRL_PLANE_ID, CONTEXT_ID.
- o ADD_TRAFFIC_SELECTOR - Message can include TRAFFIC_SELECTOR_ACL, PBR_ID, CTRL_PLANE_ID, CONTEXT_ID.

- o DELETE_TRAFFIC_SELECTOR - Message can include TRAFFIC_SELECTOR_ACL, PBR_ID, CTRL_PLANE_ID, CONTEXT_ID.
- o QUERY_POLICY_ROUTE -
- o CREATE_IP_ROUTE - Message can include DST_IP_SUBNET, DST_IP_SUBNET_MASK, OUTPUT_IF, VRF_ID, ROUTE_ID, CTRL_PLANE_ID, CONTEXT_ID.
- o DELETE_IP_ROUTE - Message can include ROUTE_ID, CTRL_PLANE_ID, CONTEXT_ID.
- o QUERY_IP_ROUTE -
- o ALLOCATE_QOS_RESOURCES - Message can include AMBR, GBR, TCLASS, TFT, QOS_SERVICE_ID, CONTEXT_ID.

- o DEALLOCATE_QOS_RESOURCES - Message can include Session_ID, QOS_SERVICE_ID, CONTEXT_ID.
- o ADD_NSH_HEADER - Message can include SERVICE_PATH_ID, SERVICE_INDEX, TFT
- o DELETE_NSH_HEADER - Message can include SERVICE_PATH_ID, SERVICE_INDEX, TFT

6. YANG Data Model for the FPC protocol

These modules define Model I YANG definitions. Four modules are defined:

- o ietf-dmm-fpcp-base (fpcp-base) - Defines the base model for Model I FPC as defined in this document
- o ietf-pmip-qos (pmip-qos) - Defines proxy mobile IPv6 QoS parameters per [RFC 7222](#)
- o ietf-traffic-selectors-types (traffic-selectors) - Defines Traffic Selectors per [RFC 6088](#)

- o ietf-dmm-fpcp-pmip - Augments fpcp-base to include PMIP Traffic Selectors as a Traffic Descriptor subtype and pmip-qos QoS parameters, where applicable, as properties.

Note (2016-03-21): The YANG Data Model does not yet adopt all extensions per this version of the draft and will be updated shortly after the IETF95 meeting.

[6.1.](#) FPC Base

[6.1.1.](#) FPC Base YANG Model

```
module ietf-dmm-fpcp-base {
  namespace "urn:ietf:params:xml:ns:yang:ietf-dmm-fpcp-base";
  prefix fpcp-base;

  import ietf-inet-types { prefix inet; }

  organization "IETF DMM Working Group";
  contact "Satoru Matsushima <satoru.matsushima@g.softbank.co.jp>";

  description
    "This module contains YANG definition for
    Forwarding Policy Configuration Protocol.(FPCP)";
```

```
revision 2016-01-18 {
  description "Changes based on -01 version of FPCP draft.";
  reference "draft-ietf-dmm-fpc-cpdp-01";
}

typedef fpcp-name-type {
  type string;
  description "FPCP common name type";
}

typedef fpcp-carrier-id {
  type uint16;
  description "Carrier-ID";
}
```

```

typedef fpcp-network-id {
    type uint16;
    description "Carrier-ID";
}

typedef fpcp-client-id {
    type uint32;
    description "Client-ID";
}

typedef fpcp-agent-id {
    type uint32;
    description "Agent-ID";
}

typedef fpcp-dpn-id {
    type uint32;
    description "Carrier-ID";
}

typedef fpcp-port-id {
    type uint32;
    description "PRT_ID";
}

typedef fpcp-property-id {
    type uint8;
    description "PRT_PROP_ID";
}

typedef fpcp-rule-id {
    type uint8;
    description "PRT_RULE_ID";
}

```

```

}

typedef fpcp-qos-class-identifier {
    type uint8 {
        range "1..9";
    }
    description "QCI";
}

```



```

typedef fpcp-qos-bandwidth {
    type uint32;
    description "Bandwith value in bit per second.";
}

identity tunnel-type {
    description
    "Base identity from which specific use of
    tunnels are derived.";
}

identity fpcp-tunnel-type {
    base "tunnel-type";
    description
    "Base identity from which specific tunnel
    types in FPCP uses are derived.";
}

identity ip-in-ip {
    base "fpcp-tunnel-type";
    description "IP-in-IP tunnel";
}

identity gtp {
    base "fpcp-tunnel-type";
    description "GTP-U tunnel";
}

identity gre {
    base "fpcp-tunnel-type";
    description "GRE tunnel";
}

identity service-function {
    description
    "Base identity from which specific
    service function types are derived.";
}

```

```

identity ip-protocol {

```

```

    description
    "Base identity from which specific
    IP protocol types are derived.";
}

identity property-type {
    description
    "Base identity of property";
}

identity property-qos {
    base "property-type";
    description
    "QoS property";
}

identity property-endpoint {
    base "property-type";
    description
    "Endpoint property";
}

identity property-type-endpoint {
    base "property-type";
    description
    "Endpoint property";
}

identity qos-type {
    description
    "Base identity from which specific
    uses of QoS types are derived.";
}

identity fpcp-qos-type {
    base "qos-type";
    description
    "Base identity from which specific
    QoS types in FPCP uses are derived.";
}

identity fpcp-qos-type-gbr {
    base "fpcp-qos-type";
    description
    "A QoS Type for Guaranteed Bit Rate (GBR).";
}

```

```
identity fpcp-qos-type-mbr {
    base "fpcp-qos-type";
    description
        "A QoS Type for Maximum Bit Rate (MBR).";
}

identity fpcp-qos-index-type {
    base "qos-type";
}

identity fpcp-qos-index {
    base "fpcp-qos-index-type";
}

identity traffic-descriptor-type {
}

identity fpcp-traffic-descriptor {
    base "traffic-descriptor-type";
}

grouping carrier {
    description "Identify FPCP Carrier";
    leaf carrier-id {
        type fpcp-carrier-id;
        mandatory true;
        description "Carrier ID";
    }
}

grouping agent {
    description "AGT_ID to identify FPCP Agent";
    leaf agent-id {
        type fpcp-agent-id;
        description "Agent ID";
    }
}

grouping client {
    description "CLI_ID to identify FPCP Client";
    leaf client-id {
        type fpcp-client-id;
        description "Client ID";
    }
}
```

```
grouping network {
  description "Identify FPCP Network";
  leaf network-id {
    type fpcp-network-id;
    description "Network ID";
  }
}

grouping dpn {
  description "Identify FPCP Data-Plane Node";
  leaf dpn-id {
    type fpcp-dpn-id;
    description "DPN ID";
  }
}

grouping port {
  description "Identify FPCP Port";
  leaf port-id {
    type fpcp-port-id;
    description "Port-ID";
  }
}

grouping property {
  description "Identify FPCP Property";
  leaf property-id {
    type fpcp-property-id;
    description "Property-ID";
  }
}

grouping rule {
  description "Identify FPCP Rule";
  leaf rule-id {
    type fpcp-rule-id;
    description "Rule-ID";
  }
}
```

```

grouping fpcp-carrier {
    description "Define FPCP network";
    uses carrier;
    uses agent;
    list client {
        key client-id;
        description "List of FPCP Clients";
        leaf name {

```

```

        type fpcp-name-type;
        description "Client Name";
    }
    uses client;
}
list dpn {
    key dpn-id;
    description "List of FPCP DPNs";
    leaf name {
        type fpcp-name-type;
        description "DPN Name";
    }
    uses dpn;
}
}

grouping dpn-set {
    description "DPNs which consist a DPN set.";
    leaf name {
        type fpcp-name-type;
        description "DPN set name";
    }
    leaf network {
        type leafref {
            path "/fpcp-carriers/carrier/network/network-id";
        }
        description "Network-ID which a DPN-set is belonging to.";
    }
    leaf role {
        type enumeration {
            enum anchor-l3 {
                description "";

```

```

    }
    enum anchor-l2 {
        description "";
    }
    enum access {
        description "";
    }
}
description "Define DPNs role in data-plane.";
}
list endpoint-dp {
    key local-address;
    description "List of data-plane endpoint properties of a
                set of DPNs.";
    leaf local-address {
        type inet:ip-address;
    }
}

```

```

    description "";
}
leaf remote-dpn {
    type leafref {
        path "/fpcp-carriers/carrier/dpn-group/name";
    }
    description "";
}
leaf default-tunnel-type {
    type identityref {
        base "fpcp-tunnel-type";
    }
    description "Tunnel Type";
}
}
grouping dpn-set {
    description "DPNs which consist a DPN set.";
    leaf name {
        type fpcp-name-type;
        description "DPN set name";
    }
}
leaf network {
    type leafref {
        path "/fpcp-carriers/carrier/network/network-id";
    }
}
}
}

```

```

        description "Network-ID which a DPN-set is belonging to.";
    }
    leaf role {
        type enumeration {
            enum anchor-l3 {
                description "";
            }
            enum anchor-l2 {
                description "";
            }
            enum access {
                description "";
            }
        }
        description "Define DPNs role in data-plane.";
    }
    list endpoint-dp {
        key local-address;
        description "List of data-plane endpoint properties of a
            set of DPNs.";
        leaf local-address {
            type inet:ip-address;
            description "";
        }
    }

```

```

    }
    leaf remote-dpn {
        type leafref {
            path "/fpcp-carriers/carrier/dpn-group/name";
        }
        description "";
    }
    leaf default-tunnel-type {
        type identityref {
            base "fpcp-tunnel-type";
        }
        description "Tunnel Type";
    }
}
list dpn {
    key dpn-id;
    uses dpn;
    description "DPN list in a DPN set";
}

```

```

    }
}

grouping tunnel-endpoints {
    description
    "PROP_TUN property as a set of tunnel endpoints";
    leaf tunnel-type {
        type identityref {
            base "fpcp-tunnel-type";
        }
        description "Tunnel Type";
    }
    leaf remote-address {
        type inet:ip-address;
        description "Remote endpoint";
    }
    leaf local-address {
        type inet:ip-address;
        description "Local endpoint";
    }
}

```

```

grouping gtp-attributes {
    description
    "GTP_CONF as GTP tunnel specific attributes";
    leaf remote-teid {
        type uint32;
        description "TEID of remote-endpoint";
    }
    leaf local-teid {

```

```

        type uint32;
        description "TEID of local-endpoint";
    }
}
grouping gre-attributes {
    description
    "GRE_CONF as GRE tunnel specific attribute";
    leaf key {
        type uint32;
        description "GRE_KEY";
    }
}

```



```

}

grouping rewriting-properties {
  description
    "PROP_REWR. TBD for which type of rewriting functions
    need to be defined";
  leaf type {
    type identityref {
      base service-function;
    }
    description "The type of service-function";
  }
}

grouping fpcp-qosattribute {
  leaf qci {
    type fpcp-qos-class-identifier;
  }
  leaf attributetype {
    type identityref {
      base fpcp-qos-type;
    }
    description "the attribute type";
  }
  leaf bandwidth {
    type fpcp-qos-bandwidth;
  }
}

grouping fpcp-qos-property {
  description "PROP_QOS";
  leaf name {
    type fpcp-name-type;
  }
  leaf qos-index-type {
    type identityref {
      base "fpcp-qos-index-type";
    }
  }
}

```

```

}
}
choice index-type {
  case qci {

```

```

        when "../qos-index-type = 'fpcp-qos-index'";
        container uplink {
            uses fpcp-qosattribute;
        }
        container downlink {
            uses fpcp-qosattribute;
        }
    }
}

```

```

grouping traffic-descriptor {
    description
    "Traffic descriptor group collects parameters to
    identify target traffic flow.";

    leaf destination-ip {
        type inet:ip-prefix;
        description "Rule of destination IP";
    }
    leaf source-ip {
        type inet:ip-prefix;
        description "Rule of source IP";
    }
}

```

```

grouping fpcp-traffic-descriptor {
    leaf name {
        type fpcp-name-type;
    }
    leaf traffic-descriptor-type {
        type identityref {
            base "traffic-descriptor-type";
        }
    }
}

choice descriptor-type {
    case fpcp-traffic-descriptor {
        when "../descriptor-type = 'fpcp-traffic-descriptor'";
        uses traffic-descriptor;
    }
}

```

```
}

grouping fpcp-forwarding-rule {
    uses rule;
    uses fpcp-traffic-descriptor;
}

grouping fpcp-port-properties {
    description
    "A set of port property attributes";

    uses property;
    list attached-dpns {
        key name;
        leaf name {
            type fpcp-name-type;
            description "DPN group name of which port attached.";
        }
        description "Port attached DPN group list.";
    }
    container endpoints {
        description "Tunnel Endpoint";
        uses tunnel-endpoints;
        choice tunnel {
            description "Tunnel-Type";
            case gtp-u {
                when "tunnel-type = 'gtp'" {
                    description "In case of GTP-U is tunnel-type";
                }
                uses gtp-attributes;
            }
            case gre {
                when "tunnel-type = 'gre'" {
                    description "In case of GRE is tunnel-type";
                }
                uses gre-attributes;
            }
        }
    }
    container qos {
        description "QoS Type";
        uses fpcp-qos-property;
        list port-in-aggregated-bandwidth {
            key port-id;
            uses port;
        }
    }
}
```

```
container rewriting {
```

```
        description "Rewriting function";
        uses rewriting-properties;
    }
}

grouping port-field {
    description "Definition of attributes of port field";
    uses port;
    uses carrier;
    uses network;
}

// Container for configurations sets.

container fpcp-carriers {
    description "Attributes set of FPCP network";

    list carrier {
        key carrier-id;
        description "List of carriers";
        leaf name {
            type fpcp-name-type;
            description "FPCP Carrier name";
        }
        uses fpcp-carrier;
        list network {
            key network-id;
            description "List of networks in a carrier.";
            leaf name {
                type fpcp-name-type;
                description "Define visible name of a network.";
            }
            uses network;
        }
        list dpn-group {
            key name;
            description "List of DPN groups in a carrier.";
            uses dpn-set;
        }
        list qos-profile {
```

```
        key name;
        uses fpcp-qos-property;
    }
    list traffic-descriptor {
        key name;
        uses fpcp-traffic-descriptor;
    }
}
```

```
    }

    // Port Entries

    container port-entries {
        config false;
        description
        "This container binds set of traffic-descriptor and
        port properties to a port and lists them as a port entry.";

        list port-entry {
            key port-id;
            description "List of port entries";
            uses port-field;

            list property {
                key property-id;
                description "Attributes set of properties";
                uses fpcp-port-properties;
            }

            list forwarding-rule {
                key rule-id;
                description "Rule and traffic-descriptor";
                uses fpcp-forwarding-rule;
            }
        }
    }

    // PRT_ADD

    rpc port_add {
```

```

description "PRT_ADD";
input {
    list adding-port {
        description "Ports that are added to an agent";
        uses port-field;
        list forwarding-rule {
            key rule-id;
            description "Rule and traffic-descriptor";
            uses fpcp-forwarding-rule;
        }
        list property {
            key property-id;
            description "Attributes set of properties";
            uses fpcp-port-properties;
        }
    }
}

```

```

    }
}

// PRT_DEL

rpc port_delete {
    description "PRT_DEL";
    input {
        list deleting-port {
            description "Ports that are deleted from an agent";
            uses port-field;
        }
    }
}

// PROP_ADD

rpc port_property_add {
    description "PROP_ADD";
    input {
        list adding-property {
            description "Properties that are added to an agent";
            uses port-field;
        }
    }
}

```

```

        list property {
            key property-id;
            description "Attributes set of properties";
            uses fpcp-port-properties;
        }
    }
}

```

// PROP_MOD

```

rpc port_property_modify {
    description "PROP_MOD";
    input {
        list modifying-property {
            description
            "Properties that are modified in an agent";
            uses port-field;

            list property {
                key property-id;
                description "Attributes set of properties";
            }
        }
    }
}

```

```

        }
    }
}
    }
}

```

// PROP_DEL

```

rpc port_property_delete {
    description "PROP_DEL";
    input {
        list deleting-property {
            description
            "Target port/property-id of deleting properties";
            uses port-field;

            leaf property-id {
                type fpcp-property-id;
            }
        }
    }
}

```

```

        mandatory true;
        description "Property ID";
    }
}
}

// RULE_ADD

rpc rule_add {
    description
    "TBD for input parameters of which RULE_ADD includes
    but now just traffic-descriptor.";
    input {
        list adding-rule {
            description "Rules that are added to an agent";
            uses port-field;

            list forwarding-rule {
                description "Added rule";
                uses fpcp-forwarding-rule;
            }
        }
    }
}

// RULE_MOD

rpc rule_modify {

```

```

    description
    "TBD for input parameters of which RULE_MOD includes
    but now just traffic-descriptor.";
    input {
        list modifying-rule {
            description "Rules that are modified in an agent";
            uses port-field;

            list forwarding-rule {
                description "Modified rule";
                uses fpcp-forwarding-rule;
            }
        }
    }

```



```

    }
  }
}

// RULE_DEL

rpc rule_delete {
  description
  "TBD for input parameters of which RULE_DEL includes
  but now just traffic-descriptor.";
  input {
    list deleting-rule {
      description "Rules that are deleted from an agent";
      uses port-field;

      list target-rule {
        description "Deleting rules";
        leaf target-rule-id {
          type fpcp-rule-id;
          mandatory true;
          description "Rule ID";
        }
      }
    }
  }
}

```

```
// EVENT_REG
```

```

rpc event_register {
  description
  "TBD for registered parameters included in EVENT_REG.";
}

```

```
// PROBE
```

```

rpc probe {
  description
  "TBD for retrieved parameters included in PROBE.";
}

```

```

// NOTIFY

notification notify {
    description
    "TBD for which status and event are reported to client.";
}

}

```

Figure 19: FPC YANG base

6.1.2. FPC Base tree

```

module: ietf-dmm-fpcp-base
+--rw fpcp-carriers
|  +--rw carrier* [carrier-id]
|  |  +--rw name?          fpcp-name-type
|  |  +--rw carrier-id    fpcp-carrier-id
|  |  +--rw agent-id?     fpcp-agent-id
|  |  +--rw client* [client-id]
|  |  |  +--rw name?      fpcp-name-type
|  |  |  +--rw client-id  fpcp-client-id
|  |  +--rw dpn* [dpn-id]
|  |  |  +--rw name?      fpcp-name-type
|  |  |  +--rw dpn-id    fpcp-dpn-id
|  |  +--rw network* [network-id]
|  |  |  +--rw name?      fpcp-name-type
|  |  |  +--rw network-id fpcp-network-id
|  |  +--rw dpn-group* [name]
|  |  |  +--rw name        fpcp-name-type
|  |  |  +--rw network?   -> /fpcp-carriers/carrier/network/network-id
|  |  |  +--rw role?      enumeration
|  |  |  +--rw endpoint-dp* [local-address]
|  |  |  |  +--rw local-address    inet:ip-address
|  |  |  |  +--rw remote-dpn? -> /fpcp-carriers/carrier/dpn-group/name
|  |  |  |  +--rw default-tunnel-type? identityref
|  |  |  +--rw dpn* [dpn-id]
|  |  |  |  +--rw dpn-id    fpcp-dpn-id
|  |  +--rw qos-profile* [name]
|  |  |  +--rw name        fpcp-name-type
|  |  |  +--rw qos-index-type? identityref
|  |  |  +--rw (index-type)?
|  |  |  |  +--:(qci)

```

```

|       |
|       |         +--rw uplink
|       |         |   +--rw qci?                   fpcp-qos-class-identifier
|       |         |   +--rw attributetype?        identityref
|       |         |   +--rw bandwidth?           fpcp-qos-bandwidth
|       |         +--rw downlink
|       |         |   +--rw qci?                   fpcp-qos-class-identifier
|       |         |   +--rw attributetype?        identityref
|       |         |   +--rw bandwidth?           fpcp-qos-bandwidth
|       +--rw traffic-descriptor* [name]
|       |   +--rw name                             fpcp-name-type
|       |   +--rw traffic-descriptor-type?        identityref
|       |   +--rw (descriptor-type)?
|       |       +--:(fpcp-traffic-descriptor)
|       |         +--rw destination-ip?           inet:ip-prefix
|       |         +--rw source-ip?               inet:ip-prefix
+--ro port-entries
+--ro port-entry* [port-id]
+--ro port-id              fpcp-port-id
+--ro carrier-id           fpcp-carrier-id
+--ro network-id?         fpcp-network-id
+--ro property* [property-id]
|   +--ro property-id      fpcp-property-id
|   +--ro attached-dpns* [name]
|   |   +--ro name         fpcp-name-type
|   +--ro endpoints
|   |   +--ro tunnel-type?  identityref
|   |   +--ro remote-address?  inet:ip-address
|   |   +--ro local-address?  inet:ip-address
|   |   +--ro (tunnel)?
|   |       +--:(gtp-u)
|   |         +--ro remote-teid?    uint32
|   |         +--ro local-teid?    uint32
|   |       +--:(gre)
|   |         +--ro key?           uint32
|   +--ro qos
|   |   +--ro name?              fpcp-name-type
|   |   +--ro qos-index-type?    identityref
|   |   +--ro (index-type)?
|   |       +--:(qci)
|   |         +--ro uplink
|   |         |   +--ro qci?                   fpcp-qos-class-identifier
|   |         |   +--ro attributetype?        identityref
|   |         |   +--ro bandwidth?           fpcp-qos-bandwidth
|   |         +--ro downlink
|   |         |   +--ro qci?                   fpcp-qos-class-identifier
|   |         |   +--ro attributetype?        identityref
|   |         |   +--ro bandwidth?           fpcp-qos-bandwidth
|   +--ro port-in-aggregated-bandwidth* [port-id]

```

Internet-Draft

DMM FPC Protocol

March 2016

```

| |      +---ro port-id      fpcp-port-id
| +---ro rewriting
|      +---ro type?      identityref
+---ro forwarding-rule* [rule-id]
      +---ro rule-id              fpcp-rule-id
      +---ro name?                fpcp-name-type
      +---ro traffic-discriptor-type? identityref
      +---ro (descriptor-type)?
          +---:(fpcp-traffic-descriptor)
              +---ro destination-ip?      inet:ip-prefix
              +---ro source-ip?          inet:ip-prefix

```

rpcs:

```

+---x port_add
| +---w input
|   +---w adding-port*
|     +---w port-id?          fpcp-port-id
|     +---w carrier-id       fpcp-carrier-id
|     +---w network-id?     fpcp-network-id
|     +---w forwarding-rule* [rule-id]
|       | +---w rule-id              fpcp-rule-id
|       | +---w name?                fpcp-name-type
|       | +---w traffic-discriptor-type? identityref
|       | +---w (descriptor-type)?
|       |   +---:(fpcp-traffic-descriptor)
|       |     +---w destination-ip?      inet:ip-prefix
|       |     +---w source-ip?          inet:ip-prefix
|     +---w property* [property-id]
|       +---w property-id      fpcp-property-id
|       +---w attached-dpns* [name]
|         | +---w name      fpcp-name-type
|       +---w endpoints
|         | +---w tunnel-type?      identityref
|         | +---w remote-address?   inet:ip-address
|         | +---w local-address?    inet:ip-address
|         | +---w (tunnel)?
|         |   +---:(gtp-u)
|         |     | +---w remote-teid?   uint32
|         |     | +---w local-teid?    uint32
|         |     +---:(gre)
|         |       +---w key?          uint32
|       +---w qos

```

```

|         | +---w name?                fpcp-name-type
|         | +---w qos-index-type?      identityref
|         | +---w (index-type)?
|         | |   +---:(qci)
|         | |       +---w uplink
|         | |       |   +---w qci?        fpcp-qos-class-identifier

```

```

|         | |         | +---w attributetype?  identityref
|         | |         | +---w bandwidth?    fpcp-qos-bandwidth
|         | |         | +---w downlink
|         | |         | +---w qci?          fpcp-qos-class-identifier
|         | |         | +---w attributetype?  identityref
|         | |         | +---w bandwidth?    fpcp-qos-bandwidth
|         | |         | +---w port-in-aggregated-bandwidth* [port-id]
|         | |         | +---w port-id      fpcp-port-id
|         | +---w rewriting
|         | +---w type?    identityref
+---x port_delete
| +---w input
|   +---w deleting-port*
|     +---w port-id?      fpcp-port-id
|     +---w carrier-id   fpcp-carrier-id
|     +---w network-id?  fpcp-network-id
+---x port_property_add
| +---w input
|   +---w adding-property*
|     +---w port-id?      fpcp-port-id
|     +---w carrier-id   fpcp-carrier-id
|     +---w network-id?  fpcp-network-id
|     +---w property* [property-id]
|       +---w property-id    fpcp-property-id
|       +---w attached-dpns* [name]
|         | +---w name      fpcp-name-type
|       +---w endpoints
|         | +---w tunnel-type?    identityref
|         | +---w remote-address?  inet:ip-address
|         | +---w local-address?   inet:ip-address
|         | +---w (tunnel)?
|         |   +---:(gtp-u)
|         |   |   +---w remote-teid?    uint32
|         |   |   +---w local-teid?     uint32
|         |   +---:(gre)

```

```

|         |         +---w key?                uint32
+---w qos
|         |         +---w name?                fpcp-name-type
|         |         +---w qos-index-type?      identityref
|         |         +---w (index-type)?
|         |         |         +--:(qci)
|         |         |         +---w uplink
|         |         |         |         +---w qci?                fpcp-qos-class-identifier
|         |         |         |         +---w attributetype? identityref
|         |         |         |         +---w bandwidth? fpcp-qos-bandwidth
|         |         |         +---w downlink
|         |         |         +---w qci?                fpcp-qos-class-identifier
|         |         +---w attributetype? identityref

```

```

|         |         |         +---w bandwidth? fpcp-qos-bandwidth
|         |         |         +---w port-in-aggregated-bandwidth* [port-id]
|         |         |         +---w port-id    fpcp-port-id
|         |         +---w rewriting
|         |         +---w type?    identityref
+---x port_property_modify
|         +---w input
|         +---w modifying-property*
|         +---w port-id?          fpcp-port-id
|         +---w carrier-id       fpcp-carrier-id
|         +---w network-id?     fpcp-network-id
|         +---w property* [property-id]
|         +---w property-id      fpcp-property-id
|         +---w attached-dpns* [name]
|         |         +---w name    fpcp-name-type
|         +---w endpoints
|         |         +---w tunnel-type?    identityref
|         |         +---w remote-address? inet:ip-address
|         |         +---w local-address?  inet:ip-address
|         |         +---w (tunnel)?
|         |         |         +--:(gtp-u)
|         |         |         |         +---w remote-teid?    uint32
|         |         |         |         +---w local-teid?     uint32
|         |         |         +--:(gre)
|         |         +---w key?        uint32
+---w qos
|         |         +---w name?                fpcp-name-type
|         |         +---w qos-index-type?      identityref

```

```

|         | +---w (index-type)?
|         | |   +---:(qci)
|         | |   +---w uplink
|         | |   |   +---w qci?           fpcp-qos-class-identifier
|         | |   |   +---w attributetype?  identityref
|         | |   |   +---w bandwidth?     fpcp-qos-bandwidth
|         | |   +---w downlink
|         | |   |   +---w qci?           fpcp-qos-class-identifier
|         | |   |   +---w attributetype?  identityref
|         | |   |   +---w bandwidth?     fpcp-qos-bandwidth
|         | |   +---w port-in-aggregated-bandwidth* [port-id]
|         | |   +---w port-id           fpcp-port-id
|         +---w rewriting
|         |   +---w type?           identityref
+---x port_property_delete
|   +---w input
|     +---w deleting-property*
|       +---w port-id?           fpcp-port-id
|       +---w carrier-id         fpcp-carrier-id
|       +---w network-id?       fpcp-network-id

```

```

|         +---w property-id       fpcp-property-id
+---x rule_add
|   +---w input
|     +---w adding-rule*
|       +---w port-id?           fpcp-port-id
|       +---w carrier-id         fpcp-carrier-id
|       +---w network-id?       fpcp-network-id
|       +---w forwarding-rule*
|         +---w rule-id?         fpcp-rule-id
|         +---w name?           fpcp-name-type
|         +---w traffic-descriptor-type?  identityref
|         +---w (descriptor-type)?
|           +---:(fpcp-traffic-descriptor)
|             +---w destination-ip?       inet:ip-prefix
|             +---w source-ip?           inet:ip-prefix
+---x rule_modify
|   +---w input
|     +---w modifying-rule*
|       +---w port-id?           fpcp-port-id
|       +---w carrier-id         fpcp-carrier-id
|       +---w network-id?       fpcp-network-id

```

```

|         +---w forwarding-rule*
|         +---w rule-id?           fpcp-rule-id
|         +---w name?             fpcp-name-type
|         +---w traffic-descriptor-type? identityref
|         +---w (descriptor-type)?
|             +--:(fpcp-traffic-descriptor)
|                 +---w destination-ip?       inet:ip-prefix
|                 +---w source-ip?           inet:ip-prefix
+---x rule_delete
|   +---w input
|     +---w deleting-rule*
|       +---w port-id?           fpcp-port-id
|       +---w carrier-id        fpcp-carrier-id
|       +---w network-id?       fpcp-network-id
|       +---w target-rule*
|         +---w target-rule-id   fpcp-rule-id
+---x event_register
+---x probe
notifications:
+---n notify

```

Figure 20: FPC base tree

[6.2.](#) FPC PMIP

[6.2.1.](#) FPC PMIP YANG Model

```

module ietf-dmm-fpcp-pmip {
  namespace "urn:ietf:params:xml:ns:yang:ietf-dmm-fpcp-pmip";
  prefix fpcp-pmip;

  import ietf-inet-types { prefix inet; }
  import ietf-dmm-fpcp-base { prefix fpcp-base; }
  import ietf-pmip-qos { prefix qos-pmip; }
  import ietf-traffic-selectors { prefix traffic-selectors; }

  organization "IETF DMM Working Group";

```



```

contact "Satoru Matsushima <satoru.matsushima@g.softbank.co.jp>";

description
"This module contains YANG definition for
Forwarding Policy Configuration Protocol.(FPCP)";

revision 2016-01-19 {
    description "Changes based on -01 version of FPCP draft.";
    reference "draft-ietf-dmm-fpc-cpdp-01";
}

identity fpcp-qos-index-pmip {
    base "fpcp-base:fpcp-qos-index-type";
}

identity traffic-selector-mip6 {
    base "fpcp-base:traffic-descriptor-type";
}

grouping qosattribute-pmip {

    leaf dscp {
        type inet:dscp;
    }

    choice attribute {
        case per-mn-agg-max-dl {
            when "../attributetype = 'Per-MN-Agg-Max-DL-Bit-Rate-type'";
            leaf per-mn-agg-max-dl {
                type qos-pmip:Per-MN-Agg-Max-DL-Bit-Rate-Value;
            }
        }
        case per-mn-agg-max-ul {
            when "../attributetype = 'Per-MN-Agg-Max-UL-Bit-Rate-type'";

```

```

        leaf per-mn-agg-max-ul {
            type qos-pmip:Per-MN-Agg-Max-UL-Bit-Rate-Value;
        }
    }
    case per-session-agg-max {
        when "../attributetype = 'Per-Session-Agg-Max-DL-Bit-Rate-type'
            ../attributetype = 'Per-Session-Agg-Max-UL-Bit-Rate-type'

```

```

        uses qos-pmip:Per-Session-Agg-Max-Bit-Rate-Value;
    }
    case agg-max-dl {
        when "../attributetype = 'Aggregate-Max-DL-Bit-Rate-type'";
        leaf agg-max-dl {
            type qos-pmip:Aggregate-Max-DL-Bit-Rate-Value;
        }
    }
    case agg-max-ul {
        when "../attributetype = 'Aggregate-Max-UL-Bit-Rate-type'";
        leaf agg-max-ul {
            type qos-pmip:Aggregate-Max-UL-Bit-Rate-Value;
        }
    }
    case gbr-dl {
        when "../attributetype = 'Guaranteed-DL-Bit-Rate-type'";
        leaf gbr-dl {
            type qos-pmip:Guaranteed-DL-Bit-Rate-Value;
        }
    }
    case gbr-ul {
        when "../attributetype = 'Guaranteed-UL-Bit-Rate-type'";
        leaf gbr-ul {
            type qos-pmip:Guaranteed-UL-Bit-Rate-Value;
        }
    }
}

// Configuration choice augmentation in the fpcp-base under the fpcp-carrier
augment "/fpcp-base:fpcp-carriers/fpcp-base:carrier/fpcp-base:qos-profile/fpcp-base:qos-profile" {
    case pmip {
        when "/fpcp-base:fpcp-carriers/fpcp-base:carrier/fpcp-base:qos-profile:qos-profile:pmip";
        uses qosattribute-pmip;
    }
}

// Configuration choice augmentation in the fpcp-base under the fpcp-carrier
augment "/fpcp-base:fpcp-carriers/fpcp-base:carrier/fpcp-base:traffic-descriptor" {
    case traffic-selector-mip6 {
        when "/fpcp-base:fpcp-carriers/fpcp-base:carrier/fpcp-base:traffic-descriptor:traffic-selector-mip6";
    }
}

```

```

        uses traffic-selectors:traffic-selector;
    }
}

// Operational choice augmentation in the fpcp-base under the port-entries/
augment "/fpcp-base:port-entries/fpcp-base:port-entry/fpcp-base:property/fpcp-base:property" {
    case pmip {
        when "/fpcp-base:port-entries/fpcp-base:port-entry/fpcp-base:property/fpcp-base:property" {
            uses qosattribute-pmip;
        }
    }
}

// Operational choice augmentation in the fpcp-base under the port-entries/
augment "/fpcp-base:port-entries/fpcp-base:port-entry/fpcp-base:forwarding-fpcp-base:forwarding" {
    case traffic-selector-mip6 {
        when "/fpcp-base:port-entries/fpcp-base:port-entry/fpcp-base:forwarding-fpcp-base:forwarding" {
            uses traffic-selectors:traffic-selector;
        }
    }
}

// RPC choice augmentation in the fpcp-base under "port_add" rpc.
augment "/fpcp-base:port_add/fpcp-base:input/fpcp-base:adding-port/fpcp-base:adding-port" {
    case pmip {
        when "/fpcp-base:port_add/fpcp-base:input/fpcp-base:adding-port/fpcp-base:adding-port" {
            uses qosattribute-pmip;
        }
    }
}

augment "/fpcp-base:port_add/fpcp-base:input/fpcp-base:adding-port/fpcp-base:adding-port" {
    case traffic-selector-mip6 {
        when "/fpcp-base:port_add/fpcp-base:input/fpcp-base:adding-port/fpcp-base:adding-port" {
            uses traffic-selectors:traffic-selector;
        }
    }
}

// RPC choice augmentation in the fpcp-base under "port_property_add" rpc.
augment "/fpcp-base:port_property_add/fpcp-base:input/fpcp-base:adding-property/fpcp-base:adding-property" {
    case pmip {
        when "/fpcp-base:port_property_add/fpcp-base:input/fpcp-base:adding-property/fpcp-base:adding-property" {
            uses qosattribute-pmip;
        }
    }
}

// RPC choice augmentation in the fpcp-base under "port_property_modify" rpc.
augment "/fpcp-base:port_property_modify/fpcp-base:input/fpcp-base:modify-property/fpcp-base:modify-property" {
    case pmip {
        when "/fpcp-base:port_property_modify/fpcp-base:input/fpcp-base:modify-property/fpcp-base:modify-property" {
            uses qosattribute-pmip;
        }
    }
}

```

Internet-Draft

DMM FPC Protocol

March 2016

```

    }
  }

  // RPC choice augmentation in the fpcp-base under "rule_add" rpc.
  augment "/fpcp-base:rule_add/fpcp-base:input/fpcp-base:adding-rule/fpcp-base:
    case traffic-selector-mip6 {
      when "/fpcp-base:rule_add/fpcp-base:input/fpcp-base:adding-rule/fpcp-base:
        uses traffic-selectors:traffic-selector;
    }
  }

  // RPC choice augmentation in the fpcp-base under "rule_modify" rpc.
  augment "/fpcp-base:rule_modify/fpcp-base:input/fpcp-base:modifying-rule/fpcp-base:
    case traffic-selector-mip6 {
      when "/fpcp-base:rule_modify/fpcp-base:input/fpcp-base:modifying-rule/fpcp-base:
        uses traffic-selectors:traffic-selector;
    }
  }
}

```

Figure 21: caption1

6.2.2. FPC PMIP tree

```

module: ietf-dmm-fpcp-pmip
augment /fpcp-base:fpcp-carriers/fpcp-base:carrier/fpcp-base:qos-profile/fpcp-base:
  +--:(pmip)
    +--rw dscp?                inet:dscp
    +--rw (attribute)?
      +--:(per-mn-agg-max-dl)
        | +--rw per-mn-agg-max-dl?    qos-pmip:Per-MN-Agg-Max-DL-Bit-Rate-Value
      +--:(per-mn-agg-max-ul)
        | +--rw per-mn-agg-max-ul?    qos-pmip:Per-MN-Agg-Max-UL-Bit-Rate-Value
      +--:(per-session-agg-max)
        | +--rw max-dl                uint32
        | +--rw service-flag          boolean
        | +--rw exclude-flag          boolean
      +--:(agg-max-dl)
        | +--rw agg-max-dl?           qos-pmip:Aggregate-Max-DL-Bit-Rate-Value
      +--:(agg-max-ul)
        | +--rw agg-max-ul?           qos-pmip:Aggregate-Max-UL-Bit-Rate-Value
      +--:(gbr-dl)

```

```

    | +--rw gbr-dl?                qos-pmip:Guaranteed-DL-Bit-Rate-Value
    +--:(gbr-ul)
      +--rw gbr-ul?                qos-pmip:Guaranteed-UL-Bit-Rate-Value
augment /fpcp-base:fpcp-carriers/fpcp-base:carrier/fpcp-base:traffic-descriptor
+--:(traffic-selector-mip6)

```

```

+--rw ts-format?                  identityref
+--rw start-ipsec-spi?            ipsec-spi
+--rw end-ipsec-spi?              ipsec-spi
+--rw start-source-port?          inet:port-number
+--rw end-source-port?            inet:port-number
+--rw start-destination-port?     inet:port-number
+--rw end-destination-port?       inet:port-number
+--rw start-source-address-v4?    inet:ipv4-address
+--rw end-source-address-v4?      inet:ipv4-address
+--rw start-destination-address-v4? inet:ipv4-address
+--rw end-destination-address-v4? inet:ipv4-address
+--rw start-ds?                    inet:dscp
+--rw end-ds?                      inet:dscp
+--rw start-protocol?              uint8
+--rw end-protocol?                uint8
+--rw start-source-address-v6?     inet:ipv6-address
+--rw end-source-address-v6?       inet:ipv6-address
+--rw start-destination-address-v6? inet:ipv6-address
+--rw end-destination-address-v6?  inet:ipv6-address
+--rw start-flow-label?            inet:ipv6-flow-label
+--rw end-flow-label?              inet:ipv6-flow-label
+--rw start-traffic-class?         inet:dscp
+--rw end-traffic-class?           inet:dscp
+--rw start-next-header?            uint8
+--rw end-next-header?              uint8
augment /fpcp-base:port-entries/fpcp-base:port-entry/fpcp-base:property/fpcp-base:
+--:(pmip)
  +--ro dscp?                       inet:dscp
  +--ro (attribute)?
    +--:(per-mn-agg-max-dl)
      | +--ro per-mn-agg-max-dl?     qos-pmip:Per-MN-Agg-Max-DL-Bit-Rate-Value
    +--:(per-mn-agg-max-ul)
      | +--ro per-mn-agg-max-ul?     qos-pmip:Per-MN-Agg-Max-UL-Bit-Rate-Value
    +--:(per-session-agg-max)
      | +--ro max-dl                  uint32
      | +--ro service-flag            boolean

```

```

    | +--ro exclude-flag          boolean
  +--:(agg-max-dl)
    | +--ro agg-max-dl?         qos-pmip:Aggregate-Max-DL-Bit-Rate-Value
  +--:(agg-max-ul)
    | +--ro agg-max-ul?         qos-pmip:Aggregate-Max-UL-Bit-Rate-Value
  +--:(gbr-dl)
    | +--ro gbr-dl?             qos-pmip:Guaranteed-DL-Bit-Rate-Value
  +--:(gbr-ul)
    | +--ro gbr-ul?             qos-pmip:Guaranteed-UL-Bit-Rate-Value
augment /fpcp-base:port-entries/fpcp-base:port-entry/fpcp-base:forwarding-rule/
  +--:(traffic-selector-mip6)
    +--ro ts-format?            identityref

```

```

+--ro start-ipsec-spi?          ipsec-spi
+--ro end-ipsec-spi?            ipsec-spi
+--ro start-source-port?        inet:port-number
+--ro end-source-port?          inet:port-number
+--ro start-destination-port?   inet:port-number
+--ro end-destination-port?     inet:port-number
+--ro start-source-address-v4?  inet:ipv4-address
+--ro end-source-address-v4?    inet:ipv4-address
+--ro start-destination-address-v4? inet:ipv4-address
+--ro end-destination-address-v4? inet:ipv4-address
+--ro start-ds?                  inet:dscp
+--ro end-ds?                    inet:dscp
+--ro start-protocol?           uint8
+--ro end-protocol?             uint8
+--ro start-source-address-v6?  inet:ipv6-address
+--ro end-source-address-v6?    inet:ipv6-address
+--ro start-destination-address-v6? inet:ipv6-address
+--ro end-destination-address-v6? inet:ipv6-address
+--ro start-flow-label?         inet:ipv6-flow-label
+--ro end-flow-label?           inet:ipv6-flow-label
+--ro start-traffic-class?      inet:dscp
+--ro end-traffic-class?        inet:dscp
+--ro start-next-header?         uint8
+--ro end-next-header?          uint8
augment /fpcp-base:port_add/fpcp-base:input/fpcp-base:adding-port/fpcp-base:port
  +--:(pmip)
    +---- dscp?                  inet:dscp
    +---- (attribute)?
      +--:(per-mn-agg-max-dl)

```

```

    | +---- per-mn-agg-max-dl?   qos-pmip:Per-MN-Agg-Max-DL-Bit-Rate-Value
+--:(per-mn-agg-max-ul)
    | +---- per-mn-agg-max-ul?   qos-pmip:Per-MN-Agg-Max-UL-Bit-Rate-Value
+--:(per-session-agg-max)
    | +---- max-dl               uint32
    | +---- service-flag         boolean
    | +---- exclude-flag         boolean
+--:(agg-max-dl)
    | +---- agg-max-dl?          qos-pmip:Aggregate-Max-DL-Bit-Rate-Value
+--:(agg-max-ul)
    | +---- agg-max-ul?          qos-pmip:Aggregate-Max-UL-Bit-Rate-Value
+--:(gbr-dl)
    | +---- gbr-dl?              qos-pmip:Guaranteed-DL-Bit-Rate-Value
+--:(gbr-ul)
    | +---- gbr-ul?              qos-pmip:Guaranteed-UL-Bit-Rate-Value
augment /fpcp-base:port_add/fpcp-base:input/fpcp-base:adding-port/fpcp-base:for
+--:(traffic-selector-mip6)
    +---- ts-format?             identityref
    +---- start-ipsec-spi?       ipsec-spi

```

```

+---- end-ipsec-spi?           ipsec-spi
+---- start-source-port?       inet:port-number
+---- end-source-port?         inet:port-number
+---- start-destination-port?   inet:port-number
+---- end-destination-port?     inet:port-number
+---- start-source-address-v4?   inet:ipv4-address
+---- end-source-address-v4?     inet:ipv4-address
+---- start-destination-address-v4? inet:ipv4-address
+---- end-destination-address-v4? inet:ipv4-address
+---- start-ds?                 inet:dscp
+---- end-ds?                   inet:dscp
+---- start-protocol?           uint8
+---- end-protocol?             uint8
+---- start-source-address-v6?   inet:ipv6-address
+---- end-source-address-v6?     inet:ipv6-address
+---- start-destination-address-v6? inet:ipv6-address
+---- end-destination-address-v6? inet:ipv6-address
+---- start-flow-label?         inet:ipv6-flow-label
+---- end-flow-label?           inet:ipv6-flow-label
+---- start-traffic-class?       inet:dscp
+---- end-traffic-class?         inet:dscp
+---- start-next-header?         uint8

```

```

+---- end-next-header?          uint8
augment /fpcp-base:port_property_add/fpcp-base:input/fpcp-base:adding-property/
+--:(pmip)
+---- dscp?                    inet:dscp
+---- (attribute)?
+--:(per-mn-agg-max-dl)
| +---- per-mn-agg-max-dl?    qos-pmip:Per-MN-Agg-Max-DL-Bit-Rate-Value
+--:(per-mn-agg-max-ul)
| +---- per-mn-agg-max-ul?    qos-pmip:Per-MN-Agg-Max-UL-Bit-Rate-Value
+--:(per-session-agg-max)
| +---- max-dl                uint32
| +---- service-flag          boolean
| +---- exclude-flag          boolean
+--:(agg-max-dl)
| +---- agg-max-dl?           qos-pmip:Aggregate-Max-DL-Bit-Rate-Value
+--:(agg-max-ul)
| +---- agg-max-ul?           qos-pmip:Aggregate-Max-UL-Bit-Rate-Value
+--:(gbr-dl)
| +---- gbr-dl?               qos-pmip:Guaranteed-DL-Bit-Rate-Value
+--:(gbr-ul)
| +---- gbr-ul?               qos-pmip:Guaranteed-UL-Bit-Rate-Value
augment /fpcp-base:port_property_modify/fpcp-base:input/fpcp-base:modifying-property/
+--:(pmip)
+---- dscp?                    inet:dscp
+---- (attribute)?
+--:(per-mn-agg-max-dl)

```

```

| +---- per-mn-agg-max-dl?    qos-pmip:Per-MN-Agg-Max-DL-Bit-Rate-Value
+--:(per-mn-agg-max-ul)
| +---- per-mn-agg-max-ul?    qos-pmip:Per-MN-Agg-Max-UL-Bit-Rate-Value
+--:(per-session-agg-max)
| +---- max-dl                uint32
| +---- service-flag          boolean
| +---- exclude-flag          boolean
+--:(agg-max-dl)
| +---- agg-max-dl?           qos-pmip:Aggregate-Max-DL-Bit-Rate-Value
+--:(agg-max-ul)
| +---- agg-max-ul?           qos-pmip:Aggregate-Max-UL-Bit-Rate-Value
+--:(gbr-dl)
| +---- gbr-dl?               qos-pmip:Guaranteed-DL-Bit-Rate-Value
+--:(gbr-ul)
| +---- gbr-ul?               qos-pmip:Guaranteed-UL-Bit-Rate-Value

```



```

augment /fpcp-base:rule_add/fpcp-base:input/fpcp-base:adding-rule/fpcp-base:for
  +--:(traffic-selector-mip6)
    +---- ts-format?                identityref
    +---- start-ipsec-spi?          ipsec-spi
    +---- end-ipsec-spi?            ipsec-spi
    +---- start-source-port?        inet:port-number
    +---- end-source-port?          inet:port-number
    +---- start-destination-port?   inet:port-number
    +---- end-destination-port?     inet:port-number
    +---- start-source-address-v4?  inet:ipv4-address
    +---- end-source-address-v4?    inet:ipv4-address
    +---- start-destination-address-v4? inet:ipv4-address
    +---- end-destination-address-v4? inet:ipv4-address
    +---- start-ds?                 inet:dscp
    +---- end-ds?                   inet:dscp
    +---- start-protocol?           uint8
    +---- end-protocol?             uint8
    +---- start-source-address-v6?  inet:ipv6-address
    +---- end-source-address-v6?    inet:ipv6-address
    +---- start-destination-address-v6? inet:ipv6-address
    +---- end-destination-address-v6? inet:ipv6-address
    +---- start-flow-label?         inet:ipv6-flow-label
    +---- end-flow-label?           inet:ipv6-flow-label
    +---- start-traffic-class?      inet:dscp
    +---- end-traffic-class?        inet:dscp
    +---- start-next-header?        uint8
    +---- end-next-header?          uint8

```

```

augment /fpcp-base:rule_modify/fpcp-base:input/fpcp-base:modifying-rule/fpcp-ba
  +--:(traffic-selector-mip6)
    +---- ts-format?                identityref
    +---- start-ipsec-spi?          ipsec-spi
    +---- end-ipsec-spi?            ipsec-spi
    +---- start-source-port?        inet:port-number

```

```

+---- end-source-port?            inet:port-number
+---- start-destination-port?     inet:port-number
+---- end-destination-port?       inet:port-number
+---- start-source-address-v4?    inet:ipv4-address
+---- end-source-address-v4?      inet:ipv4-address
+---- start-destination-address-v4? inet:ipv4-address
+---- end-destination-address-v4? inet:ipv4-address
+---- start-ds?                   inet:dscp

```

```

+---- end-ds?                inet:dscp
+---- start-protocol?        uint8
+---- end-protocol?         uint8
+---- start-source-address-v6? inet:ipv6-address
+---- end-source-address-v6? inet:ipv6-address
+---- start-destination-address-v6? inet:ipv6-address
+---- end-destination-address-v6? inet:ipv6-address
+---- start-flow-label?     inet:ipv6-flow-label
+---- end-flow-label?      inet:ipv6-flow-label
+---- start-traffic-class?  inet:dscp
+---- end-traffic-class?   inet:dscp
+---- start-next-header?    uint8
+---- end-next-header?     uint8

```

Figure 22: FPC PMIP tree

7. Security Considerations

Detailed protocol implementations for DMM Forwarding Policy Configuration must ensure integrity of the information exchanged between an FPC Client and an FPC Agent. Required Security Associations may be derived from co-located functions, which utilize the FPC Client and FPC Agent respectively.

8. IANA Considerations

This document provides a data model and protocol operation for DMM Forwarding Policy Configuration. Yang models are included to specify the data model as well as to enable an implementation of this protocol using RPC.

No actions from IANA are required. In case the semantics of this specification will be mapped to a particular wire protocol, authors of an associated separate document will approach IANA for the associated action to create a registry or add registry entries.

9. Work Team Participants

Participants in the FPSM work team discussion include Satoru Matsushima, Danny Moses, Sri Gundavelli, Marco Liebsch, Pierrick Seite, Alper Yegin, Carlos Bernardos, Charles Perkins and Fred Templin.

10. References

10.1. Normative References

- [RFC2119] Bradner, S., "Key words for use in RFCs to Indicate Requirement Levels", [BCP 14](#), [RFC 2119](#), DOI 10.17487/RFC2119, March 1997, <<http://www.rfc-editor.org/info/rfc2119>>.
- [RFC6088] Tsirtsis, G., Giarreta, G., Soliman, H., and N. Montavont, "Traffic Selectors for Flow Bindings", [RFC 6088](#), DOI 10.17487/RFC6088, January 2011, <<http://www.rfc-editor.org/info/rfc6088>>.
- [RFC7333] Chan, H., Ed., Liu, D., Seite, P., Yokota, H., and J. Korhonen, "Requirements for Distributed Mobility Management", [RFC 7333](#), DOI 10.17487/RFC7333, August 2014, <<http://www.rfc-editor.org/info/rfc7333>>.
- [RFC7429] Liu, D., Ed., Zuniga, JC., Ed., Seite, P., Chan, H., and CJ. Bernardos, "Distributed Mobility Management: Current Practices and Gap Analysis", [RFC 7429](#), DOI 10.17487/RFC7429, January 2015, <<http://www.rfc-editor.org/info/rfc7429>>.

10.2. Informative References

- [RFC3344] Perkins, C., Ed., "IP Mobility Support for IPv4", [RFC 3344](#), DOI 10.17487/RFC3344, August 2002, <<http://www.rfc-editor.org/info/rfc3344>>.
- [RFC5213] Gundavelli, S., Ed., Leung, K., Devarapalli, V., Chowdhury, K., and B. Patil, "Proxy Mobile IPv6", [RFC 5213](#), DOI 10.17487/RFC5213, August 2008, <<http://www.rfc-editor.org/info/rfc5213>>.
- [RFC7222] Liebsch, M., Seite, P., Yokota, H., Korhonen, J., and S. Gundavelli, "Quality-of-Service Option for Proxy Mobile IPv6", [RFC 7222](#), DOI 10.17487/RFC7222, May 2014, <<http://www.rfc-editor.org/info/rfc7222>>.

Authors' Addresses

Marco Liebsch
NEC Laboratories Europe
NEC Europe Ltd.
Kurfuersten-Anlage 36
D-69115 Heidelberg
Germany

Phone: +49 6221 4342146
Email: liebsch@neclab.eu

Satoru Matsushima
SoftBank
1-9-1, Higashi-Shimbashi, Minato-Ku
Tokyo 105-7322
Japan

Email: satoru.matsushima@g.softbank.co.jp

Sri Gundavelli
Cisco
170 West Tasman Drive
San Jose, CA 95134
USA

Email: sgundave@cisco.com

Danny Moses

Email: danny.moses@intel.com

Lyle Bertz
6220 Sprint Parkway
Overland Park KS, 66251
USA

Email: lyleb551144@gmail.com

