

Network Working Group  
Internet-Draft  
Obsoletes: [8889](#) (if approved)  
Intended status: Standards Track  
Expires: October 28, 2022

G. Fioccola, Ed.  
Huawei Technologies  
M. Cociglio  
Telecom Italia  
A. Sapiro  
Intel Corporation  
R. Sisto  
Politecnico di Torino  
T. Zhou  
Huawei Technologies  
April 26, 2022

Multipoint Alternate-Marking Method  
draft-ietf-ippm-rfc8889bis-00

## Abstract

This document generalizes and expands Alternate-Marking methodology to measure any kind of unicast flow whose packets can follow several different paths in the network -- in wider terms, a multipoint-to-multipoint network. For this reason, the technique here described is called "Multipoint Alternate Marking". This document obsoletes [[RFC8889](#)].

## Status of This Memo

This Internet-Draft is submitted in full conformance with the provisions of [BCP 78](#) and [BCP 79](#).

Internet-Drafts are working documents of the Internet Engineering Task Force (IETF). Note that other groups may also distribute working documents as Internet-Drafts. The list of current Internet-Drafts is at <https://datatracker.ietf.org/drafts/current/>.

Internet-Drafts are draft documents valid for a maximum of six months and may be updated, replaced, or obsoleted by other documents at any time. It is inappropriate to use Internet-Drafts as reference material or to cite them other than as "work in progress."

This Internet-Draft will expire on October 28, 2022.

## Copyright Notice

Copyright (c) 2022 IETF Trust and the persons identified as the document authors. All rights reserved.

Internet-Draft

ClustAltMark

April 2022

This document is subject to [BCP 78](https://trustee.ietf.org/license-info) and the IETF Trust's Legal Provisions Relating to IETF Documents (<https://trustee.ietf.org/license-info>) in effect on the date of publication of this document. Please review these documents carefully, as they describe your rights and restrictions with respect to this document. Code Components extracted from this document must include Simplified BSD License text as described in Section 4.e of the Trust Legal Provisions and are provided without warranty as described in the Simplified BSD License.

## Table of Contents

<a href="#">1.</a>	Introduction . . . . .	<a href="#">2</a>
<a href="#">1.1.</a>	Requirements Language . . . . .	<a href="#">5</a>
<a href="#">2.</a>	Terminology . . . . .	<a href="#">5</a>
<a href="#">2.1.</a>	Correlation with <a href="#">RFC 5644</a> . . . . .	<a href="#">6</a>
<a href="#">3.</a>	Flow Classification . . . . .	<a href="#">6</a>
<a href="#">4.</a>	Extension of the Method to Multipoint Flows . . . . .	<a href="#">9</a>
<a href="#">4.1.</a>	Monitoring Network . . . . .	<a href="#">9</a>
<a href="#">4.2.</a>	Network Packet Loss . . . . .	<a href="#">10</a>
<a href="#">5.</a>	Network Clustering . . . . .	<a href="#">11</a>
<a href="#">5.1.</a>	Algorithm for Clusters Partition . . . . .	<a href="#">12</a>
<a href="#">6.</a>	Multipoint Packet Loss Measurement . . . . .	<a href="#">16</a>
<a href="#">7.</a>	Multipoint Delay and Delay Variation . . . . .	<a href="#">16</a>
<a href="#">7.1.</a>	Delay Measurements on a Multipoint-Paths Basis . . . . .	<a href="#">17</a>
<a href="#">7.1.1.</a>	Single-Marking Measurement . . . . .	<a href="#">17</a>
<a href="#">7.2.</a>	Delay Measurements on a Single-Packet Basis . . . . .	<a href="#">17</a>
<a href="#">7.2.1.</a>	Single- and Double-Marking Measurement . . . . .	<a href="#">17</a>
<a href="#">7.2.2.</a>	Hashing Selection Method . . . . .	<a href="#">18</a>
<a href="#">8.</a>	Synchronization and Timing . . . . .	<a href="#">19</a>
<a href="#">9.</a>	Results of the Multipoint Alternate Marking Experiment . . . . .	<a href="#">21</a>
<a href="#">10.</a>	A Closed-Loop Performance-Management Approach . . . . .	<a href="#">21</a>
<a href="#">11.</a>	Security Considerations . . . . .	<a href="#">23</a>
<a href="#">12.</a>	IANA Considerations . . . . .	<a href="#">23</a>
<a href="#">13.</a>	Contributors . . . . .	<a href="#">23</a>
<a href="#">14.</a>	Acknowledgements . . . . .	<a href="#">23</a>
<a href="#">15.</a>	References . . . . .	<a href="#">24</a>
<a href="#">15.1.</a>	Normative References . . . . .	<a href="#">24</a>
<a href="#">15.2.</a>	Informative References . . . . .	<a href="#">24</a>
<a href="#">Appendix A.</a>	Changes Log . . . . .	<a href="#">25</a>
	Authors' Addresses . . . . .	<a href="#">26</a>

[1.](#) Introduction

The Alternate-Marking method, as described in [\[I-D.fioccola-rfc8321bis\]](#), is applicable to a point-to-point path. The extension proposed in this document applies to the most general

case of a multipoint-to-multipoint path and enables flexible and adaptive performance measurements in a managed network.

The Alternate-Marking methodology described in [\[I-D.fioccola-rfc8321bis\]](#) allows the synchronization of the measurements at different points by dividing the packet flow into batches. So it is possible to get coherent counters and show what is happening in every marking period for each monitored flow. The monitoring parameters are the packet counter and timestamps of a flow for each marking period. Note that additional details about the applicability of the Alternate-Marking methodology are described in [\[I-D.fioccola-rfc8321bis\]](#) while implementation details can be found in the paper "AM-PM: Efficient Network Telemetry using Alternate Marking" [\[IEEE-Network-PNPM\]](#).

There are some applications of the Alternate-Marking method where there are a lot of monitored flows and nodes. Multipoint Alternate Marking aims to reduce these values and makes the performance monitoring more flexible in case a detailed analysis is not needed. For instance, by considering  $n$  measurement points and  $m$  monitored flows, the order of magnitude of the packet counters for each time interval is  $n*m*2$  (1 per color). The number of measurement points and monitored flows may vary and depends on the portion of the network we are monitoring (core network, metro network, access network) and the granularity (for each service, each customer). So if both  $n$  and  $m$  are high values, the packet counters increase a lot, and Multipoint Alternate Marking offers a tool to control these parameters.

The approach presented in this document is applied only to unicast flows and not to multicast. Broadcast, Unknown Unicast, and Multicast (BUM) traffic is not considered here, because traffic replication is not covered by the Multipoint Alternate-Marking method. Furthermore, it can be applicable to anycast flows, and Equal-Cost Multipath (ECMP) paths can also be easily monitored with this technique.

[I-D.fioccola-rfc8321bis] applies to point-to-point unicast flows and BUM traffic. For BUM traffic, the basic method of [I-D.fioccola-rfc8321bis] can easily be applied link by link and therefore split the multicast flow tree distribution into separate unicast point-to-point links. While this document and its Clustered Alternate-Marking method is valid for multipoint-to-multipoint unicast flows, anycast, and ECMP flows.

Therefore, the Alternate-Marking method can be extended to any kind of multipoint-to-multipoint paths, and the network-clustering approach presented in this document is the formalization of how to

implement this property and allow a flexible and optimized performance measurement support for network management in every situation.

Without network clustering, it is possible to apply Alternate Marking only for all the network or per single flow. Instead, with network clustering, it is possible to use the partition of the network into clusters at different levels in order to provide the needed degree of detail. In some circumstances, it is possible to monitor a multipoint network by monitoring the network clusters, without examining in depth. In case of problems (packet loss is measured or the delay is too high), the filtering criteria could be enhanced in order to perform a detailed analysis by using a different combination of clusters up to a per-flow measurement as described in [I-D.fioccola-rfc8321bis].

This approach fits very well with the Closed-Loop Network and Software-Defined Network (SDN) paradigm, where the SDN orchestrator and the SDN controllers are the brains of the network and can manage flow control to the switches and routers and, in the same way, can calibrate the performance measurements depending on the desired accuracy. An SDN controller application can orchestrate how accurately the network performance monitoring is set up by applying the Multipoint Alternate Marking as described in this document.

It is important to underline that, as an extension of [I-D.fioccola-rfc8321bis], this is a methodology document, so the mechanism that can be used to transmit the counters and the timestamps is out of scope here, and the implementation is open.

Several options are possible -- e.g., see "Enhanced Alternate Marking Method" [[I-D.zhou-ippm-enhanced-alternate-marking](#)].

This document assumes that the blocks are created according to a fixed timer as per [[I-D.fioccola-rfc8321bis](#)]. Switching after a fixed number of packets is possible but it is out of scope here.

Note that the fragmented packets case can be managed with the Alternate-Marking methodology. The same considerations of [[I-D.fioccola-rfc8321bis](#)] apply also in the case of Multipoint Alternate Marking. As defined in [[I-D.fioccola-rfc8321bis](#)] the marking node MUST mark all the fragments except in the case of fragmentation within the network domain, in that event it is suggested to mark only the first fragment.

## [1.1](#). Requirements Language

The key words "MUST", "MUST NOT", "REQUIRED", "SHALL", "SHALL NOT", "SHOULD", "SHOULD NOT", "RECOMMENDED", "NOT RECOMMENDED", "MAY", and "OPTIONAL" in this document are to be interpreted as described in [BCP 14](#) [[RFC2119](#)] [[RFC8174](#)] when, and only when, they appear in all capitals, as shown here.

## [2](#). Terminology

The definitions of the basic terms are identical to those found in Alternate Marking [[I-D.fioccola-rfc8321bis](#)]. It is to be remembered that [[I-D.fioccola-rfc8321bis](#)] is valid for point-to-point unicast flows and BUM traffic.

The important new terms that need to be explained are listed below:

Multipoint Alternate Marking: Extension to [[I-D.fioccola-rfc8321bis](#)], valid for multipoint-to-multipoint unicast flows, anycast, and ECMP flows. It can also be referred to as Clustered Alternate Marking.

Flow definition: The concept of flow is generalized in this document. The identification fields are selected without any constraints and, in general, the flow can be a multipoint-to-multipoint flow, as a result of aggregate point-to-point flows.

Monitoring Network: Identified with the nodes of the network that are the measurement points (MPs) and the links that are the connections between MPs. The monitoring network graph depends on the flow definition, so it can represent a specific flow or the entire network topology as aggregate of all the flows.

Cluster: Smallest identifiable subnetwork of the entire monitoring network graph that still satisfies the condition that the number of packets that go in is the same as the number that go out.

Multipoint metrics: Packet loss, delay and delay variation are extended to the case of multipoint flows. It is possible to compute these metrics on the basis of multipoint paths in order to associate the measurements to a cluster, a combination of clusters, or the entire monitored network. For delay and delay variation, it is also possible to define the metrics on a single-packet basis, and it means that the multipoint path is used to easily couple packets between input and output nodes of a multipoint path.

The next section highlights the correlation with the terms used in [RFC 5644](#) [[RFC5644](#)].

### 2.1. Correlation with [RFC 5644](#)

[RFC 5644](#) [[RFC5644](#)] is limited to active measurements using a single source packet or stream. Its scope is also limited to observations of corresponding packets along the path (spatial metric) and at one or more destinations (one-to-group) along the path.

Instead, the scope of this memo is to define multiparty metrics for passive and hybrid measurements in a group-to-group topology with multiple sources and destinations.

[RFC 5644](#) [[RFC5644](#)] introduces metric names that can be reused here

but have to be extended and rephrased to be applied to the Alternate-Marking schema:

- a. the multiparty metrics are not only one-to-group metrics but can be also group-to-group metrics;
- b. the spatial metrics, used for measuring the performance of segments of a source to destination path, are applied here to group-to-group segments (called clusters).

### 3. Flow Classification

A unicast flow is identified by all the packets having a set of common characteristics. This definition is inspired by [RFC 7011](#) [[RFC7011](#)].

As an example, by considering a flow as all the packets sharing the same source IP address or the same destination IP address, it is easy to understand that the resulting pattern will not be a point-to-point connection, but a point-to-multipoint or multipoint-to-point connection.

In general, a flow can be defined by a set of selection rules used to match a subset of the packets processed by the network device. These rules specify a set of Layer 3 and Layer 4 header fields (identification fields) and the relative values that must be found in matching packets.

The choice of the identification fields directly affects the type of paths that the flow would follow in the network. In fact, it is possible to relate a set of identification fields with the pattern of the resulting graphs, as listed in Figure 1.

A TCP 5-tuple usually identifies flows following either a single path or a point-to-point multipath (in the case of load balancing). On the contrary, a single source address selects aggregate flows following a point-to-multipoint, while a multipoint-to-point can be the result of a matching on a single destination address. In the case where a selection rule and its reverse are used for bidirectional measurements, they can correspond to a point-to-multipoint in one direction and a multipoint-to-point in the opposite

direction.

So the flows to be monitored are selected into the monitoring points using packet selection rules, which can also change the pattern of the monitored network.

Note that, more generally, the flow can be defined at different levels based on the potential encapsulation, and additional conditions that are not in the packet header can also be included as part of matching criteria.

The Alternate-Marking method is applicable only to a single path (and partially to a one-to-one multipath), so the extension proposed in this document is suitable also for the most general case of multipoint-to-multipoint, which embraces all the other patterns of Figure 1.

point-to-point single path

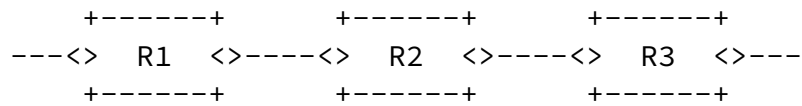

point-to-point multipath

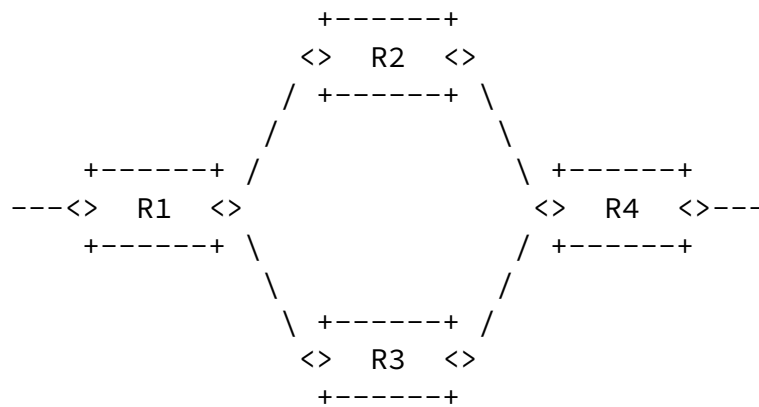

point-to-multipoint

```
+-----+
```



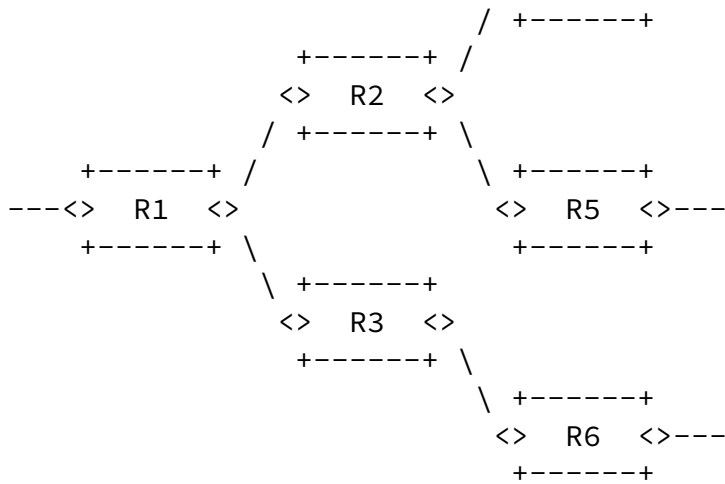

multipoint-to-point

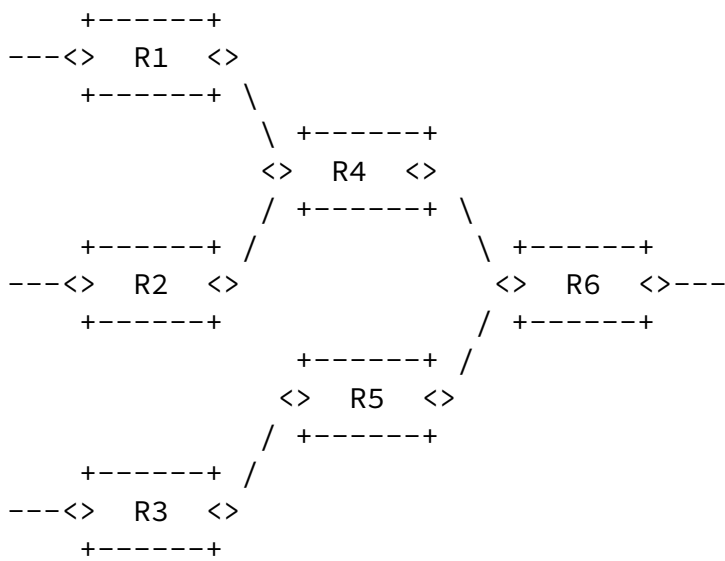

multipoint-to-multipoint

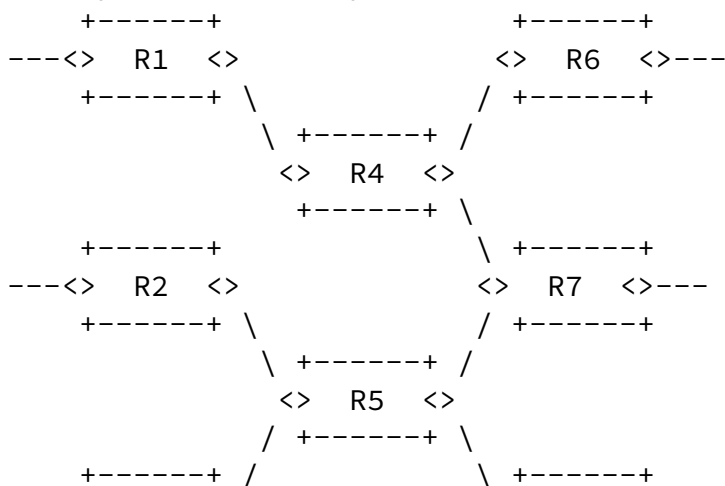



Figure 1: Flow Classification

The case of unicast flow is considered in Figure 1. The anycast flow is also in scope, because there is no replication and only a single node from the anycast group receives the traffic, so it can be viewed as a special case of unicast flow. Furthermore, an ECMP flow is in scope by definition, since it is a point-to-multipoint unicast flow.

#### [4.](#) Extension of the Method to Multipoint Flows

By using the Alternate-Marking method, only point-to-point paths can be monitored. To have an IP (TCP/UDP) flow that follows a point-to-point path, in general we have to define, with a specific value, 5 identification fields (IP Source, IP Destination, Transport Protocol, Source Port, Destination Port).

Multipoint Alternate Marking enables the performance measurement for multipoint flows selected by identification fields without any constraints (even the entire network production traffic). It is also possible to use multiple marking points for the same monitored flow.

##### [4.1.](#) Monitoring Network

The monitoring network is deduced from the production network by identifying the nodes of the graph that are the measurement points, and the links that are the connections between measurement points.

There are some techniques that can help with the building of the monitoring network (as an example, see [[I-D.ietf-ippm-route](#)]). In general, there are different options: the monitoring network can be obtained by considering all the possible paths for the traffic or periodically checking the traffic (e.g. daily, weekly, monthly) and updating the graph as appropriate, but this is up to the Network Management System (NMS) configuration.

So a graph model of the monitoring network can be built according to the Alternate-Marking method: the monitored interfaces and links are identified. Only the measurement points and links where the traffic has flowed have to be represented in the graph.

Figure 2 shows a simple example of a monitoring network graph:

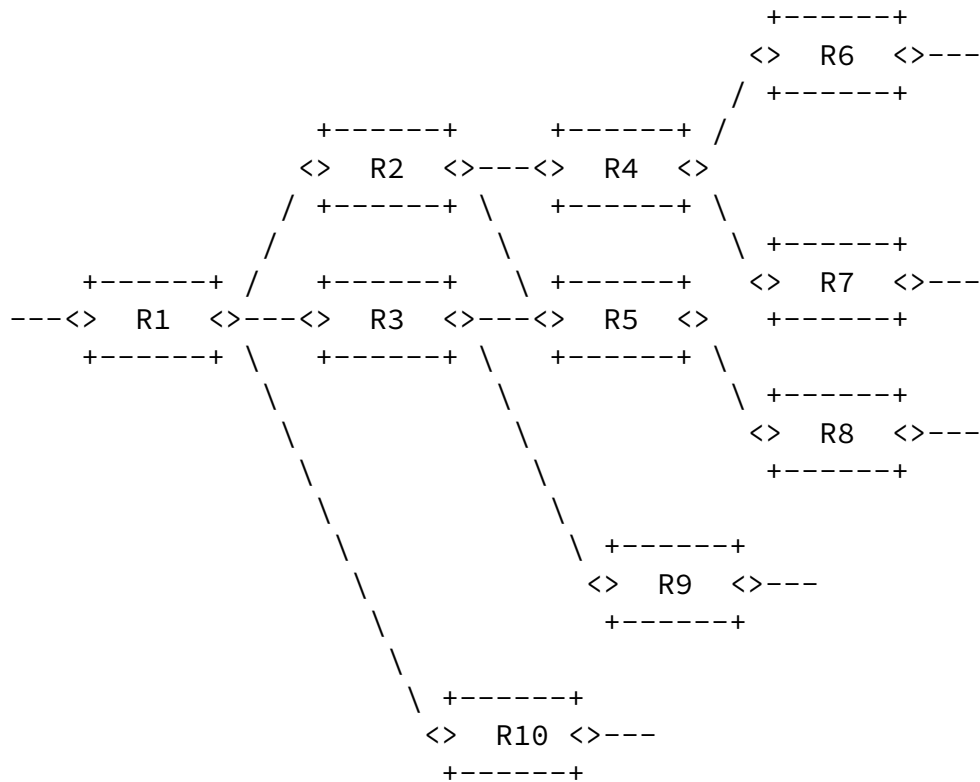

Figure 2: Monitoring Network Graph

Each monitoring point is characterized by the packet counter that refers only to a marking period of the monitored flow. Also, it is assumed that there be a monitoring point at all possible egress points of the multipoint monitored network.

The same is also applicable for the delay, but it will be described in the following sections.

The rest of the document assumes that the traffic is going from left to right in order to simplify the explanation. But the analysis done for one direction applies equally to all directions.

[4.2.](#) Network Packet Loss

Since all the packets of the considered flow leaving the network have previously entered the network, the number of packets counted by all the input nodes is always greater than, or equal to, the number of packets counted by all the output nodes. Non-initial fragments are not considered here.

In the case of no packet loss occurring in the marking period, if all the input and output points of the network domain to be monitored are measurement points, the sum of the number of packets on all the

ingress interfaces equals the number on egress interfaces for the monitored flow. In this circumstance, if no packet loss occurs, the intermediate measurement points only have the task of splitting the measurement.

It is possible to define the Network Packet Loss of one monitored flow for a single period. In a packet network, the number of lost packets is the number of packets counted by the input nodes minus the number of packets counted by the output nodes. This is true for every packet flow in each marking period.

The monitored network packet loss with  $n$  input nodes and  $m$  output nodes is given by:

$$PL = (PI_1 + PI_2 + \dots + PI_n) - (PO_1 + PO_2 + \dots + PO_m)$$

where:

PL is the network packet loss (number of lost packets)

$PI_i$  is the number of packets flowed through the  $i$ -th input node in this period

$PO_j$  is the number of packets flowed through the  $j$ -th output node in this period

The equation is applied on a per-time-interval basis and a per-flow basis:

The reference interval is the Alternate-Marking period, as defined in [[I-D.fioccola-rfc8321bis](#)].

The flow definition is generalized here. Indeed, as described before, a multipoint packet flow is considered, and the identification fields can be selected without any constraints.

## 5. Network Clustering

The previous equation of [Section 4.2](#) can determine the number of packets lost globally in the monitored network, exploiting only the data provided by the counters in the input and output nodes.

In addition, it is also possible to leverage the data provided by the other counters in the network to converge on the smallest identifiable subnetworks where the losses occur. These subnetworks are named "clusters".

A cluster graph is a subnetwork of the entire monitoring network graph that still satisfies the packet loss equation (introduced in the previous section), where PL in this case is the number of packets lost in the cluster. As for the entire monitoring network graph, the cluster is defined on a per-flow basis.

For this reason, a cluster should contain all the arcs emanating from its input nodes and all the arcs terminating at its output nodes. This ensures that we can count all the packets (and only those) exiting an input node again at the output node, whatever path they follow.

In a completely monitored unidirectional network (a network where every network interface is monitored), each network device corresponds to a cluster, and each physical link corresponds to two clusters (one for each device).

Clusters can have different sizes depending on the flow-filtering criteria adopted.

Moreover, sometimes clusters can be optionally simplified. For example, when two monitored interfaces are divided by a single router (one is the input interface, the other is the output interface, and the router has only these two interfaces), instead of counting exactly twice, upon entering and leaving, it is possible to consider

a single measurement point. In this case, we do not care about the internal packet loss of the router.

It is worth highlighting that it might also be convenient to define clusters based on the topological information so that they are applicable to all the possible flows in the monitored network.

### 5.1. Algorithm for Clusters Partition

A simple algorithm can be applied in order to split our monitoring network into clusters. This can be done for each direction separately. The clusters partition is based on the monitoring network graph, which can be valid for a specific flow or can also be general and valid for the entire network topology.

It is a two-step algorithm:

- o Group the links where there is the same starting node;
- o Join the grouped links with at least one ending node in common.

Considering that the links are unidirectional, the first step implies listing all the links as connections between two nodes and grouping

the different links if they have the same starting node. Note that it is possible to start from any link, and the procedure will work. Following this classification, the second step implies eventually joining the groups classified in the first step by looking at the ending nodes. If different groups have at least one common ending node, they are put together and belong to the same set. After the application of the two steps of the algorithm, each one of the composed sets of links, together with the endpoint nodes, constitutes a cluster.

In our monitoring network graph example, it is possible to identify the clusters partition by applying this two-step algorithm.

The first step identifies the following groups:

1. Group 1: (R1-R2), (R1-R3), (R1-R10)
2. Group 2: (R2-R4), (R2-R5)

3. Group 3: (R3-R5), (R3-R9)
4. Group 4: (R4-R6), (R4-R7)
5. Group 5: (R5-R8)

And then, the second step builds the clusters partition (in particular, we can underline that Groups 2 and 3 connect together, since R5 is in common):

1. Cluster 1: (R1-R2), (R1-R3), (R1-R10)
2. Cluster 2: (R2-R4), (R2-R5), (R3-R5), (R3-R9)
3. Cluster 3: (R4-R6), (R4-R7)
4. Cluster 4: (R5-R8)

The flow direction here considered is from left to right. For the opposite direction, the same reasoning can be applied, and in this example, you get the same clusters partition.

In the end, the following 4 clusters are obtained:

Cluster 1

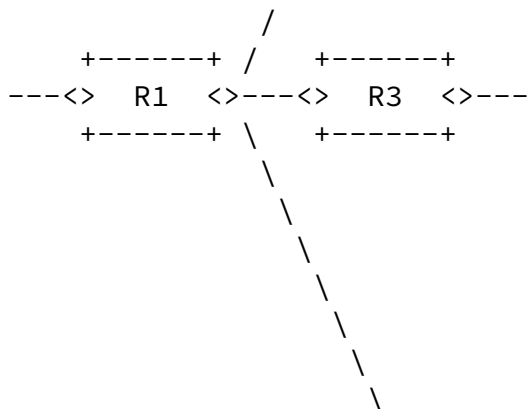
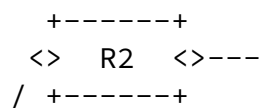

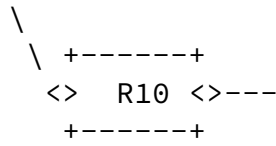

Cluster 2

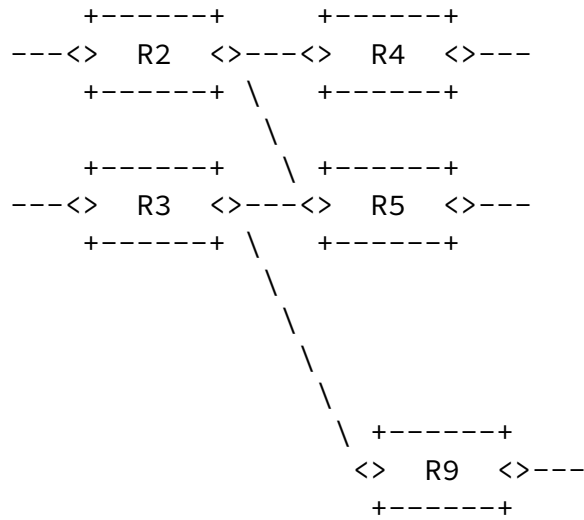

Cluster 3

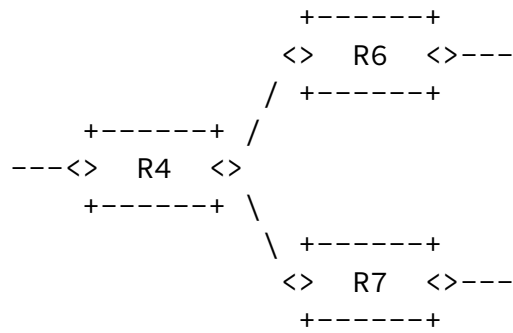

Cluster 4

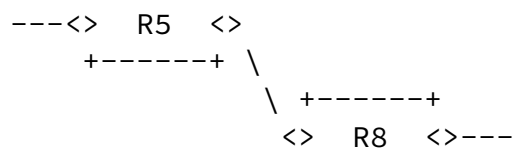
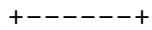



+-----+

Figure 3: Clusters Example

There are clusters with more than two nodes as well as two-node clusters. In the two-node clusters, the loss is on the link (Cluster 4). In more-than-two-node clusters, the loss is on the cluster, but we cannot know in which link (Cluster 1, 2, or 3).

The algorithm, as applied in this example of a point-to-multipoint network, works for the more general case of multipoint-to-multipoint network in the same way. It should be highlighted that for a multipoint-to-multipoint network the multiple sources MUST mark coherently the traffic and MUST be synchronized with all the other nodes according to the timing requirements detailed in [Section 8](#).

When the clusters partition is done, the calculation of packet loss, delay and delay variation can be made on a cluster basis. Note that the packet counters for each marking period permit calculating the packet rate on a cluster basis, so Committed Information Rate (CIR) and Excess Information Rate (EIR) could also be deduced on a cluster basis.

Obviously, by combining some clusters in a new connected subnetwork the packet-loss rule is still true. So it is also possible to consider combinations of clusters if and where it suits.

In this way, in a very large network, there is no need to configure detailed filter criteria to inspect the traffic. It is possible to check a multipoint network and, in case of problems, go deep with a step-by-step cluster analysis, but only for the cluster or combination of clusters where the problem happens.

In summary, once a flow is defined, the algorithm to build the clusters partition is based on topological information; therefore, it considers all the possible links and nodes crossed by the given flow, even if there is no traffic. So, if the flow does not enter or traverse all the nodes, the counters have a non-zero value for the involved nodes and a zero value for the other nodes without traffic; but in the end, all the formulas are still valid.

The algorithm described above network is an iterative clustering algorithm, but it is also possible to apply a recursive clustering

algorithm by using the node-node adjacency matrix representation [[IEEE-ACM-ToN-MPNPM](#)].

The complete and mathematical analysis of the possible algorithms for clusters partition, including the considerations in terms of efficiency and a comparison between the different methods, is in the paper [[IEEE-ACM-ToN-MPNPM](#)].

## 6. Multipoint Packet Loss Measurement

The Network Packet Loss, defined in [Section 4.2](#), valid for the an entire monitored flow, can easily be extended to each multipoint path (e.g., the whole multipoint network, a cluster, or a combination of clusters). In this way it is possible to calculate Multipoint Packet Loss that is representative of a multipoint path.

The same equation of [Section 4.2](#) can be applied to a generic multipoint path like a cluster or a combination of clusters, where the number of packets are those entering and leaving the multipoint path.

By applying the algorithm described in [Section 5.1](#), it is possible to split the monitoring network into clusters. Then, packet loss can be measured on a cluster basis for each single period by considering the counters of the input and output nodes that belong to the specific cluster. This can be done for every packet flow in each marking period.

## 7. Multipoint Delay and Delay Variation

The same line of reasoning can be applied to delay and delay variation. Similarly to the delay measurements defined in [[I-D.fioccola-rfc8321bis](#)], the marking batches anchor the samples to a particular period, and this is the time reference that can be used. It is important to highlight that both delay and delay-variation measurements make sense in a multipoint path. The delay variation is calculated by considering the same packets selected for measuring the delay.

In general, it is possible to perform delay and delay-variation measurements on the basis of multipoint paths or single packets:

- o Delay measurements on the basis of multipoint paths mean that the delay value is representative of an entire multipoint path (e.g., the whole multipoint network, a cluster, or a combination of clusters).

Internet-Draft

ClustAltMark

April 2022

- o Delay measurements on a single-packet basis mean that you can use a multipoint path just to easily couple packets between input and output nodes of a multipoint path, as described in the following sections.

## [7.1.](#) Delay Measurements on a Multipoint-Paths Basis

### [7.1.1.](#) Single-Marking Measurement

Mean delay and mean delay-variation measurements can also be generalized to the case of multipoint flows. It is possible to compute the average one-way delay of packets in one block, a cluster, or the entire monitored network.

The average latency can be measured as the difference between the weighted averages of the mean timestamps of the sets of output and input nodes. This means that, in the calculation, it is possible to weigh the timestamps by considering the number of packets for each endpoints.

Note that, since the one-way delay value is representative of a multipoint path, it is possible to calculate the two-way delay of a multipoint path by summing the one-way delays of the two directions, similarly to [[I-D.fioccola-rfc8321bis](#)].

## [7.2.](#) Delay Measurements on a Single-Packet Basis

### [7.2.1.](#) Single- and Double-Marking Measurement

Delay and delay-variation measurements relative to only one picked packet per period (both single and double marked) can be performed in the multipoint scenario, with some limitations:

Single marking based on the first/last packet of the interval would not work, because it would not be possible to agree on the first packet of the interval.

Double marking or multiplexed marking would work, but each measurement would only give information about the delay of a single path. However, by repeating the measurement multiple

times, it is possible to get information about all the paths in the multipoint flow. This can be done in the case of a point-to-multipoint path, but it is more difficult to achieve in the case of a multipoint-to-multipoint path because of the multiple source routers.

If we would perform a delay measurement for more than one picked packet in the same marking period, and especially if we want to get

delay measurements on a multipoint-to-multipoint basis, neither the single- nor the double-marking method is useful in the multipoint scenario, since they would not be representative of the entire flow. The packets can follow different paths with various delays, and in general it can be very difficult to recognize marked packets in a multipoint-to-multipoint path, especially in the case when there is more than one per period.

A desirable option is to monitor simultaneously all the paths of a multipoint path in the same marking period; for this purpose, hashing can be used, as reported in the next section.

Note that, since the one-way delay measurement is done on a single-packet basis, it is always possible to calculate the two-way delay but it is not immediate since it is necessary to couple the measurement on each single path with the opposite direction. In this case the NMS can do the calculation.

### 7.2.2. Hashing Selection Method

RFCs 5474 [[RFC5474](#)] and 5475 [[RFC5475](#)] introduce sampling and filtering techniques for IP packet selection.

The hash-based selection methodologies for delay measurement can work in a multipoint-to-multipoint path and MAY be used either coupled to mean delay or stand-alone.

[I-D.mizrahi-ippm-marking] introduces how to use the hash method ([RFC 5474](#) [[RFC5474](#)] and [RFC 5475](#) [[RFC5475](#)]) combined with the Alternate-Marking method for point-to-point flows. It is also called Mixed Hashed Marking: the coupling of a marking method and hashing technique is very useful, because the marking batches anchor the samples selected with hashing, and this simplifies the correlation of

the hashing packets along the path.

It is possible to use a basic-hash or a dynamic-hash method. One of the challenges of the basic approach is that the frequency of the sampled packets may vary considerably. For this reason, the dynamic approach has been introduced for point-to-point flows in order to have the desired and almost fixed number of samples for each measurement period. Using the hash-based sampling, the number of samples may vary a lot because it depends on the packet rate that is variable. The dynamic approach helps to have an almost fixed number of samples for each marking period, and this is a better option for making regular measurements over time. In the hash-based sampling, Alternate Marking is used to create periods, so that hash-based samples are divided into batches, which allows anchoring the selected samples to their period. Moreover, in the dynamic hash-based

sampling, by dynamically adapting the length of the hash value, the number of samples is bounded in each marking period.

In a multipoint environment, the hashing selection MAY be the solution for performing delay measurements on specific packets and overcoming the single- and double-marking limitations.

## [8.](#) Synchronization and Timing

It is important to consider the timing aspects, since out-of-order packets happen and have to be handled as well, as described in [\[I-D.fioccola-rfc8321bis\]](#).

However, in a multisource situation, an additional issue has to be considered. With multipoint path, the egress nodes will receive alternate marked packets in random order from different ingress nodes, and this must not affect the measurement.

So, if we analyze a multipoint-to-multipoint path with more than one marking node, it is important to recognize the reference measurement interval. In general, the measurement interval for describing the results is the interval of the marking node that is more aligned with the start of the measurement, as reported in Figure 4.

Note that the mark switching approach based on a fixed timer is considered in this document.

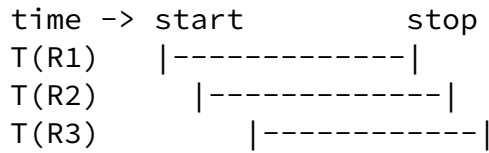
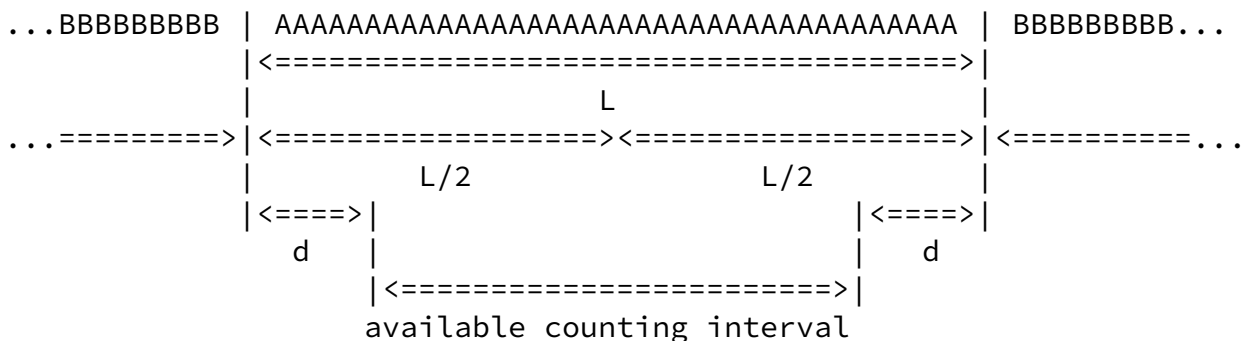

Figure 4: Measurement Interval

In Figure 4, it is assumed that the node with the earliest clock (R1) identifies the right starting and ending times of the measurement, but it is just an assumption, and other possibilities could occur. So, in this case, T(R1) is the measurement interval, and its recognition is essential in order to make comparisons with other active/passive/hybrid Packet Loss metrics.

Regarding the timing constraints of the methodology, [I-D.fioccola-rfc8321bis] already describes two contributions that are taken into account: the clock error between network devices and the network delay between the measurement points.

When we expand to a multipoint environment, we have to consider that there are more marking nodes that mark the traffic based on synchronized clock time. But, due to different synchronization issues that may happen, the marking batches can be of different lengths and with different offsets when they get mixed in a multipoint flow. The additional gap that results between the sources can be incorporated into A, which is the maximum clock skew between the network devices, as already defined in [I-D.fioccola-rfc8321bis].



## Figure 5: Timing Aspects

Moreover, it is assumed that each path of the multipoint flow can still be represented with a distinct normal distribution. So, for the aggregate multipoint path, the combination of normal distributions result in a new normal distribution. Under this assumption, the definition of the guard band  $d$  is still applicable as defined in [[I-D.fioccola-rfc8321bis](#)] and is given by:

$$d = A + D_{avg} + 3 * D_{stddev},$$

where  $A$  is the clock accuracy,  $D_{avg}$  is the average value of the network delay, and  $D_{stddev}$  is the standard deviation of the delay.

As shown in Figure 5 and according to [[I-D.fioccola-rfc8321bis](#)], the condition that must be satisfied to enable the method to function properly is that the available counting interval must be  $> 0$ , and that means:

$$L - 2d > 0.$$

This formula needs to be verified for each measurement point on the multipoint path.

Note that the timing considerations are valid for both packet loss and delay measurements.

### 9. Results of the Multipoint Alternate Marking Experiment

The methodology described in the previous sections can be applied to various performance measurement problems, as also explained in [[I-D.fioccola-rfc8321bis](#)].

Either one or two flag bits might be available for marking in different deployments:

One flag: packet loss measurement SHOULD be done as described in [Section 6](#) by applying the network clustering partition described in [Section 5](#). While delay measurement MAY be done according to

the Mean delay calculation representative of the multipoint path, as described in [Section 7.1.1](#). Single-marking method based on the first/last packet of the interval cannot be applied, as mentioned in [Section 7.2.1](#).

Two flags: packet loss measurement SHOULD be done as described in [Section 6](#) by applying the network clustering partition described in [Section 5](#). While delay measurement SHOULD be done on a single packet basis according to double-marking method [Section 7.2.1](#). In this case the Mean delay calculation ([Section 7.1.1](#)) MAY also be used as a representative value of a multipoint path.

One flag and hash-based selection: packet loss measurement SHOULD be done as described in [Section 6](#) by applying the network clustering partition described in [Section 5](#). Hash-based selection methodologies, introduced in [Section 7.2.2](#), MAY be used for delay measurement.

The experiment with Multipoint Alternate Marking methodologies confirmed the benefits of the Alternate Marking methodology described in [[I-D.fioccola-rfc8321bis](#)], as its extension to the general case of multipoint-to-multipoint scenarios.

The Multipoint Alternate Marking Method is RECOMMENDED only for controlled domains, as per [[I-D.fioccola-rfc8321bis](#)].

## 10. A Closed-Loop Performance-Management Approach

The Multipoint Alternate-Marking framework that is introduced in this document adds flexibility to Performance Management (PM), because it can reduce the order of magnitude of the packet counters. This allows an SDN orchestrator to supervise, control, and manage PM in large networks.

The monitoring network can be considered as a whole or split into clusters that are the smallest subnetworks (group-to-group segments),

maintaining the packet-loss property for each subnetwork. The clusters can also be combined in new, connected subnetworks at different levels, depending on the detail we want to achieve.

An SDN controller or a Network Management System (NMS) can calibrate



performance measurements, since they are aware of the network topology. They can start without examining in depth. In case of necessity (packet loss is measured or the delay is too high), the filtering criteria could be immediately reconfigured in order to perform a partition of the network by using clusters and/or different combinations of clusters. In this way, the problem can be localized in a specific cluster or a single combination of clusters, and a more detailed analysis can be performed step by step by successive approximation up to a point-to-point flow detailed analysis. This is the so-called "closed loop".

This approach can be called "network zooming" and can be performed in two different ways:

- 1) change the traffic filter and select more detailed flows;
- 2) activate new measurement points by defining more specified clusters.

The network-zooming approach implies that some filters or rules are changed and that therefore there is a transient time to wait once the new network configuration takes effect. This time can be determined by the Network Orchestrator/Controller, based on the network conditions.

For example, if the network zooming identifies the performance problem for the traffic coming from a specific source, we need to recognize the marked signal from this specific source node and its relative path. For this purpose, we can activate all the available measurement points and better specify the flow filter criteria (i.e., 5-tuple). As an alternative, it can be enough to select packets from the specific source for delay measurements; in this case, it is possible to apply the hashing technique, as mentioned in the previous sections.

[I-D.song-opsawg-ifit-framework] defines an architecture where the centralized Data Collector and Network Management can apply the intelligent and flexible Alternate-Marking algorithm as previously described.

As for [[I-D.fioccola-rfc8321bis](#)], it is possible to classify the traffic and mark a portion of the total traffic. For each period, the packet rate and bandwidth are calculated from the number of

packets. In this way, the network orchestrator becomes aware if the traffic rate surpasses limits. In addition, more precision can be obtained by reducing the marking period; indeed, some implementations use a marking period of 1 sec or less.

In addition, an SDN controller could also collect the measurement history.

It is important to mention that the Multipoint Alternate Marking framework also helps Traffic Visualization. Indeed, this methodology is very useful for identifying which path or cluster is crossed by the flow.

## 11. Security Considerations

This document specifies a method of performing measurements that does not directly affect Internet security or applications that run on the Internet. However, implementation of this method must be mindful of security and privacy concerns, as explained in [[I-D.fioccola-rfc8321bis](#)].

## 12. IANA Considerations

This document has no IANA actions.

## 13. Contributors

Greg Mirsky  
Ericsson  
Email: [gregimirsky@gmail.com](mailto:gregimirsky@gmail.com)

Tal Mizrahi  
Huawei Technologies  
Email: [tal.mizrahi.phd@gmail.com](mailto:tal.mizrahi.phd@gmail.com)

Xiao Min  
ZTE Corp.  
Email: [xiao.min2@zte.com.cn](mailto:xiao.min2@zte.com.cn)

## 14. Acknowledgements

The authors would like to thank Martin Duke and Tommy Pauly for their assistance and their detailed and precious reviews.

Internet-Draft

ClustAltMark

April 2022

## 15. References

### 15.1. Normative References

[I-D.fioccola-rfc8321bis]

Fioccola, G., Cociglio, M., Mirsky, G., Mizrahi, T., and T. Zhou, "Alternate-Marking Method", [draft-fioccola-rfc8321bis-04](#) (work in progress), April 2022.

[RFC2119] Bradner, S., "Key words for use in RFCs to Indicate Requirement Levels", [BCP 14](#), [RFC 2119](#), DOI 10.17487/RFC2119, March 1997, <<https://www.rfc-editor.org/info/rfc2119>>.

[RFC5474] Duffield, N., Ed., Chiou, D., Claise, B., Greenberg, A., Grossglauser, M., and J. Rexford, "A Framework for Packet Selection and Reporting", [RFC 5474](#), DOI 10.17487/RFC5474, March 2009, <<https://www.rfc-editor.org/info/rfc5474>>.

[RFC5475] Zseby, T., Molina, M., Duffield, N., Niccolini, S., and F. Raspall, "Sampling and Filtering Techniques for IP Packet Selection", [RFC 5475](#), DOI 10.17487/RFC5475, March 2009, <<https://www.rfc-editor.org/info/rfc5475>>.

[RFC5644] Stephan, E., Liang, L., and A. Morton, "IP Performance Metrics (IPPM): Spatial and Multicast", [RFC 5644](#), DOI 10.17487/RFC5644, October 2009, <<https://www.rfc-editor.org/info/rfc5644>>.

[RFC8174] Leiba, B., "Ambiguity of Uppercase vs Lowercase in [RFC 2119](#) Key Words", [BCP 14](#), [RFC 8174](#), DOI 10.17487/RFC8174, May 2017, <<https://www.rfc-editor.org/info/rfc8174>>.

### 15.2. Informative References

[I-D.ietf-ippm-route]

Alvarez-Hamelin, J. I., Morton, A., Fabini, J., Pignataro, C., and R. Geib, "Advanced Unidirectional Route Assessment (AURA)", [draft-ietf-ippm-route-10](#) (work in progress), August 2020.

[I-D.mizrahi-ippm-marking]

Mizrahi, T., Fioccola, G., Cociglio, M., Chen, M., and G. Mirsky, "Marking Methods for Performance Measurement", [draft-mizrahi-ippm-marking-00](#) (work in progress), October 2021.

[I-D.song-opsawg-ifit-framework]

Song, H., Qin, F., Chen, H., Jin, J., and J. Shin, "A Framework for In-situ Flow Information Telemetry", [draft-song-opsawg-ifit-framework-17](#) (work in progress), February 2022.

[I-D.zhou-ippm-enhanced-alternate-marking]

Zhou, T., Fioccola, G., Liu, Y., Cociglio, M., Lee, S., and W. Li, "Enhanced Alternate Marking Method", [draft-zhou-ippm-enhanced-alternate-marking-09](#) (work in progress), February 2022.

[IEEE-ACM-ToN-MPNPM]

IEEE/ACM TRANSACTION ON NETWORKING, "Multipoint Passive Monitoring in Packet Networks", DOI 10.1109/TNET.2019.2950157, 2019.

[IEEE-Network-PNPM]

IEEE Network, "AM-PM: Efficient Network Telemetry using Alternate Marking", DOI 10.1109/MNET.2019.1800152, 2019.

[RFC7011]

Claise, B., Ed., Trammell, B., Ed., and P. Aitken, "Specification of the IP Flow Information Export (IPFIX) Protocol for the Exchange of Flow Information", STD 77, [RFC 7011](#), DOI 10.17487/RFC7011, September 2013, <<https://www.rfc-editor.org/info/rfc7011>>.

[RFC8889]

Fioccola, G., Ed., Cociglio, M., Sapio, A., and R. Sisto, "Multipoint Alternate-Marking Method for Passive and Hybrid Performance Monitoring", [RFC 8889](#), DOI 10.17487/RFC8889, August 2020, <<https://www.rfc-editor.org/info/rfc8889>>.

Changes from [RFC 8889](#) in [draft-fioccola-rfc8889bis-00](#) include:

- o Minor editorial changes
- o Removed section on "Examples of application"

Changes in [draft-fioccola-rfc8889bis-01](#) include:

- o Considerations on BUM traffic
- o Reference to RFC8321bis for the fragmentation part
- o Revised section on "Delay Measurements on a Single-Packet Basis"

Fioccola, et al.

Expires October 28, 2022

[Page 25]

---

Internet-Draft

ClustAltMark

April 2022

- o Revised section on "Timing Aspects"

Changes in [draft-fioccola-rfc8889bis-02](#) include:

- o Clarified the formula in the section on "Timing Aspects" to be aligned with [RFC 8321](#)
- o Considerations on two-way delay measurements in both sections [8.1](#) and 8.2 on delay measurements
- o Clarified in [section 4.1](#) on "Monitoring Network" that the description is done for one direction but it can easily be extended to all direction
- o New section on "Results of the Multipoint Alternate Marking Experiment"

Changes in [draft-fioccola-rfc8889bis-03](#) include:

- o Moved and renamed section on "Timing Aspects" as "Synchronization and Timing"
- o Renamed old section on "Multipoint Packet Loss" as "Network Packet Loss"
- o New section on "Multipoint Packet Loss Measurement"
- o Renamed section on "Multipoint Performance Measurement" as

"Extension of the Method to Multipoint Flows"

Changes in [draft-fioccola-rfc8889bis-04](#)/draft-ietf-ippm-rfc8889bis-00 include:

- o Revised [section 5.1](#) on "Algorithm for Clusters Partition"

Authors' Addresses

Giuseppe Fioccola (editor)  
Huawei Technologies  
Riesstrasse, 25  
Munich 80992  
Germany

Email: [giuseppe.fioccola@huawei.com](mailto:giuseppe.fioccola@huawei.com)

Fioccola, et al.

Expires October 28, 2022

[Page 26]

---

Internet-Draft

ClustAltMark

April 2022

Mauro Cociglio  
Telecom Italia  
Via Reiss Romoli, 274  
Torino 10148  
Italy

Email: [mauro.cociglio@telecomitalia.it](mailto:mauro.cociglio@telecomitalia.it)

Amedeo Sapiro  
Intel Corporation  
4750 Patrick Henry Dr.  
Santa Clara, CA 95054  
USA

Email: [amedeo.sapiro@intel.com](mailto:amedeo.sapiro@intel.com)

Riccardo Sisto  
Politecnico di Torino  
Corso Duca degli Abruzzi, 24

Torino 10129  
Italy

Email: [riccardo.sisto@polito.it](mailto:riccardo.sisto@polito.it)

Tianran Zhou  
Huawei Technologies  
156 Beiqing Rd.  
Beijing 100095  
China

Email: [zhoutianran@huawei.com](mailto:zhoutianran@huawei.com)