

Mobile Ad hoc Networks Working Group
Internet-Draft
Intended status: Standards Track
Expires: January 26, 2017

S. Ratliff
VT iDirect
S. Jury
Cisco Systems
D. Satterwhite
Broadcom
R. Taylor
Airbus Defence & Space
B. Berry
July 25, 2016

Dynamic Link Exchange Protocol (DLEP)
draft-ietf-manet-dlep-24

Abstract

When routing devices rely on modems to effect communications over wireless links, they need timely and accurate knowledge of the characteristics of the link (speed, state, etc.) in order to make routing decisions. In mobile or other environments where these characteristics change frequently, manual configurations or the inference of state through routing or transport protocols does not allow the router to make the best decisions. A bidirectional, event-driven communication channel between the router and the modem is necessary.

Status of This Memo

This Internet-Draft is submitted in full conformance with the provisions of [BCP 78](#) and [BCP 79](#).

Internet-Drafts are working documents of the Internet Engineering Task Force (IETF). Note that other groups may also distribute working documents as Internet-Drafts. The list of current Internet-Drafts is at <http://datatracker.ietf.org/drafts/current/>.

Internet-Drafts are draft documents valid for a maximum of six months and may be updated, replaced, or obsoleted by other documents at any time. It is inappropriate to use Internet-Drafts as reference material or to cite them other than as "work in progress."

This Internet-Draft will expire on January 26, 2017.

Copyright Notice

Copyright (c) 2016 IETF Trust and the persons identified as the document authors. All rights reserved.

This document is subject to [BCP 78](http://trustee.ietf.org/license-info) and the IETF Trust's Legal Provisions Relating to IETF Documents (<http://trustee.ietf.org/license-info>) in effect on the date of publication of this document. Please review these documents carefully, as they describe your rights and restrictions with respect to this document. Code Components extracted from this document must include Simplified BSD License text as described in Section 4.e of the Trust Legal Provisions and are provided without warranty as described in the Simplified BSD License.

Table of Contents

1.	Introduction	4
2.	Protocol Overview	7
2.1.	Destinations	8
3.	Extensions	9
3.1.	Requirements	9
4.	Metrics	10
5.	DLEP Session Flow	11
5.1.	Peer Discovery State	11
5.2.	Session Initialization State	12
5.3.	In-Session State	13
5.3.1.	Heartbeats	13
5.4.	Session Termination State	14
5.5.	Session Reset state	14
5.5.1.	Unexpected TCP connection termination	14
6.	Transaction Model	15
7.	Extensions	15
7.1.	Experiments	16
8.	Scalability	16
9.	DLEP Signal and Message Structure	17
9.1.	DLEP Signal Header	17
9.2.	DLEP Message Header	18
9.3.	DLEP Generic Data Item	18
10.	DLEP Signals and Messages	19
10.1.	General Processing Rules	19
10.2.	Status code processing	20
10.3.	Peer Discovery Signal	20
10.4.	Peer Offer Signal	21
10.5.	Session Initialization Message	21
10.6.	Session Initialization Response Message	22
10.7.	Session Update Message	24
10.8.	Session Update Response Message	25

10.9.	Session Termination Message	25
10.10.	Session Termination Response Message	25
10.11.	Destination Up Message	26
10.12.	Destination Up Response Message	27
10.13.	Destination Announce Message	28
10.14.	Destination Announce Response Message	28
10.15.	Destination Down Message	30
10.16.	Destination Down Response Message	30
10.17.	Destination Update Message	31
10.18.	Link Characteristics Request Message	32
10.19.	Link Characteristics Response Message	33
10.20.	Heartbeat Message	34
11.	DLEP Data Items	34
11.1.	Status	35
11.2.	IPv4 Connection Point	37
11.3.	IPv6 Connection Point	38
11.4.	Peer Type	39
11.5.	Heartbeat Interval	40
11.6.	Extensions Supported	41
11.7.	MAC Address	41
11.8.	IPv4 Address	42
11.9.	IPv6 Address	43
11.10.	IPv4 Attached Subnet	44
11.11.	IPv6 Attached Subnet	45
11.12.	Maximum Data Rate (Receive)	46
11.13.	Maximum Data Rate (Transmit)	46
11.14.	Current Data Rate (Receive)	47
11.15.	Current Data Rate (Transmit)	48
11.16.	Latency	48
11.17.	Resources	49
11.18.	Relative Link Quality (Receive)	50
11.19.	Relative Link Quality (Transmit)	51
11.20.	Maximum Transmission Unit (MTU)	52
12.	Security Considerations	52
13.	IANA Considerations	53
13.1.	Registrations	53
13.2.	Signal Type Registration	53
13.3.	Message Type Registration	53
13.4.	DLEP Data Item Registrations	54
13.5.	DLEP Status Code Registrations	55
13.6.	DLEP Extensions Registrations	56
13.7.	DLEP Well-known Port	56
13.8.	DLEP IPv4 Link-local Multicast Address	57
13.9.	DLEP IPv6 Link-local Multicast Address	57
14.	Acknowledgements	57
15.	References	57
15.1.	Normative References	57
15.2.	Informative References	57

Appendix A . Discovery Signal Flows	58
Appendix B . Peer Level Message Flows	59
B.1 . Session Initialization	59
B.2 . Session Initialization - Refused	59
B.3 . Router Changes IP Addresses	60
B.4 . Modem Changes Session-wide Metrics	60
B.5 . Router Terminates Session	61
B.6 . Modem Terminates Session	61
B.7 . Session Heartbeats	62
B.8 . Router Detects a Heartbeat timeout	63
B.9 . Modem Detects a Heartbeat timeout	64
Appendix C . Destination Specific Message Flows	64
C.1 . Common Destination Notification	64
C.2 . Multicast Destination Notification	65
C.3 . Link Characteristics Request	66
Authors' Addresses	67

1. Introduction

There exist today a collection of modem devices that control links of variable datarate and quality. Examples of these types of links include line-of-sight (LOS) terrestrial radios, satellite terminals, and broadband modems. Fluctuations in speed and quality of these links can occur due to configuration, or on a moment-to-moment basis, due to physical phenomena like multipath interference, obstructions, rain fade, etc. It is also quite possible that link quality and datarate vary with respect to individual destinations on a link, and with the type of traffic being sent. As an example, consider the case of an IEEE 802.11 access point, serving two associated laptop computers. In this environment, the answer to the question "What is the datarate on the 802.11 link?" is "It depends on which associated laptop we're talking about, and on what kind of traffic is being sent." While the first laptop, being physically close to the access point, may have a datarate of 54Mbps for unicast traffic, the other laptop, being relatively far away, or obstructed by some object, can simultaneously have a datarate of only 32Mbps for unicast. However, for multicast traffic sent from the access point, all traffic is sent at the base transmission rate (which is configurable, but depending on the model of the access point, is usually 24Mbps or less).

In addition to utilizing variable datarate links, mobile networks are challenged by the notion that link connectivity will come and go over time, without an effect on a router's interface state (Up or Down). Effectively utilizing a relatively short-lived connection is problematic in IP routed networks, as IP routing protocols tend to rely on interface state and independent timers to maintain network convergence (e.g., HELLO messages and/or recognition of DEAD routing adjacencies). These dynamic connections can be better utilized with

an event-driven paradigm, where acquisition of a new neighbor (or loss of an existing one) is signaled, as opposed to a paradigm driven by timers and/or interface state. DLEP not only implements such an event-driven paradigm, but does so over a local (1 hop) TCP session, which guarantees delivery of the event messages.

Another complicating factor for mobile networks are the different methods of physically connecting the modem devices to the router. Modems can be deployed as an interface card in a router's chassis, or as a standalone device connected to the router via Ethernet or serial link. In the case of Ethernet attachment, with existing protocols and techniques, routing software cannot be aware of convergence events occurring on the radio link (e.g., acquisition or loss of a potential routing neighbor), nor can the router be aware of the actual capacity of the link. This lack of awareness, along with the variability in datarate, leads to a situation where finding the (current) best route through the network to a given node is difficult to establish and properly maintain. This is especially true of demand-based access schemes such as Demand Assigned Multiple Access (DAMA) implementations used on some satellite systems. With a DAMA-based system, additional datarate may be available, but will not be used unless the network devices emit traffic at a rate higher than the currently established rate. Increasing the traffic rate does not guarantee additional datarate will be allocated; rather, it may result in data loss and additional retransmissions on the link.

Addressing the challenges listed above, the Dynamic Link Exchange Protocol, or DLEP, has been developed. The DLEP protocol runs between a router and its attached modem devices, allowing the modem to communicate link characteristics as they change, and convergence events (acquisition and loss of potential routing next-hops). The following diagrams are used to illustrate the scope of DLEP packets.

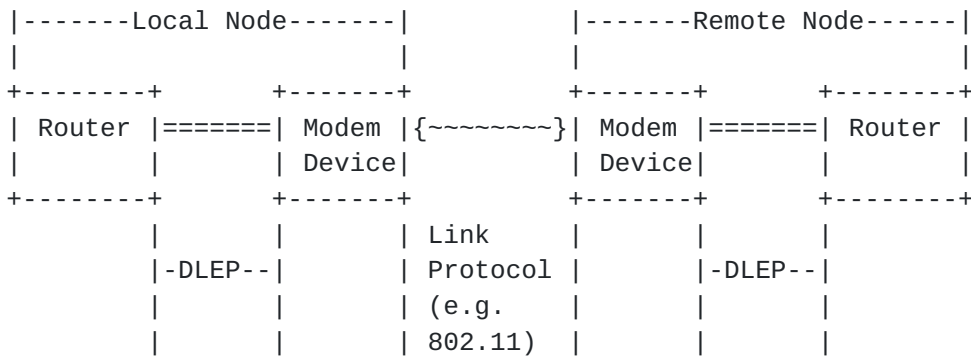

Figure 1: DLEP Network

In Figure 1, when the local modem detects the presence of a remote node, it (the local modem) sends a message to its router via the DLEP

protocol. The message consists of an indication of what change has occurred on the link (e.g., presence of a remote node detected), along with a collection of DLEP-defined data items that further describe the change. Upon receipt of the message, the local router may take whatever action it deems appropriate, such as initiating discovery protocols, and/or issuing HELLO messages to converge the network. On a continuing, as-needed basis, the modem devices use DLEP to report any characteristics of the link (datarate, latency, etc.) that have changed. DLEP is independent of the link type and topology supported by the modem. Note that the DLEP protocol is specified to run only on the local link between router and modem. Some over the air signaling may be necessary between the local and remote modem in order to provide some parameters in DLEP messages between the local modem and local router, but DLEP does not specify how such over the air signaling is carried out. Over the air signaling is purely a matter for the modem implementer.

Figure 2 shows how DLEP can support a configuration where routers are connected with different link types. In this example, Modem A implements a point-to-point link, and Modem B is connected via a shared medium. In both cases, the DLEP protocol is used to report the characteristics of the link (datarate, latency, etc.) to routers. The modem is also able to use the DLEP session to notify the router when the remote node is lost, shortening the time required to re-converge the network.

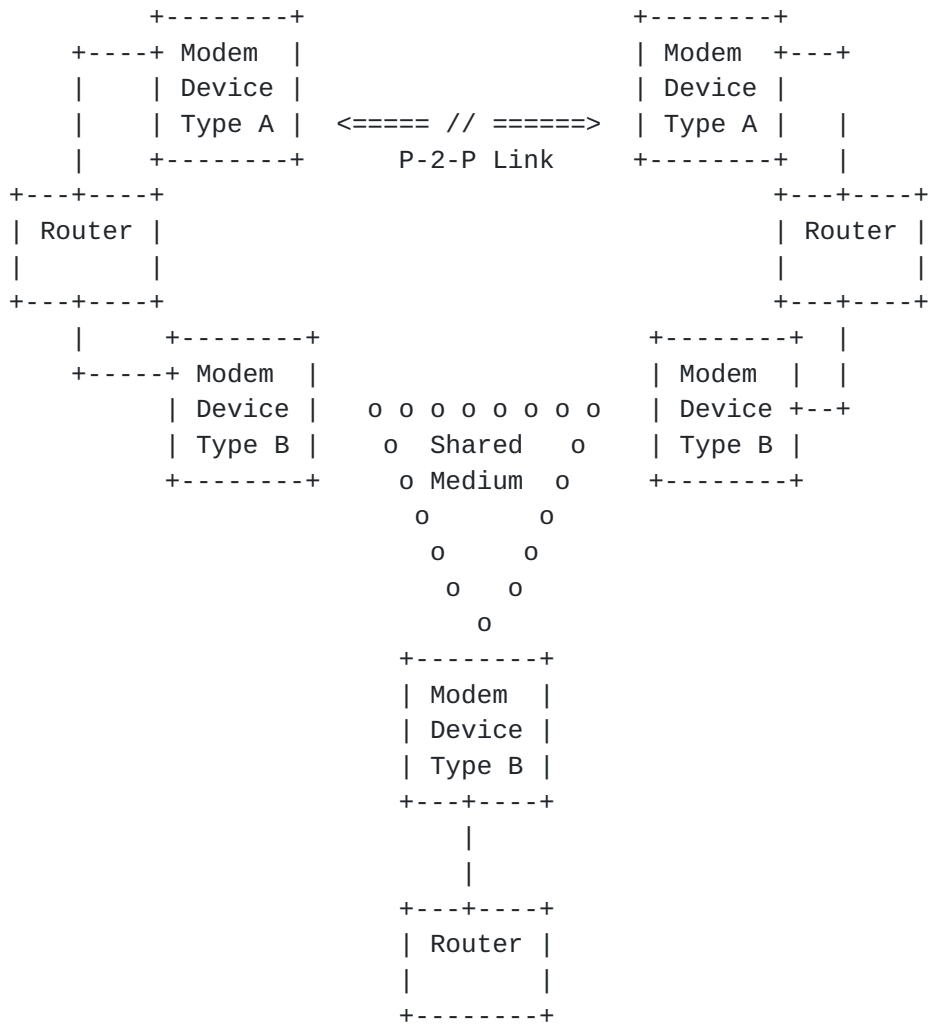

Figure 2: DLEP Network with Multiple Modem Devices

2. Protocol Overview

DLEP defines a set of Messages used by modems and their attached routers to communicate events that occur on the physical link(s) managed by the modem: for example, a remote node entering or leaving the network, or that the link has changed. Associated with these Messages are a set of Data Items - information that describes the remote node (e.g., address information), and/or the characteristics of the link to the remote node. Throughout this document, we refer to a modems/routers participating in a DLEP session as 'DLEP Participants', unless a specific distinction (e.g. modem or router) is required.

DLEP uses a session-oriented paradigm between the modem device and its associated router. If multiple modem devices are attached to a router (as in Figure 2), or the modem supports multiple connections

(via multiple logical or physical interfaces), then separate DLEP sessions exist for each modem or connection. A router and modem form a session by completing the discovery and initialization process. This router-modem session persists unless or until it either (1) times out, based on the absence of DLEP traffic (including heartbeats), or (2) is explicitly torn down by one of the DLEP participants.

2.1. Destinations

The router/modem session provides a carrier for information exchange concerning 'destinations' that are available via the modem device. Destinations can be identified by either the router or the modem, and represent a specific, addressable location that can be reached via the link(s) managed by the modem.

The DLEP Messages concerning destinations thus become the way for routers and modems to maintain, and notify each other about, an information base representing the physical and logical destinations accessible via the modem device, as well as the link characteristics to those destinations.

A destination can be either physical or logical. The example of a physical destination would be that of a remote, far-end router attached via the variable-quality network. It should be noted that for physical destinations the MAC address is the address of the far-end router, not the modem.

The example of a logical destination is Multicast. Multicast traffic destined for the variable-quality network (the network accessed via the modem) is handled in IP networks by deriving a Layer 2 MAC address based on the Layer 3 address. Leveraging on this scheme, multicast traffic is supported in DLEP simply by treating the derived MAC address as any other destination in the network.

To support these logical destinations, one of the DLEP participants (typically, the router) informs the other as to the existence of the logical destination. The modem, once it is aware of the existence of this logical destination, reports link characteristics just as it would for any other destination in the network. The specific algorithms a modem would use to derive metrics on logical destinations are outside the scope of this specification, and is left to specific implementations to decide.

In all cases, when this specification uses the term destination, it refers to the addressable locations, either logical or physical, that are accessible by the radio link(s).

3. Extensions

While this document represents the best efforts of the working group to be functionally complete, it is recognized that extensions to DLEP will in all likelihood be necessary as more link types are used. Such extensions are defined as additional Messages, Data Items and/or status codes, and associated rules of behavior, that are not defined in this document. DLEP contains a standard mechanism for router and modem implementations to negotiate the available extensions to use on a per-session basis.

3.1. Requirements

The key words "MUST", "MUST NOT", "REQUIRED", "SHALL", "SHALL NOT", "SHOULD", "SHOULD NOT", "RECOMMENDED", "NOT RECOMMENDED", "MAY", and "OPTIONAL" in this document are to be interpreted as described in [BCP 14](#), [RFC 2119](#) [[RFC2119](#)].

DLEP MUST be implemented on a single Layer 2 domain. The protocol identifies next-hop destinations by using the MAC address for delivering data traffic. No manipulation or substitution is performed; the MAC address supplied in all DLEP Messages is used as the Destination MAC address for frames emitted by the participating router. MAC addresses MUST be unique within the context of router-modem session.

DLEP specifies UDP multicast for single-hop discovery signaling, and TCP for transport of the Messages. Modems and routers participating in DLEP sessions MUST have topologically consistent IP addresses assigned. It is RECOMMENDED that DLEP implementations utilize IPv6 link-local addresses to reduce the administrative burden of address assignment.

To enforce the single Layer 2 domain for DLEP Messages, implementations MUST adhere to the Generalized TTL Security Mechanism documented in [[RFC5082](#)] for all TCP-based DLEP Messages.

In order to keep the DLEP discovery Signals, which are multicast UDP-based, limited to the same Layer 2 domain, implementations MUST set the TTL of all DLEP Signals to 1, and MUST check for TTL = 1 on receipt of DLEP Signals. Any signal received with a TTL not equal to 1 MUST be discarded.

DLEP relies on the guaranteed delivery of its Messages between router and modem, once the 1 hop discovery process is complete, hence, the specification of TCP to carry the Messages. Other reliable transports for the protocol are possible, but are outside the scope of this document.

DLEP further requires that security of the implementations (e.g., authentication of stations, encryption of traffic, or both) is dealt with by utilizing Layer 2 security techniques. This reliance on Layer 2 mechanisms secures all DLEP Messages - both the UDP discovery Signals and the TCP control Messages.

4. Metrics

DLEP includes the ability for the router and modem to communicate metrics that reflect the characteristics (e.g., datarate, latency) of the variable-quality link in use. DLEP does not specify how a given metric value is to be calculated, rather, the protocol assumes that metrics have been calculated by a 'best effort', incorporating all pertinent data that is available to the modem device. Metrics based on large enough sample sizes will preclude short traffic bursts from adversely skewing reported values.

DLEP allows for metrics to be sent within two contexts - metrics for a specific destination within the network (e.g., a specific router), and per-session (those that apply to all destinations accessed via the modem). Most metrics can be further subdivided into transmit and receive metrics. In cases where metrics are provided at session level, the router propagates the metrics to all entries in its information base for destinations that are accessed via the modem.

DLEP modems announce all metric Data Items that will be reported during the session, and provide default values for those metrics, in the Session Initialization Response Message ([Section 10.6](#)). In order to use a metric type that was not included in the Session Initialization Response Message, modem implementations terminate the session with the router (via the Session Terminate Message ([Section 10.9](#))), and establish a new session.

A DLEP modem can send metrics both in a session context, via the Session Update Message ([Section 10.7](#)), and a specific destination context, via the Destination Update Message ([Section 10.17](#)), at any time. The most recently received metric value takes precedence over any earlier value, regardless of context - that is:

1. If the router receives metrics in a specific destination context (via the Destination Update Message), then the specific destination is updated with the new metric.
2. If the router receives metrics in a session-wide context (via the Session Update Message), then the metrics for all destinations accessed via the modem are updated with the new metric.

It is left to implementations to choose sensible default values based on their specific characteristics. Modems having static (non-changing) link metric characteristics can report metrics only once for a given destination (or once on a session-wide basis, if all connections via the modem are of this static nature).

In addition to communicating existing metrics about the link, DLEP provides a Message allowing a router to request a different datarate or latency from the modem. This Message is the Link Characteristics Request Message ([Section 10.18](#)), and gives the router the ability to deal with requisite increases (or decreases) of allocated datarate/latency in demand-based schemes in a more deterministic manner.

5. DLEP Session Flow

All DLEP participants of a session transition through a number of distinct states during the lifetime of a DLEP session:

- o Peer Discovery
- o Session Initialization
- o In-Session
- o Session Termination
- o Session Reset

Modems, and routers supporting DLEP discovery, transition through all five (5) of the above states. Routers that rely on preconfigured TCP address/port information start in the Session Initialization state.

Modems MUST support the Peer Discovery state.

5.1. Peer Discovery State

In the Peer Discovery state, routers that support DLEP discovery MUST send Peer Discovery Signals ([Section 10.3](#)) to initiate modem discovery.

The router implementation then waits for a Peer Offer Signal ([Section 10.4](#)) response from a potential DLEP modem. While in the Peer Discovery state, Peer Discovery Signals MUST be sent repeatedly by a DLEP router, at regular intervals. The interval MUST be a minimum of one second; it SHOULD be a configurable parameter. Note that this operation (sending Peer Discovery and waiting for Peer Offer) is outside the DLEP Transaction Model ([Section 6](#)), as the Transaction Model only describes Messages on a TCP session.

Routers MUST use one or more of each of the modem address/port combinations from the Peer Offer Signal or, when no Connection Point Data Items are present, from a priori configuration to establish a new TCP connection to the modem. If more than one modem address/port combinations is provided, router implementations MAY use their own heuristics to determine the order in which they are tried. If a TCP connection cannot be achieved using any of the address/port combinations and the Discovery mechanism is in use, then the router SHOULD resume issuing Peer Discovery Signals. If no Connection Point Data Items are included in the Peer Offer Signal, the router MUST use the source address of the UDP packet containing the Peer Offer Signal as the IP address, and the DLEP well-known port number.

In the Peer Discovery state, the modem implementation MUST listen for incoming Peer Discovery Signals on the DLEP well-known IPv6 and/or IPv4 link-local multicast address and port. On receipt of a valid Peer Discovery Signal, it MUST reply with a Peer Offer Signal.

Modems MUST be prepared to accept a TCP connection from a router that is not using the Discovery mechanism, i.e. a connection attempt that occurs without a preceding Peer Discovery Signal.

Upon establishment of a TCP connection, both modem and router enter the Session Initialization state. It is up to the router implementation if Peer Discovery Signals continue to be sent after the device has transitioned to the Session Initialization state. Modem implementations MUST silently ignore Peer Discovery Signals from a router with which it already has a TCP connection.

5.2. Session Initialization State

On entering the Session Initialization state, the router MUST send a Session Initialization Message ([Section 10.5](#)) to the modem. The router MUST then wait for receipt of a Session Initialization Response Message ([Section 10.6](#)) from the modem. Receipt of the Session Initialization Response Message containing a Status Data Item ([Section 11.1](#)) with status code set to 0 'Success', see Table 2, indicates that the modem has received and processed the Session Initialization Message, and the router MUST transition to the In-Session state.

On entering the Session Initialization state, the modem MUST wait for receipt of a Session Initialization Message from the router. Upon receipt of a Session Initialization Message, the modem MUST send a Session Initialization Response Message, and the session MUST transition to the In-Session state. If the modem receives any Message other than Session Initialization, or it fails to parse the

received Message, it MUST NOT send any Message, and MUST terminate the TCP connection and transition to the Session Reset state.

DLEP provides an extension negotiation capability to be used in the Session Initialization state, see [Section 3](#). Extensions supported by an implementation MUST be declared to potential DLEP participants using the Extensions Supported Data Item ([Section 11.6](#)). Once both DLEP participants have exchanged initialization Messages, an implementation MUST NOT emit any Message, Signal, Data Item or status code associated with an extension that was not specified in the received initialization Message from its peer.

[5.3](#). In-Session State

In the In-Session state, Messages can flow in both directions between DLEP participants, indicating changes to the session state, the arrival or departure of reachable destinations, or changes of the state of the links to the destinations.

The In-Session state is maintained until one of the following conditions occur:

- o The implementation terminates the session by sending a Session Termination Message ([Section 10.9](#)), or,
- o Its peer terminates the session, indicated by receiving a Session Termination Message.

The implementation MUST then transition to the Session Termination state.

[5.3.1](#). Heartbeats

In order to maintain the In-Session state, periodic Heartbeat Messages ([Section 10.20](#)) MUST be exchanged between router and modem. These Messages are intended to keep the session alive, and to verify bidirectional connectivity between the two DLEP participants.

Each DLEP participant is responsible for the creation of Heartbeat Messages.

Receipt of any valid DLEP Message MUST reset the heartbeat interval timer (i.e., valid DLEP Messages take the place of, and obviate the need for, additional Heartbeat Messages).

Implementations MUST allow a minimum of two (2) heartbeat intervals to expire with no Messages from its peer before terminating the session. When terminating the session, a Session Termination Message

containing a Status Data Item ([Section 11.1](#)) with status code set to 132 'Timed Out', see Table 2, MUST be sent, and then the implementation MUST transition to the Session Termination state.

5.4. Session Termination State

When an implementation enters the Session Termination state after sending a Session Termination Message ([Section 10.9](#)) as the result of an invalid Message or error, it MUST wait for a Session Termination Response Message ([Section 10.10](#)) from its peer. Senders SHOULD allow four (4) heartbeat intervals to expire before assuming that its peer is unresponsive, and continuing with session termination. Any other Message received while waiting MUST be silently ignored.

When the sender of the Session Termination Message receives a Session Termination Response Message from its peer, or times out, it MUST transition to the Session Reset state.

When an implementation receives a Session Termination Message from its peer, it enters the Session Termination state and then it MUST immediately send a Session Termination Response and transition to the Session Reset state.

5.5. Session Reset state

In the Session Reset state the implementation MUST perform the following actions:

- o Release all resources allocated for the session.
- o Eliminate all destinations in the information base represented by the session. Destination Down Messages ([Section 10.15](#)) MUST NOT be sent.
- o Terminate the TCP connection.

Having completed these actions the implementation SHOULD return to the relevant initial state: Peer Discovery for modems; either Peer Discovery or Session Initialization for routers, depending on configuration.

5.5.1. Unexpected TCP connection termination

If the TCP connection between DLEP participants is terminated when an implementation is not in the Session Reset state, the implementation MUST immediately transition to the Session Reset state.

6. Transaction Model

DLEP defines a simple Message transaction model: Only one request per destination may be in progress at a time per session. A Message transaction is considered complete when a response matching a previously issued request is received. If a DLEP participant receives a request for a destination for which there is already an outstanding request, the implementation MUST terminate the session by issuing a Session Termination Message ([Section 10.9](#)) containing a Status Data Item ([Section 11.1](#)) with status code set to 129 'Unexpected Message', see Table 2, and transition to the Session Termination state. There is no restriction to the total number of Message transactions in progress at a time, as long as each transaction refers to a different destination.

It should be noted that some requests may take a considerable amount of time for some DLEP participants to complete, for example a modem handling a multicast destination up request may have to perform a complex network reconfiguration. A sending implementation MUST be able to handle such long running transactions gracefully.

Additionally, only one session request, e.g. a Session Initialization Message ([Section 10.5](#)), may be in progress at a time per session. As above, a session transaction is considered complete when a response matching a previously issued request is received. If a DLEP participant receives a session request while there is already a session request in progress, it MUST terminate the session by issuing a Session Termination Message containing a Status Data Item with status code set to 129 'Unexpected Message', and transition to the Session Termination state. Only the Session Termination Message may be issued when a session transaction is in progress. Heartbeat Messages ([Section 10.20](#)) MUST NOT be considered part of a session transaction.

DLEP transactions do not time out and are not cancellable. An implementation can detect if its peer has failed in some way by use of the session heartbeat mechanism during the In-Session state, see [Section 5.3](#).

7. Extensions

Extensions MUST be negotiated on a per-session basis during session initialization via the Extensions Supported mechanism. Implementations are not required to support any extension in order to be considered DLEP compliant. An extension document, describing the operation of a credit windowing scheme for flow control, is described in [[CREDIT](#)].

If interoperable protocol extensions are required, they will need to be standardized either as an update to this document, or as an additional stand-alone specification. The requests for IANA-controlled registries in this document contain sufficient Reserved space for DLEP Signals, Messages, Data Items and status codes to accommodate future extensions to the protocol.

As multiple protocol extensions MAY be announced during session initialization, authors of protocol extensions need to consider the interaction of their extension with other published extensions, and specify any incompatibilities.

7.1. Experiments

This document requests Private Use numbering space in the DLEP Signal, Message, Data Item and status code registries for experimental extensions. The intent is to allow for experimentation with new Signals, Messages, Data Items, and/or status codes, while still retaining the documented DLEP behavior.

Use of the Private Use Signals, Messages, Data Items, status codes, or behaviors MUST be announced as DLEP Extensions, during session initialization, using extension identifiers from the Private Use space in the Extensions Supported registry (Table 3), with a value agreed upon (a priori) between the participants. DLEP extensions using the Private Use numbering space are commonly referred to as Experiments.

Multiple experiments MAY be announced in the Session Initialization Messages. However, use of multiple experiments in a single session could lead to interoperability issues or unexpected results (e.g., clashes of experimental Signals, Messages, Data Items and/or status code types), and is therefore discouraged. It is left to implementations to determine the correct processing path (e.g., a decision on whether to terminate the session, or to establish a precedence of the conflicting definitions) if such conflicts arise.

8. Scalability

The protocol is intended to support thousands of destinations on a given modem/router pair. At large scale, implementations SHOULD consider employing techniques to prevent flooding its peer with a large number of Messages in a short time. For example, a dampening algorithm could be employed to prevent a flapping device from generating a large number of Destination Up/Destination Down Messages.

Also, use of techniques such as a hysteresis can lessen the impact of rapid, minor fluctuations in link quality. The specific algorithms for handling flapping destinations and minor changes in link quality are outside the scope of this specification.

9. DLEP Signal and Message Structure

DLEP defines two protocol units used in two different ways: Signals and Messages. Signals are only used in the Discovery mechanism and are carried in UDP datagrams. Messages are used bi-directionally over a TCP connection between the participants, in the Session Initialization, In-Session and Session Termination states.

Both Signals and Messages consist of a Header followed by an unordered list of Data Items. Headers consist of Type and Length information, while Data Items are encoded as TLV (Type-Length-Value) structures. In this document, the Data Items following a Signal or Message Header are described as being 'contained in' the Signal or Message.

There is no restriction on the order of Data Items following a Header, and the acceptability of duplicate Data Items is defined by the definition of the Signal or Message declared by the type in the Header.

All integers in Header fields and values MUST be in network byte-order.

9.1. DLEP Signal Header

The DLEP Signal Header contains the following fields:

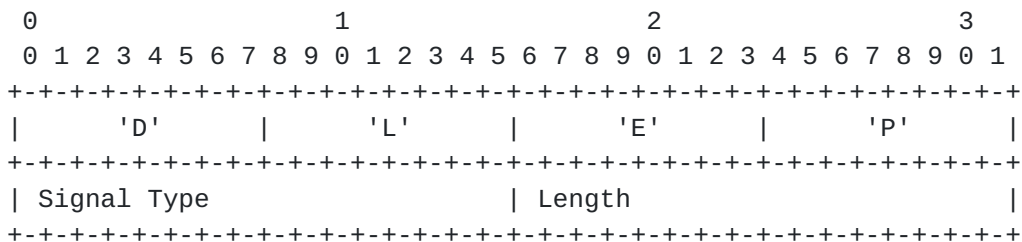

Figure 3: DLEP Signal Header

"DLEP": Every Signal MUST start with the characters: U+0044, U+004C, U+0045, U+0050.

Signal Type: A 16-bit unsigned integer containing one of the DLEP Signal Type values defined in this document.

Length: The length in octets, expressed as a 16-bit unsigned integer, of all of the DLEP Data Items contained in this Signal. This length MUST NOT include the length of the Signal Header itself.

The DLEP Signal Header is immediately followed by zero or more DLEP Data Items, encoded in TLVs, as defined in this document.

9.2. DLEP Message Header

The DLEP Message Header contains the following fields:

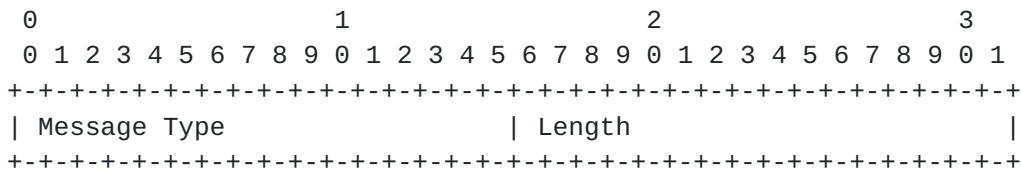

Figure 4: DLEP Message Header

Message Type: A 16-bit unsigned integer containing one of the DLEP Message Type values defined in this document.

Length: The length in octets, expressed as a 16-bit unsigned integer, of all of the DLEP Data Items contained in this Message. This length MUST NOT include the length of the Message Header itself.

The DLEP Message Header is immediately followed by zero or more DLEP Data Items, encoded in TLVs, as defined in this document.

9.3. DLEP Generic Data Item

All DLEP Data Items contain the following fields:

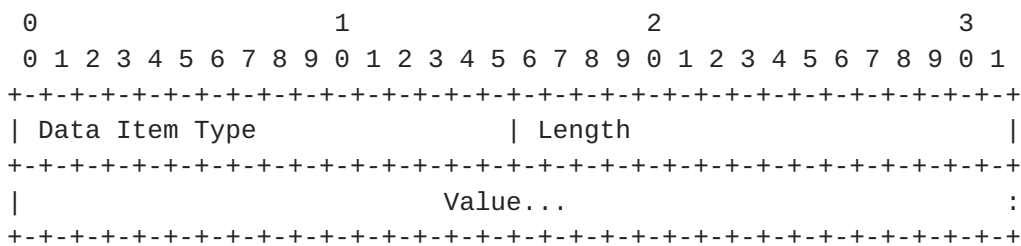

Figure 5: DLEP Generic Data Item

Data Item Type: A 16-bit unsigned integer field specifying the type of Data Item being sent.

Length: The length in octets, expressed as a 16-bit unsigned integer, of the Value field of the Data Item. This length MUST NOT include the length of the Data Item Type and Length fields.

Value: A field of <Length> octets, which contains data specific to a particular Data Item.

10. DLEP Signals and Messages

10.1. General Processing Rules

If an unrecognized, or unexpected Signal is received, or a received Signal contains unrecognized, invalid, or disallowed duplicate Data Items, the receiving implementation MUST ignore the Signal.

If a Signal is received with a TTL value that is NOT equal to 1, the receiving implementation MUST ignore the Signal.

If an unrecognized Message is received, the receiving implementation MUST issue a Session Termination Message ([Section 10.9](#)) containing a Status Data Item ([Section 11.1](#)) with status code set to 128 'Unknown Message', see Table 2, and transition to the Session Termination state.

If an unexpected Message is received, the receiving implementation MUST issue a Session Termination Message containing a Status Data Item with status code set to 129 'Unexpected Message', and transition to the Session Termination state.

If a received Message contains unrecognized, invalid, or disallowed duplicate Data Items, the receiving implementation MUST issue a Session Termination Message containing a Status Data Item with status code set to 130 'Invalid Data', and transition to the Session Termination state.

If a packet in the TCP stream is received with a TTL value other than 255, the receiving implementation MUST immediately transition to the Session Reset state.

Prior to the exchange of Destination Up ([Section 10.11](#)) and Destination Up Response ([Section 10.12](#)) Messages, or Destination Announce ([Section 10.13](#)) and Destination Announce Response ([Section 10.14](#)) Messages, no Messages concerning a destination may be sent. An implementation receiving any Message with such an unannounced destination MUST terminate the session by issuing a Session Termination Message containing a Status Data Item with status code set to 131 'Invalid Destination', and transition to the Session Termination state.

After exchanging Destination Down ([Section 10.15](#)) and Destination Down Response ([Section 10.16](#)) Messages, no Messages concerning a destination may be sent until a new Destination Up or Destination Announce Message is sent. An implementation receiving a Message about a destination previously announced as 'down' MUST terminate the session by issuing a Session Termination Message with a Status Data Item with status code set to 131 'Invalid Destination', and transition to the Session Termination state.

10.2. Status code processing

The behaviour of a DLEP participant receiving a Message containing a Status Data Item ([Section 11.1](#)) is defined by the failure mode associated with the value of the status code field, see Table 2. All status code values less than 100 have a failure mode of 'Continue', all other status codes have a failure mode of 'Terminate'.

A DLEP participant receiving any Message apart from Session Termination Message ([Section 10.9](#)) containing a Status Data Item with a status code value with failure mode 'Terminate' MUST immediately issue a Session Termination Message containing an identical Status Data Item, and then transition to the Session Termination state.

A DLEP participant receiving a Message containing a Status Data Item with a status code value with failure mode 'Continue' can continue normal operation of the session.

10.3. Peer Discovery Signal

A Peer Discovery Signal SHOULD be sent by a DLEP router to discover DLEP modems in the network, see [Section 5.1](#).

A Peer Discovery Signal MUST be encoded within a UDP packet. The destination MUST be set to the DLEP well-known address and port number. For routers supporting both IPv4 and IPv6 DLEP operation, it is RECOMMENDED that IPv6 be selected as the transport. The source IP address MUST be set to the router IP address associated with the DLEP interface. There is no DLEP-specific restriction on source port.

To construct a Peer Discovery Signal, the Signal Type value in the Signal Header is set to 1 (see Signal Type Registration ([Section 13.2](#))).

The Peer Discovery Signal MAY contain a Peer Type Data Item ([Section 11.4](#)).

10.4. Peer Offer Signal

A Peer Offer Signal MUST be sent by a DLEP modem in response to a properly formatted and addressed Peer Discovery Signal ([Section 10.3](#)).

A Peer Offer Signal MUST be encoded within a UDP packet. The IP destination MUST be set to the IP address and port number received in the corresponding Peer Discovery Signal. The source IP address MUST be set to the modem's IP address associated with the DLEP interface. The source port number MUST be set to the DLEP well-known port number. The Peer Offer Signal completes the discovery process, see [Section 5.1](#).

To construct a Peer Offer Signal, the Signal Type value in the Signal Header is set to 2 (see Signal Type Registration ([Section 13.2](#))).

The Peer Offer Signal MAY contain a Peer Type Data Item ([Section 11.4](#)).

The Peer Offer Signal MAY contain one or more of any of the following Data Items, with different values:

- o IPv4 Connection Point ([Section 11.2](#))
- o IPv6 Connection Point ([Section 11.3](#))

The IP Connection Point Data Items indicate the unicast address the router MUST use when connecting the DLEP TCP session.

10.5. Session Initialization Message

A Session Initialization Message MUST be sent by a DLEP router as the first Message of the DLEP TCP session. It is sent by the router after a TCP connect to an address/port combination that was obtained either via receipt of a Peer Offer, or from a priori configuration.

To construct a Session Initialization Message, the Message Type value in the Message Header is set to 1 (see Message Type Registration ([Section 13.3](#))).

The Session Initialization Message MUST contain a Heartbeat Interval Data Item ([Section 11.5](#)).

The Session Initialization Message MAY contain one of each of the following Data Items:

- o Peer Type ([Section 11.4](#))

- o Extensions Supported ([Section 11.6](#))

If any optional extensions are supported by the implementation, they MUST be enumerated in the Extensions Supported Data Item. If an Extensions Supported Data Item does not exist in a Session Initialization Message, the modem MUST conclude that there is no support for extensions in the router.

DLEP Heartbeats are not fully established until receipt of the Session Initialization Response Message ([Section 10.6](#)), and therefore implementations MUST use their own timeout and retry heuristics for this Message.

As an exception to the general rule governing an implementation receiving an unrecognized Data Item in a Message, see [Section 10.1](#), if a Session Initialization Message contains one or more Extension Supported Data Items announcing support for extensions that the implementation does not recognize, then the implementation MAY ignore Data Items it does not recognize.

[10.6](#). Session Initialization Response Message

A Session Initialization Response Message MUST be sent in response to a received Session Initialization Message ([Section 10.5](#)).

To construct a Session Initialization Response Message, the Message Type value in the Message Header is set to 2 (see Message Type Registration ([Section 13.3](#))).

The Session Initialization Response Message MUST contain one of each of the following Data Items:

- o Status ([Section 11.1](#))
- o Heartbeat Interval ([Section 11.5](#))
- o Maximum Data Rate (Receive) ([Section 11.12](#))
- o Maximum Data Rate (Transmit) ([Section 11.13](#))
- o Current Data Rate (Receive) ([Section 11.14](#))
- o Current Data Rate (Transmit) ([Section 11.15](#))
- o Latency ([Section 11.16](#))

The Session Initialization Response Message MUST contain one of each of the following Data Items, if the Data Item will be used during the lifetime of the session:

- o Resources ([Section 11.17](#))
- o Relative Link Quality (Receive) ([Section 11.18](#))
- o Relative Link Quality (Transmit) ([Section 11.19](#))
- o Maximum Transmission Unit (MTU) ([Section 11.20](#))

The Session Initialization Response Message MAY contain one of each of the following Data Items:

- o Peer Type ([Section 11.4](#))
- o Extensions Supported ([Section 11.6](#))

The Session Initialization Response Message completes the DLEP session establishment; the modem should transition to the In-Session state when the Message is sent, and the router should transition to the In-Session state upon receipt of an acceptable Session Initialization Response Message.

All supported metric Data Items MUST be included in the Session Initialization Response Message, with default values to be used on a session-wide basis. This can be viewed as the modem 'declaring' all supported metrics at DLEP session initialization. Receipt of any further DLEP Message containing a metric Data Item not included in the Session Initialization Response Message MUST be treated as an error, resulting in the termination of the DLEP session between router and modem.

If any optional extensions are supported by the modem, they MUST be enumerated in the Extensions Supported Data Item. If an Extensions Supported Data Item does not exist in a Session Initialization Response Message, the router MUST conclude that there is no support for extensions in the modem.

After the Session Initialization/Session Initialization Response Messages have been successfully exchanged, implementations MUST only use extensions that are supported by both DLEP participants, see [Section 5.2](#).

10.7. Session Update Message

A Session Update Message MAY be sent by a DLEP participant to indicate local Layer 3 address changes, or metric changes on a session-wide basis.

To construct a Session Update Message, the Message Type value in the Message Header is set to 3 (see Message Type Registration ([Section 13.3](#))).

The Session Update Message MAY contain one of each of the following Data Items:

- o Maximum Data Rate (Receive) ([Section 11.12](#))
- o Maximum Data Rate (Transmit) ([Section 11.13](#))
- o Current Data Rate (Receive) ([Section 11.14](#))
- o Current Data Rate (Transmit) ([Section 11.15](#))
- o Latency ([Section 11.16](#))

The Session Update Message MAY contain one of each of the following Data Items, if the Data Item is in use by the session:

- o Resources ([Section 11.17](#))
- o Relative Link Quality (Receive) ([Section 11.18](#))
- o Relative Link Quality (Transmit) ([Section 11.19](#))
- o Maximum Transmission Unit (MTU) ([Section 11.20](#))

The Session Update Message MAY contain one or more of each of the following Data Items, with different values:

- o IPv4 Address ([Section 11.8](#))
- o IPv6 Address ([Section 11.9](#))

If metrics are supplied with the Session Update Message (e.g., Maximum Data Rate), these metrics are considered to be session-wide, and therefore MUST be applied to all destinations in the information base associated with the DLEP session. This includes destinations for which metrics may have been stored based on received Destination Update messages.

It should be noted that Session Update Messages can be sent by both routers and modems. For example, addition of an IPv4 address to the router MAY prompt a Session Update Message to its attached modems. Also, for example, a modem that changes its Maximum Data Rate (Receive) for all destinations MAY reflect that change via a Session Update Message to its attached router(s).

Concerning Layer 3 addresses: If the modem is capable of understanding and forwarding this information (via proprietary mechanisms), the address update would prompt any remote DLEP modems (DLEP-enabled modems in a remote node) to issue a Destination Update Message ([Section 10.17](#)) to their local routers with the new (or deleted) addresses. Modems that do not track Layer 3 addresses SHOULD silently ignore Address Data Items.

[10.8.](#) Session Update Response Message

A Session Update Response Message MUST be sent by a DLEP participant when a Session Update Message ([Section 10.7](#)) is received.

To construct a Session Update Response Message, the Message Type value in the Message Header is set to 4 (see Message Type Registration ([Section 13.3](#))).

The Session Update Response Message MUST contain a Status Data Item ([Section 11.1](#)).

[10.9.](#) Session Termination Message

A Session Termination Message MUST be sent by a DLEP participant when the DLEP session needs to be terminated.

To construct a Session Termination Message, the Message Type value in the Message Header is set to 5 (see Message Type Registration ([Section 13.3](#))).

The Session Termination Message MUST contain Status Data Item ([Section 11.1](#)).

It should be noted that Session Termination Messages can be sent by both routers and modems.

[10.10.](#) Session Termination Response Message

A Session Termination Response Message MUST be sent by a DLEP participant when a Session Termination Message ([Section 10.9](#)) is received.

To construct a Session Termination Response Message, the Message Type value in the Message Header is set to 6 (see Message Type Registration ([Section 13.3](#))).

There are no valid Data Items for the Session Termination Response Message.

Receipt of a Session Termination Response Message completes the tear-down of the DLEP session, see [Section 5.4](#).

[10.11](#). Destination Up Message

Destination Up Messages MAY be sent by a modem to inform its attached router of the presence of a new reachable destination.

To construct a Destination Up Message, the Message Type value in the Message Header is set to 7 (see Message Type Registration ([Section 13.3](#))).

The Destination Up Message MUST contain a MAC Address Data Item ([Section 11.7](#)).

The Destination Up Message SHOULD contain one or more of each of the following Data Items, with different values:

- o IPv4 Address ([Section 11.8](#))
- o IPv6 Address ([Section 11.9](#))

The Destination Up Message MAY contain one of each of the following Data Items:

- o Maximum Data Rate (Receive) ([Section 11.12](#))
- o Maximum Data Rate (Transmit) ([Section 11.13](#))
- o Current Data Rate (Receive) ([Section 11.14](#))
- o Current Data Rate (Transmit) ([Section 11.15](#))
- o Latency ([Section 11.16](#))

The Destination Up Message MAY contain one of each of the following Data Items, if the Data Item is in use by the session:

- o Resources ([Section 11.17](#))
- o Relative Link Quality (Receive) ([Section 11.18](#))

- o Relative Link Quality (Transmit) ([Section 11.19](#))
- o Maximum Transmission Unit (MTU) ([Section 11.20](#))

The Destination Up Message MAY contain one or more of each of the following Data Items, with different values:

- o IPv4 Attached Subnet ([Section 11.10](#))
- o IPv6 Attached Subnet ([Section 11.11](#))

A router receiving a Destination Up Message allocates the necessary resources, creating an entry in the information base with the specifics (MAC Address, Latency, Data Rate, etc.) of the destination. The information about this destination will persist in the router's information base until a Destination Down Message ([Section 10.15](#)) is received, indicating that the modem has lost contact with the remote node, or the implementation transitions to the Session Termination state.

[10.12.](#) Destination Up Response Message

A router MUST send a Destination Up Response Message when a Destination Up Message ([Section 10.11](#)) is received.

To construct a Destination Up Response Message, the Message Type value in the Message Header is set to 8 (see Message Type Registration ([Section 13.3](#))).

The Destination Up Response Message MUST contain one of each of the following Data Items:

- o MAC Address ([Section 11.7](#))
- o Status ([Section 11.1](#))

A router that wishes to receive further information concerning the destination identified in the corresponding Destination Up Message MUST set the status code of the included Status Data Item to 0 'Success', see Table 2.

If the router has no interest in the destination identified in the corresponding Destination Up Message, then it MAY set the status code of the included Status Data Item to 1 'Not Interested'.

A modem receiving a Destination Up Response Message containing a Status Data Item with status code of any value other than 0 'Success' MUST NOT send further Destination messages about the destination,

e.g. Destination Down ([Section 10.15](#)) or Destination Update ([Section 10.17](#)) with the same MAC address.

10.13. Destination Announce Message

Usually a modem will discover the presence of one or more remote router/modem pairs and announce each destination's arrival by sending a corresponding Destination Up Message ([Section 10.11](#)) to the router. However, there may be times when a router wishes to express an interest in a destination that has yet to be announced, typically a multicast destination. Destination Announce Messages MAY be sent by a router to announce such an interest.

A Destination Announce Message MAY also be sent by a router to request information concerning a destination in which it has previously declined interest, via the 1 'Not Interested' status code in a Destination Up Response Message ([Section 10.12](#)), see Table 2, or declared as 'down', via the Destination Down Message ([Section 10.15](#)).

To construct a Destination Announce Message, the Message Type value in the Message Header is set to 9 (see Message Type Registration ([Section 13.3](#))).

The Destination Announce Message MUST contain a MAC Address Data Item ([Section 11.7](#)).

The Destination Announce Message MAY contain zero or more of the following Data Items, with different values:

- o IPv4 Address ([Section 11.8](#))
- o IPv6 Address ([Section 11.9](#))

One of the advantages of implementing DLEP is to leverage the modem's knowledge of the links between remote destinations allowing routers to avoid using probed neighbor discovery techniques, therefore modem implementations SHOULD announce available destinations via the Destination Up Message, rather than relying on Destination Announce Messages.

10.14. Destination Announce Response Message

A modem MUST send a Destination Announce Response Message when a Destination Announce Message ([Section 10.13](#)) is received.

To construct a Destination Announce Response Message, the Message Type value in the Message Header is set to 10 (see Message Type Registration ([Section 13.3](#))).

The Destination Announce Response Message MUST contain one of each of the following Data Items:

- o MAC Address ([Section 11.7](#))
- o Status ([Section 11.1](#))

The Destination Announce Response Message MAY contain one or more of each of the following Data Items, with different values:

- o IPv4 Address ([Section 11.8](#))
- o IPv6 Address ([Section 11.9](#))
- o IPv4 Attached Subnet ([Section 11.10](#))
- o IPv6 Attached Subnet ([Section 11.11](#))

The Destination Announce Response Message MAY contain one of each of the following Data Items:

- o Maximum Data Rate (Receive) ([Section 11.12](#))
- o Maximum Data Rate (Transmit) ([Section 11.13](#))
- o Current Data Rate (Receive) ([Section 11.14](#))
- o Current Data Rate (Transmit) ([Section 11.15](#))
- o Latency ([Section 11.16](#))

The Destination Announce Response Message MAY contain one of each of the following Data Items, if the Data Item is in use by the session:

- o Resources ([Section 11.17](#))
- o Relative Link Quality (Receive) ([Section 11.18](#))
- o Relative Link Quality (Transmit) ([Section 11.19](#))
- o Maximum Transmission Unit (MTU) ([Section 11.20](#))

If a modem is unable to report information immediately about the requested information, if the destination is not currently reachable, for example, the status code in the Status Data Item MUST be set to 2 'Request Denied', see Table 2.

After sending a Destination Announce Response Message containing a Status Data Item with status code of 0 'Success', a modem then announces changes to the link to the destination via Destination Update Messages.

When a successful Destination Announce Response Message is received, the router should add knowledge of the available destination to its information base.

10.15. Destination Down Message

A modem MUST send a Destination Down Message to report when a destination (a remote node or a multicast group) is no longer reachable.

A router MAY send a Destination Down Message to report when it no longer requires information concerning a destination.

To construct a Destination Down Message, the Message Type value in the Message Header is set to 11 (see Message Type Registration ([Section 13.3](#))).

The Destination Down Message MUST contain a MAC Address Data Item ([Section 11.7](#)).

It should be noted that both modem and router may send a Destination Down Message to their peer, regardless of which participant initially indicated the destination to be 'up'.

10.16. Destination Down Response Message

A Destination Down Response MUST be sent by the recipient of a Destination Down Message ([Section 10.15](#)) to confirm that the relevant data concerning the destination has been removed from the information base.

To construct a Destination Down Response Message, the Message Type value in the Message Header is set to 12 (see Message Type Registration ([Section 13.3](#))).

The Destination Down Response Message MUST contain one of each of the following Data Items:

- o MAC Address ([Section 11.7](#))
- o Status ([Section 11.1](#))

10.17. Destination Update Message

A modem SHOULD send the Destination Update Message when it detects some change in the information base for a given destination (remote node or multicast group). Some examples of changes that would prompt a Destination Update Message are:

- o Change in link metrics (e.g., Data Rates)
- o Layer 3 addressing change

To construct a Destination Update Message, the Message Type value in the Message Header is set to 13 (see Message Type Registration ([Section 13.3](#))).

The Destination Update Message MUST contain a MAC Address Data Item ([Section 11.7](#)).

The Destination Update Message MAY contain one of each of the following Data Items:

- o Maximum Data Rate (Receive) ([Section 11.12](#))
- o Maximum Data Rate (Transmit) ([Section 11.13](#))
- o Current Data Rate (Receive) ([Section 11.14](#))
- o Current Data Rate (Transmit) ([Section 11.15](#))
- o Latency ([Section 11.16](#))

The Destination Update Message MAY contain one of each of the following Data Items, if the Data Item is in use by the session:

- o Resources ([Section 11.17](#))
- o Relative Link Quality (Receive) ([Section 11.18](#))
- o Relative Link Quality (Transmit) ([Section 11.19](#))
- o Maximum Transmission Unit (MTU) ([Section 11.20](#))

The Destination Update Message MAY contain one or more of each of the following Data Items, with different values:

- o IPv4 Address ([Section 11.8](#))
- o IPv6 Address ([Section 11.9](#))

- o IPv4 Attached Subnet ([Section 11.10](#))
- o IPv6 Attached Subnet ([Section 11.11](#))

If metrics are supplied with the Message (e.g., Resources), these metrics are MUST be applied to all destinations identified in the Message. Note that this may overwrite metrics provided in a previously received Session or Destination Up Messages.

It should be noted that this Message has no corresponding response.

10.18. Link Characteristics Request Message

The Link Characteristics Request Message MAY be sent by a router to request that the modem initiate changes for specific characteristics of the link. The request can reference either a real destination (e.g., a remote node), or a logical destination (e.g., a multicast group) within the network.

To construct a Link Characteristics Request Message, the Message Type value in the Message Header is set to 14 (see Message Type Registration ([Section 13.3](#))).

The Link Characteristics Request Message MUST contain one of the following Data Items:

- o MAC Address ([Section 11.7](#))

The Link Characteristics Request Message MUST contain at least one of each of the following Data Items:

- o Current Data Rate (Receive) ([Section 11.14](#))
- o Current Data Rate (Transmit) ([Section 11.15](#))
- o Latency ([Section 11.16](#))

The Link Characteristics Request Message MAY contain either a Current Data Rate (CDRR or CDRT) Data Item to request a different datarate than is currently allocated, a Latency Data Item to request that traffic delay on the link not exceed the specified value, or both.

The router sending a Link Characteristics Request Message should be aware that a request may take an extended period of time to complete.

10.19. Link Characteristics Response Message

A modem MUST send a Link Characteristics Response Message when a Link Characteristics Request Message ([Section 10.18](#)) is received.

To construct a Link Characteristics Response Message, the Message Type value in the Message Header is set to 15 (see Message Type Registration ([Section 13.3](#))).

The Link Characteristics Response Message MUST contain one of each of the following Data Items:

- o MAC Address ([Section 11.7](#))
- o Status ([Section 11.1](#))

The Link Characteristics Response Message SHOULD contain one of each of the following Data Items:

- o Maximum Data Rate (Receive) ([Section 11.12](#))
- o Maximum Data Rate (Transmit) ([Section 11.13](#))
- o Current Data Rate (Receive) ([Section 11.14](#))
- o Current Data Rate (Transmit) ([Section 11.15](#))
- o Latency ([Section 11.16](#))

The Link Characteristics Response Message MAY contain one of each of the following Data Items, if the Data Item is in use by the session:

- o Resources ([Section 11.17](#))
- o Relative Link Quality (Receive) ([Section 11.18](#))
- o Relative Link Quality (Transmit) ([Section 11.19](#))
- o Maximum Transmission Unit (MTU) ([Section 11.20](#))

The Link Characteristics Response Message MUST contain a complete set of metric Data Items, referencing all metrics declared in the Session Initialization Response Message ([Section 10.6](#)). The values in the metric Data Items in the Link Characteristics Response Message MUST reflect the link characteristics after the request has been processed.

If an implementation is not able to alter the characteristics of the link in the manner requested, then the status code of the Status Data Item MUST be set to 2 'Request Denied', see Table 2.

10.20. Heartbeat Message

A Heartbeat Message MUST be sent by a DLEP participant every N milliseconds, where N is defined in the Heartbeat Interval Data Item ([Section 11.5](#)) of the Session Initialization Message ([Section 10.5](#)) or Session Initialization Response Message ([Section 10.6](#)).

To construct a Heartbeat Message, the Message Type value in the Message Header is set to 16 (see Message Type Registration ([Section 13.3](#))).

There are no valid Data Items for the Heartbeat Message.

The Message is used by DLEP participants to detect when a DLEP session peer (either the modem or the router) is no longer communicating, see [Section 5.3.1](#).

11. DLEP Data Items

Following is the list of core Data Items that MUST be recognized by a DLEP compliant implementation. As mentioned before, not all Data Items need be used during a session, but an implementation MUST correctly process these Data Items when correctly associated with a Signal or Message.

The core DLEP Data Items are:

Type Code	Description
0	Reserved
1	Status (Section 11.1)
2	IPv4 Connection Point (Section 11.2)
3	IPv6 Connection Point (Section 11.3)
4	Peer Type (Section 11.4)
5	Heartbeat Interval (Section 11.5)
6	Extensions Supported (Section 11.6)
7	MAC Address (Section 11.7)
8	IPv4 Address (Section 11.8)
9	IPv6 Address (Section 11.9)
10	IPv4 Attached Subnet (Section 11.10)
11	IPv6 Attached Subnet (Section 11.11)
12	Maximum Data Rate (Receive) (MDRR) (Section 11.12)
13	Maximum Data Rate (Transmit) (MDRT) (Section 11.13)
14	Current Data Rate (Receive) (CDRR) (Section 11.14)
15	Current Data Rate (Transmit) (CDRT) (Section 11.15)
16	Latency (Section 11.16)
17	Resources (RES) (Section 11.17)
18	Relative Link Quality (Receive) (RLQR) (Section 11.18)
19	Relative Link Quality (Transmit) (RLQT) (Section 11.19)
20	Maximum Transmission Unit (MTU) (Section 11.20)
21-65407	Reserved for future extensions
65408-65534	Private Use. Available for experiments
65535	Reserved

Table 1: DLEP Data Item types

11.1. Status

For the Session Termination Message ([Section 10.9](#)), the Status Data Item indicates a reason for the termination. For all response Messages, the Status Data Item is used to indicate the success or failure of the previously received Message.

The Status Data Item includes an optional Text field that can be used to provide a textual description of the status. The use of the Text field is entirely up to the receiving implementation, e.g., it could be output to a log file or discarded. If no Text field is supplied with the Status Data Item, the Length field MUST be set to 1.

The Status Data Item contains the following fields:

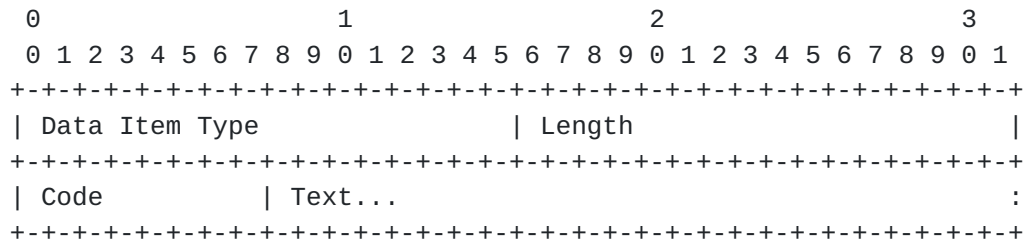

Data Item Type: 1

Length: 1 + Length of text, in octets

Status Code: One of the codes defined in Table 2 below.

Text: UTF-8 encoded string of UNICODE [UNIV8] characters, describing the cause, used for implementation defined purposes. Since this field is used for description, implementations SHOULD limit characters in this field to printable characters. Implementations receiving this Data Item SHOULD check for printable characters in the field.

An implementation MUST NOT assume the Text field is NUL-terminated.

Status Code	Failure Mode	Description	Reason
0	Continue	Success	The Message was processed successfully.
1	Continue	Not Interested	The receiver is not interested in this Message subject, e.g. in a Destination Up Response Message (Section 10.12) to indicate no further Messages about the destination.
2	Continue	Request Denied	The receiver refuses to complete the request.
3-111	Continue	<Reserved>	Reserved for future extensions.
112-127	Continue	<Private Use>	Available for experiments.
128	Terminate	Unknown Message	The Message was not recognized by the

			implementation.
129	Terminate	Unexpected Message	The Message was not expected while the device was in the current state, e.g., a Session Initialization Message (Section 10.5) in the In-Session state.
130	Terminate	Invalid Data	One or more Data Items in the Message are invalid, unexpected or incorrectly duplicated.
131	Terminate	Invalid Destination	The destination included in the Message does not match a previously announced destination. For example, in the Link Characteristic Response Message (Section 10.19).
132	Terminate	Timed Out	The session has timed out.
133-239	Terminate	<Reserved>	Reserved for future extensions.
240-254	Terminate	<Private Use>	Available for experiments.
255	Terminate	<Reserved>	Reserved.

Table 2: DLEP Status Codes

[11.2.](#) IPv4 Connection Point

The IPv4 Connection Point Data Item indicates the IPv4 address and, optionally, the TCP port number on the modem available for connections. If provided, the router MUST use this information to initiate the TCP connection to the modem.

The IPv4 Connection Point Data Item contains the following fields:

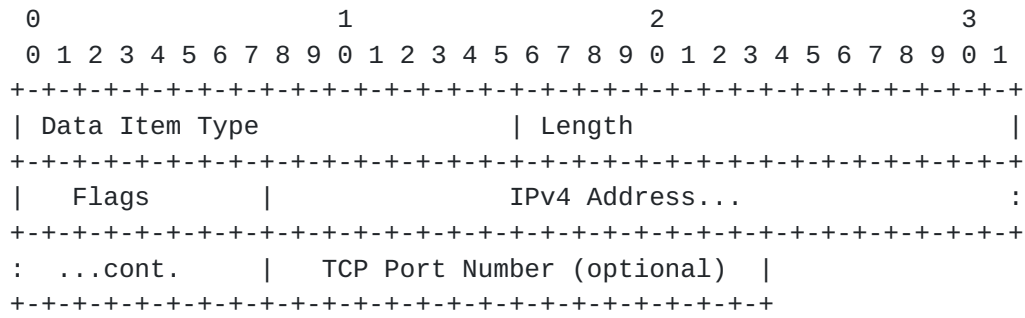

Data Item Type: 2

Length: 5 (or 7 if TCP Port included)

Flags: Flags field, defined below.

IPv4 Address: The IPv4 address listening on the modem.

TCP Port Number: TCP Port number on the modem.

If the Length field is 7, the port number specified MUST be used to establish the TCP session. If the TCP Port Number is omitted, i.e. the Length field is 5, the router MUST use the DLEP well-known port number ([Section 13.7](#)) to establish the TCP connection.

The Flags field is defined as:

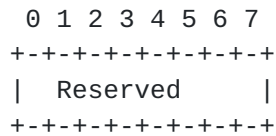

Reserved: MUST be zero. Reserved for future use.

11.3. IPv6 Connection Point

The IPv6 Connection Point Data Item indicates the IPv6 address and, optionally, the TCP port number on the modem available for connections. If provided, the router MUST use this information to initiate the TCP connection to the modem.

The IPv6 Connection Point Data Item contains the following fields:

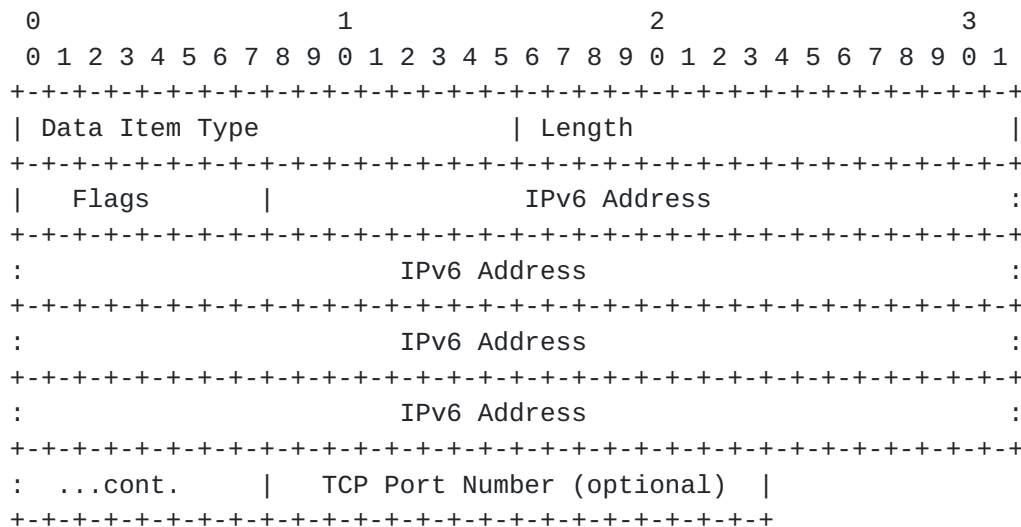

Data Item Type: 3

Length: 17 (or 19 if TCP Port included)

Flags: Flags field, defined below.

IPv6 Address: The IPv6 address listening on the modem.

TCP Port Number: TCP Port number on the modem.

If the Length field is 19, the port number specified MUST be used to establish the TCP session. If the TCP Port Number is omitted, i.e. the Length field is 17, the router MUST use the DLEP well-known port number ([Section 13.7](#)) to establish the TCP connection.

The Flags field is defined as:

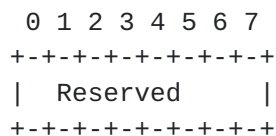

Reserved: MUST be zero. Reserved for future use.

11.4. Peer Type

The Peer Type Data Item is used by the router and modem to give additional information as to its type. The Peer Type is a string and is envisioned to be used for informational purposes (e.g., as output in a display command).

The Peer Type Data Item contains the following fields:

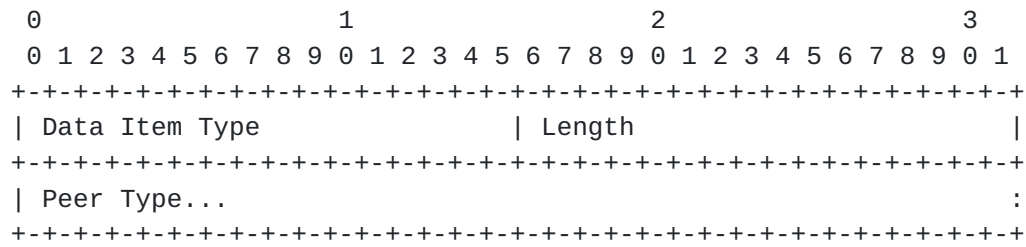

Data Item Type: 4

Length: Length of Peer Type string, in octets.

Peer Type: UTF-8 encoded string of UNICODE [UNIV8] characters. For example, a satellite modem might set this variable to "Satellite terminal". Since this Data Item is intended to provide additional information for display commands, sending implementations SHOULD limit the data to printable characters, and receiving implementations SHOULD check the data for printable characters.

An implementation MUST NOT assume the Peer Type field is NUL-terminated.

11.5. Heartbeat Interval

The Heartbeat Interval Data Item is used to specify a period in milliseconds for Heartbeat Messages (Section 10.20).

The Heartbeat Interval Data Item contains the following fields:

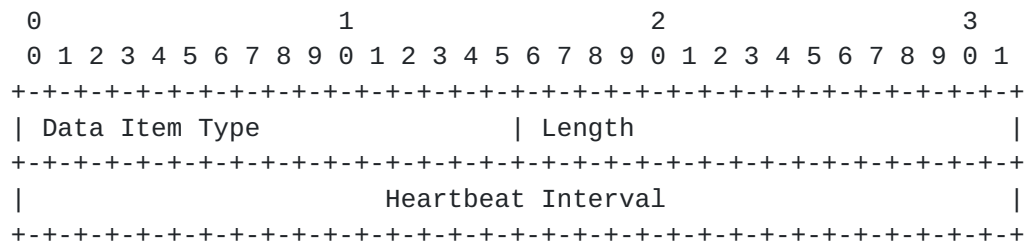

Data Item Type: 5

Length: 4

Heartbeat Interval: The interval in milliseconds, expressed as a 32-bit unsigned integer, for Heartbeat Messages. This value MUST NOT be 0.

11.6. Extensions Supported

The Extensions Supported Data Item is used by the router and modem to negotiate additional optional functionality they are willing to support. The Extensions List is a concatenation of the types of each supported extension, found in the IANA DLEP Extensions repository. Each Extension Type definition includes which additional Signals and Data Items are supported.

The Extensions Supported Data Item contains the following fields:

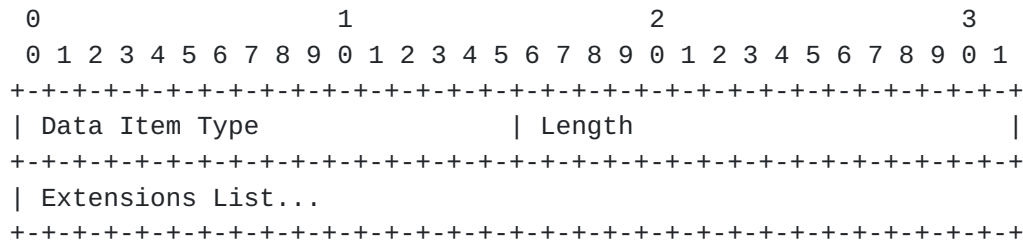

Data Item Type: 6

Length: Length of the extensions list in octets. This is twice (2x) the number of extensions.

Extension List: A list of extensions supported, identified by their 2-octet value as listed in the extensions registry.

11.7. MAC Address

The MAC Address Data Item contains the address of the destination on the remote node.

DLEP can support MAC addresses in either EUI-48 or EUI-64 format, with the restriction that all MAC addresses for a given DLEP session MUST be in the same format, and MUST be consistent with the MAC address format of the connected modem (e.g., if the modem is connected to the router with an EUI-48 MAC, all destination addresses via that modem MUST be expressed in EUI-48 format).

Examples of a virtual destination would be a multicast MAC address, or the broadcast MAC (FF:FF:FF:FF:FF:FF).

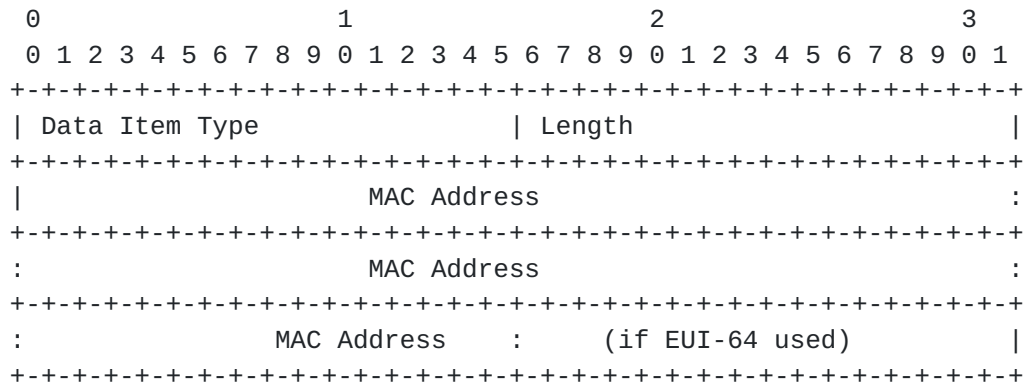

Data Item Type: 7

Length: 6 for EUI-48 format, or 8 for EUI-64 format

MAC Address: MAC Address of the destination.

11.8. IPv4 Address

When included in Destination Messages, this Data Item contains the IPv4 address of the destination. When included in the Session Update Message, this Data Item contains the IPv4 address of the peer. In either case, the Data Item also contains an indication of whether this is a new or existing address, or is a deletion of a previously known address.

The IPv4 Address Data Item contains the following fields:

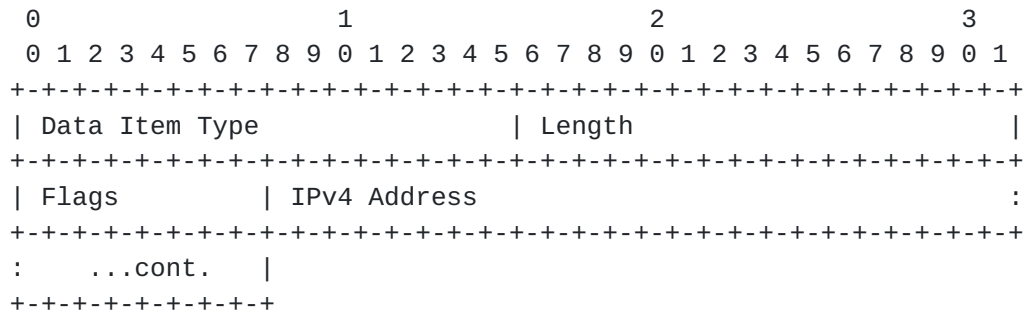

Data Item Type: 8

Length: 5

Flags: Flags field, defined below.

IPv4 Address: The IPv4 address of the destination or peer.

The Flags field is defined as:

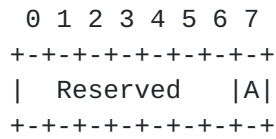

A: Add/Drop flag, indicating whether this is a new or existing address (1), or a withdrawal of an address (0).

Reserved: MUST be zero. Reserved for future use.

11.9. IPv6 Address

When included in Destination Messages, this Data Item contains the IPv6 address of the destination. When included in the Session Update Message, this Data Item contains the IPv6 address of the peer. In either case, the Data Item also contains an indication of whether this is a new or existing address, or is a deletion of a previously known address.

The IPv6 Address Data Item contains the following fields:

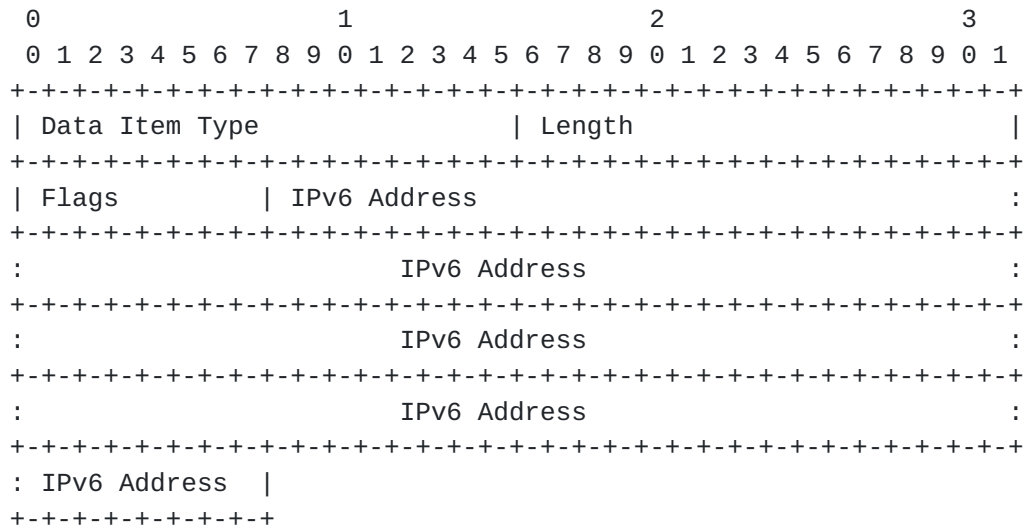

Data Item Type: 9

Length: 17

Flags: Flags field, defined below.

IPv6 Address: IPv6 Address of the destination or peer.

The Flags field is defined as:

```

 0 1 2 3 4 5 6 7
+---+---+---+---+
| Reserved  |A|
+---+---+---+---+

```

A: Add/Drop flag, indicating whether this is a new or existing address (1), or a withdrawal of an address (0).

Reserved: MUST be zero. Reserved for future use.

11.10. IPv4 Attached Subnet

The DLEP IPv4 Attached Subnet allows a device to declare that it has an IPv4 subnet (e.g., a stub network) attached, that it has become aware of an IPv4 subnet being present at a remote destination, or that it has become aware of the loss of a subnet at the remote destination.

The DLEP IPv4 Attached Subnet Data Item contains the following fields:

```

 0                               1                               2                               3
 0 1 2 3 4 5 6 7 8 9 0 1 2 3 4 5 6 7 8 9 0 1 2 3 4 5 6 7 8 9 0 1
+---+---+---+---+---+---+---+---+---+---+---+---+---+---+---+---+
| Data Item Type                               | Length                               |
+---+---+---+---+---+---+---+---+---+---+---+---+---+---+---+---+
| Flags                                         | IPv4 Attached Subnet                               :
+---+---+---+---+---+---+---+---+---+---+---+---+---+---+---+---+
:   ...cont. |Prefix Length |
+---+---+---+---+---+---+---+---+---+---+

```

Data Item Type: 10

Length: 6

Flags: Flags field, defined below.

IPv4 Subnet: The IPv4 subnet reachable at the destination.

Prefix Length: Length of the prefix (0-32) for the IPv4 subnet. A prefix length outside the specified range MUST be considered as invalid.

The Flags field is defined as:

```

 0 1 2 3 4 5 6 7
+---+---+---+---+
| Reserved  |A|
+---+---+---+---+

```

A: Add/Drop flag, indicating whether this is a new or existing subnet address (1), or a withdrawal of a subnet address (0).

Reserved: MUST be zero. Reserved for future use.

11.11. IPv6 Attached Subnet

The DLEP IPv6 Attached Subnet allows a device to declare that it has an IPv6 subnet (e.g., a stub network) attached, that it has become aware of an IPv6 subnet being present at a remote destination, or that it has become aware of the loss of a subnet at the remote destination.

The DLEP IPv6 Attached Subnet Data Item contains the following fields:

```

 0                               1                               2                               3
 0 1 2 3 4 5 6 7 8 9 0 1 2 3 4 5 6 7 8 9 0 1 2 3 4 5 6 7 8 9 0 1
+---+---+---+---+---+---+---+---+---+---+---+---+---+---+---+---+
| Data Item Type                               | Length                               |
+---+---+---+---+---+---+---+---+---+---+---+---+---+---+---+---+
|  Flags                               | IPv6 Attached Subnet                               :
+---+---+---+---+---+---+---+---+---+---+---+---+---+---+---+---+
:                               IPv6 Attached Subnet                               :
+---+---+---+---+---+---+---+---+---+---+---+---+---+---+---+---+
:                               IPv6 Attached Subnet                               :
+---+---+---+---+---+---+---+---+---+---+---+---+---+---+---+---+
:                               IPv6 Attached Subnet                               :
+---+---+---+---+---+---+---+---+---+---+---+---+---+---+---+---+
:  ...cont.  | Prefix Len.  |
+---+---+---+---+---+---+---+---+---+---+---+---+---+---+---+---+

```

Data Item Type: 11

Length: 18

Flags: Flags field, defined below.

IPv6 Attached Subnet: The IPv6 subnet reachable at the destination.

Prefix Length: Length of the prefix (0-128) for the IPv6 subnet. A prefix length outside the specified range MUST be considered as invalid.

The Flags field is defined as:

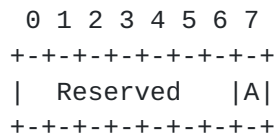

A: Add/Drop flag, indicating whether this is a new or existing subnet address (1), or a withdrawal of a subnet address (0).

Reserved: MUST be zero. Reserved for future use.

11.12. Maximum Data Rate (Receive)

The Maximum Data Rate (Receive) (MDRR) Data Item is used to indicate the maximum theoretical data rate, in bits per second, that can be achieved while receiving data on the link.

The Maximum Data Rate (Receive) Data Item contains the following fields:



Data Item Type: 12

Length: 8

Maximum Data Rate (Receive): A 64-bit unsigned integer, representing the maximum theoretical data rate, in bits per second (bps), that can be achieved while receiving on the link.

11.13. Maximum Data Rate (Transmit)

The Maximum Data Rate (Transmit) (MDRT) Data Item is used to indicate the maximum theoretical data rate, in bits per second, that can be achieved while transmitting data on the link.

The Maximum Data Rate (Transmit) Data Item contains the following fields:

0										1										2										3									
0	1	2	3	4	5	6	7	8	9	0	1	2	3	4	5	6	7	8	9	0	1	2	3	4	5	6	7	8	9	0	1	2	3	4	5	6	7	8	9
Data Item Type										Length																													
MDRT (bps)																														:									
:										MDRT (bps)																													

Data Item Type: 13

Length: 8

Maximum Data Rate (Transmit): A 64-bit unsigned integer, representing the maximum theoretical data rate, in bits per second (bps), that can be achieved while transmitting on the link.

11.14. Current Data Rate (Receive)

The Current Data Rate (Receive) (CDRR) Data Item is used to indicate the rate at which the link is currently operating for receiving traffic.

When used in the Link Characteristics Request Message ([Section 10.18](#)), Current Data Rate (Receive) represents the desired receive rate, in bits per second, on the link.

The Current Data Rate (Receive) Data Item contains the following fields:

0										1										2										3									
0	1	2	3	4	5	6	7	8	9	0	1	2	3	4	5	6	7	8	9	0	1	2	3	4	5	6	7	8	9	0	1	2	3	4	5	6	7	8	9
Data Item Type										Length																													
CDRR (bps)																														:									
:										CDRR (bps)																													

Data Item Type: 14

Length: 8

Current Data Rate (Receive): A 64-bit unsigned integer, representing the current data rate, in bits per second, that can currently be achieved while receiving traffic on the link.

If there is no distinction between Current Data Rate (Receive) and Maximum Data Rate (Receive) ([Section 11.12](#)), Current Data Rate (Receive) MUST be set equal to the Maximum Data Rate (Receive). The Current Data Rate (Receive) MUST NOT exceed the Maximum Data Rate (Receive).

11.15. Current Data Rate (Transmit)

The Current Data Rate (Transmit) (CDRT) Data Item is used to indicate the rate at which the link is currently operating for transmitting traffic.

When used in the Link Characteristics Request Message ([Section 10.18](#)), Current Data Rate (Transmit) represents the desired transmit rate, in bits per second, on the link.

The Current Data Rate (Transmit) Data Item contains the following fields:

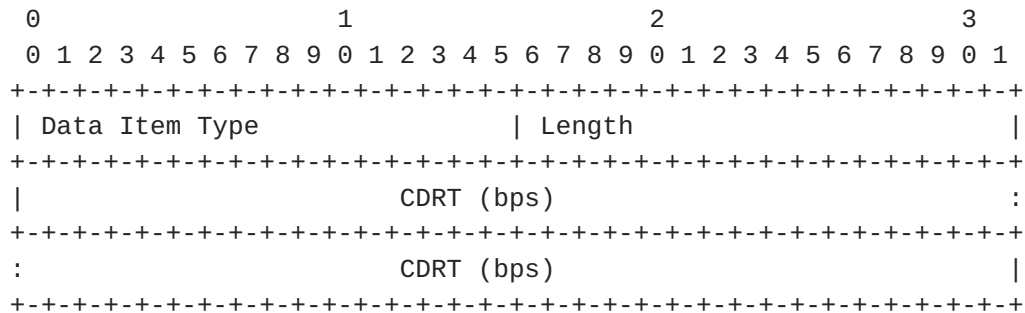

Data Item Type: 15

Length: 8

Current Data Rate (Transmit): A 64-bit unsigned integer, representing the current data rate, in bits per second, that can currently be achieved while transmitting traffic on the link.

If there is no distinction between Current Data Rate (Transmit) and Maximum Data Rate (Transmit) ([Section 11.13](#)), Current Data Rate (Transmit) MUST be set equal to the Maximum Data Rate (Transmit). The Current Data Rate (Transmit) MUST NOT exceed the Maximum Data Rate (Transmit).

11.16. Latency

The Latency Data Item is used to indicate the amount of latency, in microseconds, on the link.

The Latency value is reported as transmission delay. The calculation of latency is implementation dependent. For example, the latency may be a running average calculated from the internal queuing.

The Latency Data Item contains the following fields:

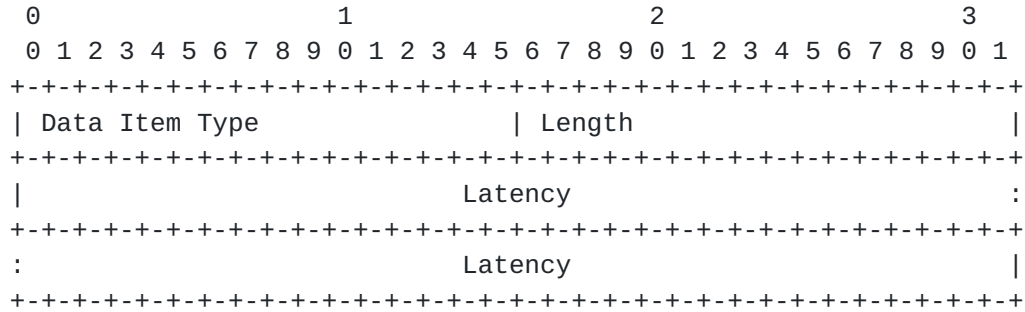

Data Item Type: 16

Length: 8

Latency: A 64-bit unsigned integer, representing the transmission delay, in microseconds, that a packet encounters as it is transmitted over the link.

11.17. Resources

The Resources (RES) Data Item is used to indicate the amount of finite resources available for data transmission and reception at the destination as a percentage, with 0 meaning 'no resources remaining', and 100 meaning 'a full supply', assuming that when Resources reaches 0 data transmission and/or reception will cease.

An example of such resources might be battery life, but could equally be magic beans. The list of resources that might be considered is beyond the scope of this document, and is left to implementations to decide.

This Data Item is designed to be used as an indication of some capability of the modem and/or router at the destination.

The Resources Data Item contains the following fields:

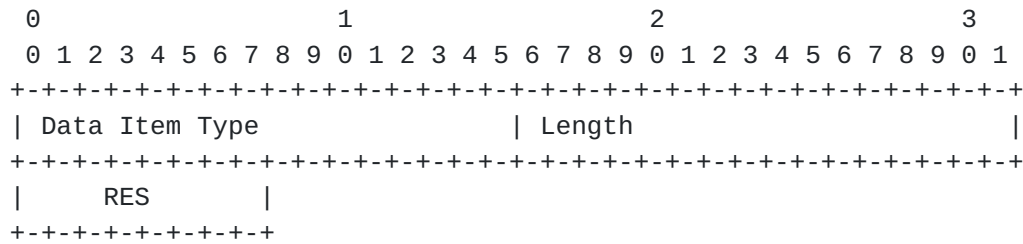

Data Item Type: 17

Length: 1

Resources: An 8-bit unsigned integer percentage, 0-100, representing the amount of resources available. Any value greater than 100 MUST be considered as invalid.

If a device cannot calculate Resources, this Data Item MUST NOT be issued.

11.18. Relative Link Quality (Receive)

The Relative Link Quality (Receive) (RLQR) Data Item is used to indicate the quality of the link to a destination for receiving traffic, with 0 meaning 'worst quality', and 100 meaning 'best quality'.

Quality in this context is defined as an indication of the stability of a link for reception; a destination with high Relative Link Quality (Receive) is expected to have generally stable DLEP metrics, and the metrics of a destination with low Relative Link Quality (Receive) can be expected to rapidly fluctuate over a wide range.

The Relative Link Quality (Receive) Data Item contains the following fields:

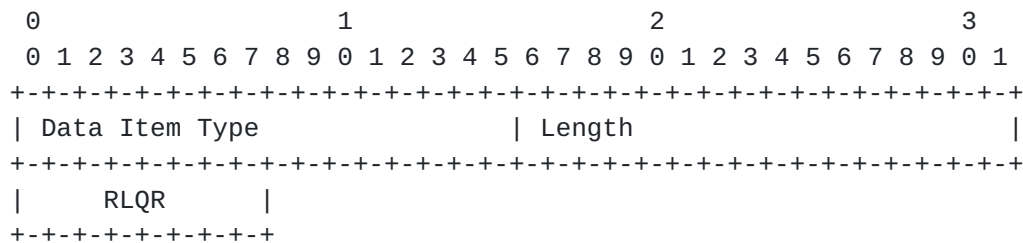

Data Item Type: 18

Length: 1

Relative Link Quality (Receive): A non-dimensional unsigned 8-bit integer, 0-100, representing relative quality of the link for receiving traffic. Any value greater than 100 MUST be considered as invalid.

If a device cannot calculate the Relative Link Quality (Receive), this Data Item MUST NOT be issued.

11.19. Relative Link Quality (Transmit)

The Relative Link Quality (Transmit) (RLQT) Data Item is used to indicate the quality of the link to a destination for transmitting traffic, with 0 meaning 'worst quality', and 100 meaning 'best quality'.

Quality in this context is defined as an indication of the stability of a link for transmission; a destination with high Relative Link Quality (Transmit) is expected to have generally stable DLEP metrics, and the metrics of a destination with low Relative Link Quality (Transmit) can be expected to rapidly fluctuate over a wide range.

The Relative Link Quality (Transmit) Data Item contains the following fields:

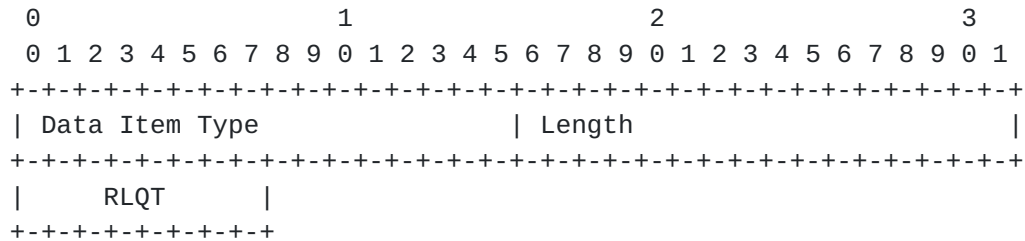

Data Item Type: 19

Length: 1

Relative Link Quality (Transmit): A non-dimensional unsigned 8-bit integer, 0-100, representing relative quality of the link for transmitting traffic. Any value greater than 100 MUST be considered as invalid.

If a device cannot calculate the Relative Link Quality (Transmit), this Data Item MUST NOT be issued.

11.20. Maximum Transmission Unit (MTU)

The Maximum Transmission Unit (MTU) Data Item is used to indicate the maximum size, in octets, of an IP packet that can be transmitted without fragmentation, including headers, but excluding any lower layer headers.

The Maximum Transmission Unit Data Item contains the following fields:

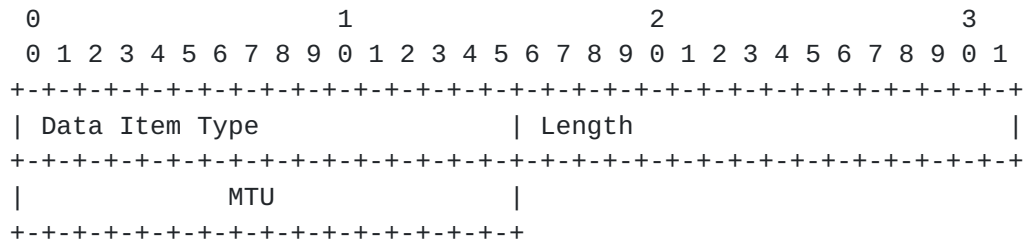

Data Item Type: 20

Length: 2

Maximum Transmission Unit: The maximum size, in octets, of an IP packet that can be transmitted without fragmentation, including headers, but excluding any lower layer headers.

If a device cannot calculate the Maximum Transmission Unit, this Data Item MUST NOT be issued.

12. Security Considerations

The potential security concerns when using DLEP are:

1. An attacker might pretend to be a DLEP participant, either at DLEP session initialization, or by injection of DLEP Messages once a session has been established, and/or
2. DLEP Data Items could be altered by an attacker, causing the receiving implementation to inappropriately alter its information base concerning network status.

Since DLEP is restricted to operation over a single (possibly logical) hop at layer 2, implementations requiring authentication and/or encryption of traffic MUST take steps to secure the Layer 2 link. Examples of technologies that can be deployed to secure the Layer 2 link include [[IEEE-802.1AE](#)] and [[IEEE-802.1X](#)].

To avoid potential denial of service attack, it is RECOMMENDED that implementations using the Peer Discovery mechanism maintain an information base of hosts that persistently fail Session Initialization having provided an acceptable Peer Discovery Signal, and ignore subsequent Peer Discovery Signals from such hosts.

This specification does not address security of the data plane, as it (the data plane) is not affected, and standard security procedures can be employed.

13. IANA Considerations

This section specifies requests to IANA.

13.1. Registrations

Upon approval of this document, IANA is requested to create a new protocol registry for Dynamic Link Exchange Protocol (DLEP). The remainder of this section requests the creation of new DLEP specific registries.

13.2. Signal Type Registration

Upon approval of this document, IANA is requested to create a new DLEP registry, named "Signal Type Values".

The following table provides initial registry values and the [RFC5226] defined policies that should apply to the registry:

Type Code	Description/Policy
0	Reserved
1	Peer Discovery Signal
2	Peer Offer Signal
3-65519	Specification Required
65520-65534	Private Use
65535	Reserved

13.3. Message Type Registration

Upon approval of this document, IANA is requested to create a new DLEP registry, named "Message Type Values".

The following table provides initial registry values and the [RFC5226] defined policies that should apply to the registry:

Type Code	Description/Policy
0	Reserved
1	Session Initialization Message
2	Session Initialization Response Message
3	Session Update Message
4	Session Update Response Message
5	Session Termination Message
6	Session Termination Response Message
7	Destination Up Message
8	Destination Up Response Message
9	Destination Announce Message
10	Destination Announce Response Message
11	Destination Down Message
12	Destination Down Response Message
13	Destination Update Message
14	Link Characteristics Request Message
15	Link Characteristics Response Message
16	Heartbeat Message
17-65519	Specification Required
65520-65534	Private Use
65535	Reserved

13.4. DLEP Data Item Registrations

Upon approval of this document, IANA is requested to create a new DLEP registry, named "Data Item Values".

The following table provides initial registry values and the [\[RFC5226\]](#) defined policies that should apply to the registry:

Type Code	Description/Policy
0	Reserved
1	Status
2	IPv4 Connection Point
3	IPv6 Connection Point
4	Peer Type
5	Heartbeat Interval
6	Extensions Supported
7	MAC Address
8	IPv4 Address
9	IPv6 Address
10	IPv4 Attached Subnet
11	IPv6 Attached Subnet
12	Maximum Data Rate (Receive) (MDRR)
13	Maximum Data Rate (Transmit) (MDRT)
14	Current Data Rate (Receive) (CDRR)
15	Current Data Rate (Transmit) (CDRT)
16	Latency
17	Resources (RES)
18	Relative Link Quality (Receive) (RLQR)
19	Relative Link Quality (Transmit) (RLQT)
20	Maximum Transmission Unit (MTU)
21-65407	Specification Required
65408-65534	Private Use
65535	Reserved

13.5. DLEP Status Code Registrations

Upon approval of this document, IANA is requested to create a new DLEP registry, named "Status Code Values".

The following table provides initial registry values and the [\[RFC5226\]](#) defined policies that should apply to the registry:

Status Code	Failure Mode	Description/Policy
0	Continue	Success
1	Continue	Not Interested
2	Continue	Request Denied
3-111	Continue	Specification Required
112-127	Continue	Private Use
128	Terminate	Unknown Message
129	Terminate	Unexpected Message
130	Terminate	Invalid Data
131	Terminate	Invalid Destination
132	Terminate	Timed Out
133-239	Terminate	Specification Required
240-254	Terminate	Private Use
255	Terminate	Reserved

13.6. DLEP Extensions Registrations

Upon approval of this document, IANA is requested to create a new DLEP registry, named "Extension Type Values".

The following table provides initial registry values and the [RFC5226] defined policies that should apply to the registry:

Code	Description/Policy
0	Reserved
1	Credit Windowing [CREDIT]
2-65519	Specification Required
65520-65534	Private Use
65535	Reserved

Table 3: DLEP Extension types

13.7. DLEP Well-known Port

Upon approval of this document, IANA is requested to assign a single value in the "Service Name and Transport Protocol Port Number Registry" found at <https://www.iana.org/assignments/service-names-port-numbers/service-names-port-numbers.xhtml> for use by "DLEP", as defined in this document. This assignment should be valid for TCP and UDP.

13.8. DLEP IPv4 Link-local Multicast Address

Upon approval of this document, IANA is requested to assign an IPv4 multicast address registry found at <http://www.iana.org/assignments/multicast-addresses> for use as the "IPv4 DLEP Discovery Address".

13.9. DLEP IPv6 Link-local Multicast Address

Upon approval of this document, IANA is requested to assign an IPv6 multicast address registry found at <http://www.iana.org/assignments/multicast-addresses> for use as the "IPv6 DLEP Discovery Address".

14. Acknowledgements

We would like to acknowledge and thank the members of the DLEP design team, who have provided invaluable insight. The members of the design team are: Teco Boot, Bow-Nan Cheng, John Dowdell, and Henning Rogge.

We would also like to acknowledge the influence and contributions of Greg Harrison, Chris Olsen, Martin Duke, Subir Das, Jaewon Kang, Vikram Kaul, Nelson Powell, Lou Berger, and Victoria Pritchard.

15. References

15.1. Normative References

- [RFC2119] Bradner, S., "Key words for use in RFCs to Indicate Requirement Levels", [BCP 14](#), [RFC 2119](#), DOI 10.17487/RFC2119, March 1997, <<http://www.rfc-editor.org/info/rfc2119>>.
- [RFC5082] Gill, V., Heasley, J., Meyer, D., Savola, P., Ed., and C. Pignataro, "The Generalized TTL Security Mechanism (GTSM)", [RFC 5082](#), DOI 10.17487/RFC5082, October 2007, <<http://www.rfc-editor.org/info/rfc5082>>.
- [UNIV8] "The Unicode Consortium. The Unicode Standard, Version 8.0.0, (Mountain View, CA: The Unicode Consortium, 2015. ISBN 978-1-936213-10-8)", <http://www.unicode.org/versions/Unicode8.0.0/>, June 2015.

15.2. Informative References

- [CREDIT] Ratliff, S., "Credit Windowing extension for DLEP", IETF draft [draft-ietf-manet-credit-window-04](#), March 2016.

[IEEE-802.1AE]

"IEEE Standards for Local and Metropolitan Area Networks: Media Access Control (MAC) Security", DOI 10.1109/IEEESTD.2006.245590, August 2006.

[IEEE-802.1X]

"IEEE Standards for Local and Metropolitan Area Networks: Port based Network Access Control", DOI 10.1109/IEEESTD.2010.5409813, February 2010.

[RFC5226]

Narten, T. and H. Alvestrand, "Guidelines for Writing an IANA Considerations Section in RFCs", BCP 26, RFC 5226, DOI 10.17487/RFC5226, May 2008, <http://www.rfc-editor.org/info/rfc5226>.

[RFC5578]

Berry, B., Ed., Ratliff, S., Paradise, E., Kaiser, T., and M. Adams, "PPP over Ethernet (PPPoE) Extensions for Credit Flow and Link Metrics", RFC 5578, DOI 10.17487/RFC5578, February 2010, <http://www.rfc-editor.org/info/rfc5578>.

Appendix A. Discovery Signal Flows

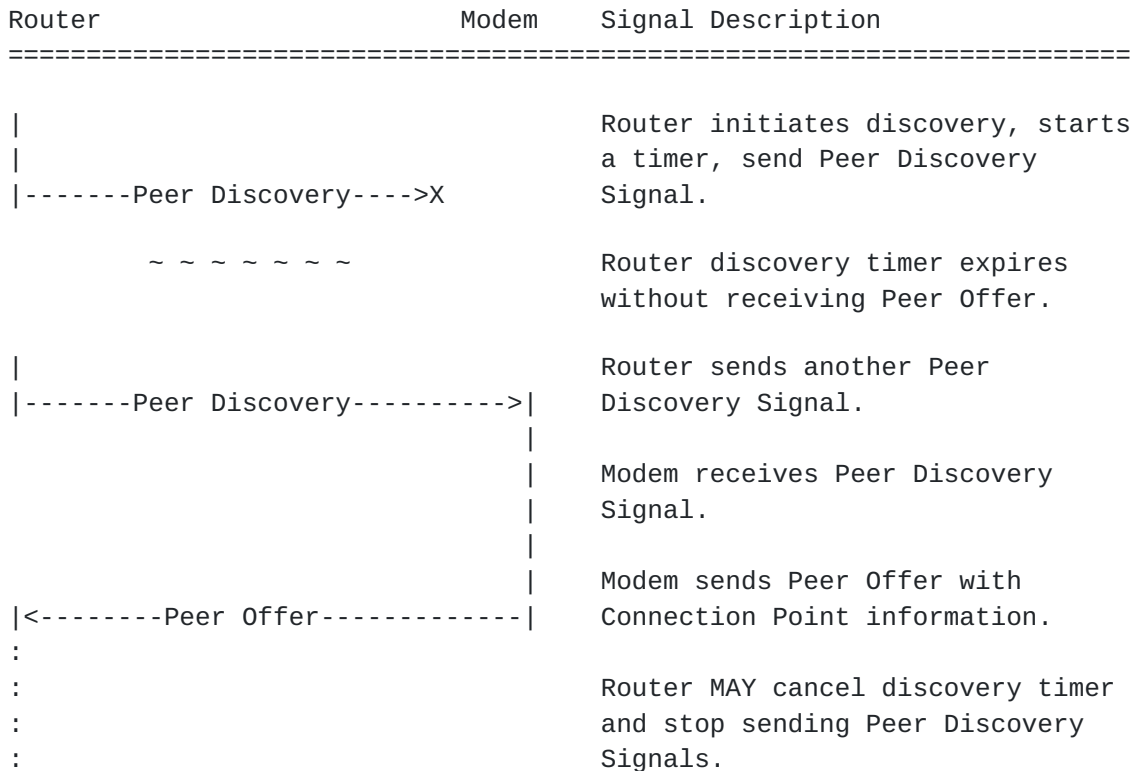

Appendix B. Peer Level Message Flows

B.1. Session Initialization

Router	Modem	Message Description
		Router connects to discovered or pre-configured Modem Connection Point.
--TCP connection established-->		
		Router sends Session Initialization Message.
----Session Initialization----->		
		Modem receives Session Initialization Message.
		Modem sends Session Initialization Response, with Success Status Data Item.
<--Session Initialization Resp.-		
<<=====>>		Session established. Heartbeats begin.
:	:	

B.2. Session Initialization - Refused

Router	Modem	Message Description
		Router connects to discovered or pre-configured Modem Connection Point.
--TCP connection established-->		
		Router sends Session Initialization Message.
-----Session Initialization---->		
		Modem receives Session Initialization Message, and will not support the advertised extensions.
		Modem sends Session Initialization Response, with 'Request Denied' Status Data Item.
<--Session Initialization Resp.--		
		Router receives negative Session Initialization Response, closes TCP connection.
-----TCP close-----		

B.3. Router Changes IP Addresses

Router	Modem	Message Description
		Router sends Session Update Message to announce change of IP address
-----Session Update----->		
		Modem receives Session Update Message and updates internal state.
<----Session Update Response----		Modem sends Session Update Response.

B.4. Modem Changes Session-wide Metrics

Router	Modem	Message Description
<-----Session Update-----		Modem sends Session Update Message to announce change of modem-wide metrics
		Router receives Session Update Message and updates internal state.
----Session Update Response---->		Router sends Session Update Response.

B.5. Router Terminates Session

Router	Modem	Message Description
		Router sends Session Termination Message with Status Data Item.
-----Session Termination----->		Router stops sending Messages.
		Modem receives Session Termination, stops counting received heartbeats and stops sending heartbeats.
		Modem sends Session Termination Response with Status 'Success'.
<---Session Termination Resp.---		Modem stops sending Messages.
		Session terminated.
-----TCP close-----		

B.6. Modem Terminates Session

Router	Modem	Message Description
<----Session Termination-----		Modem sends Session Termination Message with Status Data Item.
		Modem stops sending Messages.
		Router receives Session Termination, stops counting received heartbeats and stops sending heartbeats.
		Router sends Session Termination Response with Status 'Success'.
---Session Termination Resp.--->		Router stops sending Messages.
-----TCP close-----		Session terminated.

B.7. Session Heartbeats

Router	Modem	Message Description
-----Heartbeat----->		Router sends heartbeat Message
		Modem resets heartbeats missed counter.
~ ~ ~ ~ ~		
-----[Any Message]----->		When the Modem receives any Message from the Router.
		Modem resets heartbeats missed counter.
~ ~ ~ ~ ~		
<-----Heartbeat-----		Modem sends heartbeat Message
		Router resets heartbeats missed counter.
~ ~ ~ ~ ~		
<-----[Any Message]-----		When the Router receives any Message from the Modem.
		Modem resets heartbeats missed counter.

B.8. Router Detects a Heartbeat timeout

Router	Modem	Message Description
X<-----		Router misses a heartbeat
		Router misses too many heartbeats
		Router sends Session Termination Message with 'Timeout' Status Data Item.
		Termination proceeds...

B.9. Modem Detects a Heartbeat timeout

Router	Modem	Message Description
----->X		Modem misses a heartbeat
----->X		Modem misses too many heartbeats
<-----Session Termination-----		Modem sends Session Termination
		Message with 'Timeout' Status
		Data Item.
	:	
	:	Termination proceeds...

Appendix C. Destination Specific Message Flows

C.1. Common Destination Notification

Router	Modem	Message Description
=====		
		Modem detects a new logical destination is reachable, and sends Destination Up Message.
<-----Destination Up----->		
-----Destination Up Resp.---->		Router sends Destination Up Response.
		Modem detects change in logical destination metrics, and sends Destination Update Message.
<-----Destination Update----->		
		Modem detects change in logical destination metrics, and sends Destination Update Message.
<-----Destination Update----->		
		Modem detects logical destination is no longer reachable, and sends Destination Down Message.
<-----Destination Down----->		
		Router receives Destination Down, updates internal state, and sends Destination Down Response Message.
-----Destination Down Resp.---->		

C.2. Multicast Destination Notification

Router	Modem	Message Description
=====		
		Router detects a new multicast destination is in use, and sends
		Destination Announce Message.
-----Destination Announce----->		
		Modem updates internal state to monitor multicast destination, and
		sends Destination Announce Response.
<-----Dest. Announce Resp.-----		
		~ ~ ~ ~ ~ ~ ~
		Modem detects change in multicast destination metrics, and sends
		Destination Update Message.
<-----Destination Update-----		
		~ ~ ~ ~ ~ ~ ~
		Modem detects change in multicast destination metrics, and sends
		Destination Update Message.
<-----Destination Update-----		
		~ ~ ~ ~ ~ ~ ~
		Router detects multicast destination is no longer in use, and sends
		Destination Down Message.
-----Destination Down----->		
		Modem receives Destination Down, updates internal state, and sends
		Destination Down Response Message.
<-----Destination Down Resp.-----		

C.3. Link Characteristics Request

Router	Modem	Message Description
=====		

```

~ ~ ~ ~ ~

```

```

Destination has already been
announced by either peer.

```

```

|
|
|
|--Link Characteristics Request-->|

```

```

Router requires different
Characteristics for the
destination, and sends Link
Characteristics Request Message.

```

```

|
|
|<---Link Characteristics Resp.---|

```

```

Modem attempts to adjust link
properties to meet the received
request, and sends a Link
Characteristics Response
Message with the new values.

```

Authors' Addresses

```

Stan Ratliff
VT iDirect
13861 Sunrise Valley Drive, Suite 300
Herndon, VA 20171
USA

```

Email: sratliff@idirect.net

```

Shawn Jury
Cisco Systems
170 West Tasman Drive
San Jose, CA 95134
USA

```

Email: sjury@cisco.com

```

Darryl Satterwhite
Broadcom

```

Email: dsatterw@broadcom.com

Rick Taylor
Airbus Defence & Space
Quadrant House
Celtic Springs
Coedkernew
Newport NP10 8FZ
UK

Email: rick.taylor@airbus.com

Bo Berry