

Network Working Group  
Internet Draft  
Expiration Date: July 2007

R. Aggarwal (Editor)  
Juniper Networks

D. Papadimitriou (Editor)  
Alcatel

S. Yasukawa (Editor)  
NTT

January 2007

## Extensions to RSVP-TE for Point-to-Multipoint TE LSPs

[draft-ietf-mpls-rsvp-te-p2mp-07.txt](#)

### Status of this Memo

By submitting this Internet-Draft, each author represents that any applicable patent or other IPR claims of which he or she is aware have been or will be disclosed, and any of which he or she becomes aware will be disclosed, in accordance with [Section 6 of BCP 79](#).

Internet-Drafts are working documents of the Internet Engineering Task Force (IETF), its areas, and its working groups. Note that other groups may also distribute working documents as Internet-Drafts.

Internet-Drafts are draft documents valid for a maximum of six months and may be updated, replaced, or obsoleted by other documents at any time. It is inappropriate to use Internet-Drafts as reference material or to cite them other than as "work in progress."

The list of current Internet-Drafts can be accessed at <http://www.ietf.org/ietf/1id-abstracts.txt>.

The list of Internet-Draft Shadow Directories can be accessed at <http://www.ietf.org/shadow.html>.

### Abstract

This document describes extensions to Resource Reservation Protocol - Traffic Engineering (RSVP-TE) for the set up of Traffic Engineered (TE) point-to-multipoint (P2MP) Label Switched Paths (LSPs) in Multi-Protocol Label Switching (MPLS) and Generalized MPLS (GMPLS) networks. The solution relies on RSVP-TE without requiring a multicast routing protocol in the Service Provider core. Protocol

elements and procedures for this solution are described.

There can be various applications for P2MP TE LSPs such as IP multicast. Specification of how such applications will use a P2MP TE LSP is outside the scope of this document.

## Table of Contents

<a href="#">1</a>	Conventions used in this document .....	<a href="#">5</a>
<a href="#">2</a>	Terminology .....	<a href="#">5</a>
<a href="#">3</a>	Introduction .....	<a href="#">5</a>
<a href="#">4</a>	Mechanism .....	<a href="#">6</a>
<a href="#">4.1</a>	P2MP Tunnels .....	<a href="#">6</a>
<a href="#">4.2</a>	P2MP LSP .....	<a href="#">6</a>
<a href="#">4.3</a>	Sub-Groups .....	<a href="#">7</a>
<a href="#">4.4</a>	S2L Sub-LSPs .....	<a href="#">7</a>
<a href="#">4.4.1</a>	Representation of an S2L Sub-LSP .....	<a href="#">7</a>
<a href="#">4.4.2</a>	S2L Sub-LSPs and Path Messages .....	<a href="#">8</a>
<a href="#">4.5</a>	Explicit Routing .....	<a href="#">8</a>
<a href="#">5</a>	Path Message .....	<a href="#">11</a>
<a href="#">5.1</a>	Path Message Format .....	<a href="#">11</a>
<a href="#">5.2</a>	Path Message Processing .....	<a href="#">12</a>
<a href="#">5.2.1</a>	Multiple Path Messages .....	<a href="#">12</a>
<a href="#">5.2.2</a>	Multiple S2L Sub-LSPs in one Path message .....	<a href="#">13</a>
<a href="#">5.2.3</a>	Transit Fragmentation of Path State Information .....	<a href="#">15</a>
<a href="#">5.2.4</a>	Control of Branch Fate Sharing .....	<a href="#">16</a>
<a href="#">5.3</a>	Grafting .....	<a href="#">16</a>
<a href="#">6</a>	Resv Message .....	<a href="#">17</a>
<a href="#">6.1</a>	Resv Message Format .....	<a href="#">17</a>
<a href="#">6.2</a>	Resv Message Processing .....	<a href="#">18</a>
<a href="#">6.2.1</a>	Resv Message Throttling .....	<a href="#">19</a>
<a href="#">6.3</a>	Route Recording .....	<a href="#">20</a>
<a href="#">6.3.1</a>	RRO Processing .....	<a href="#">20</a>
<a href="#">6.4</a>	Reservation Style .....	<a href="#">20</a>
<a href="#">7</a>	PathTear Message .....	<a href="#">21</a>
<a href="#">7.1</a>	PathTear Message Format .....	<a href="#">21</a>
<a href="#">7.2</a>	Pruning .....	<a href="#">21</a>
<a href="#">7.2.1</a>	Implicit S2L Sub-LSP Teardown .....	<a href="#">21</a>
<a href="#">7.2.2</a>	Explicit S2L Sub-LSP Teardown .....	<a href="#">22</a>
<a href="#">8</a>	Notify and ResvConf Messages .....	<a href="#">22</a>
<a href="#">8.1</a>	Notify Messages .....	<a href="#">22</a>
<a href="#">8.2</a>	ResvConf Messages .....	<a href="#">24</a>
<a href="#">9</a>	Refresh Reduction .....	<a href="#">25</a>
<a href="#">10</a>	State Management .....	<a href="#">25</a>
<a href="#">10.1</a>	Incremental State Update .....	<a href="#">25</a>
<a href="#">10.2</a>	Combining Multiple Path Messages .....	<a href="#">26</a>
<a href="#">11</a>	Error Processing .....	<a href="#">27</a>
<a href="#">11.1</a>	PathErr Messages .....	<a href="#">27</a>
<a href="#">11.2</a>	ResvErr Messages .....	<a href="#">28</a>
<a href="#">11.3</a>	Branch Failure Handling .....	<a href="#">29</a>
<a href="#">12</a>	Admin Status Change .....	<a href="#">30</a>



<a href="#">13</a>	Label Allocation on LANs with Multiple Downstream Nodes ..	<a href="#">30</a>
<a href="#">14</a>	P2MP LSP and Sub-LSP Re-optimization .....	<a href="#">30</a>
<a href="#">14.1</a>	Make-before-break .....	<a href="#">30</a>
<a href="#">14.2</a>	Sub-Group Based Re-optimization .....	<a href="#">31</a>
<a href="#">15</a>	Fast Reroute .....	<a href="#">31</a>
<a href="#">15.1</a>	Facility Backup .....	<a href="#">32</a>
<a href="#">15.1.1</a>	Link Protection .....	<a href="#">32</a>
<a href="#">15.1.2</a>	Node Protection .....	<a href="#">32</a>
<a href="#">15.2</a>	one-to-one Backup .....	<a href="#">33</a>
<a href="#">16</a>	Support for LSRs that are not P2MP Capable .....	<a href="#">34</a>
<a href="#">17</a>	<b>Reduction in Control Plane Processing with LSP Hierarchy.</b>	<a href="#">36</a>
<a href="#">18</a>	P2MP LSP Remerging and Cross-Over .....	<a href="#">36</a>
<a href="#">18.1</a>	Procedures .....	<a href="#">37</a>
<a href="#">18.1.1</a>	Re-Merge Procedures .....	<a href="#">38</a>
<a href="#">19</a>	New and Updated Message Objects .....	<a href="#">40</a>
<a href="#">19.1</a>	SESSION Object .....	<a href="#">40</a>
<a href="#">19.1.1</a>	P2MP LSP Tunnel IPv4 SESSION Object .....	<a href="#">40</a>
<a href="#">19.1.2</a>	P2MP LSP Tunnel IPv6 SESSION Object .....	<a href="#">41</a>
<a href="#">19.2</a>	SENDER_TEMPLATE object .....	<a href="#">41</a>
<a href="#">19.2.1</a>	P2MP LSP Tunnel IPv4 SENDER_TEMPLATE Object .....	<a href="#">42</a>
<a href="#">19.2.2</a>	P2MP LSP Tunnel IPv6 SENDER_TEMPLATE Object .....	<a href="#">42</a>
<a href="#">19.3</a>	S2L_SUB_LSP Object .....	<a href="#">43</a>
<a href="#">19.3.1</a>	S2L_SUB_LSP IPv4 Object .....	<a href="#">44</a>
<a href="#">19.3.2</a>	S2L_SUB_LSP IPv6 Object .....	<a href="#">44</a>
<a href="#">19.4</a>	FILTER_SPEC Object .....	<a href="#">44</a>
<a href="#">19.4.1</a>	P2MP LSP_IPv4 FILTER_SPEC Object .....	<a href="#">44</a>
<a href="#">19.4.2</a>	P2MP LSP_IPv6 FILTER_SPEC Object .....	<a href="#">45</a>
<a href="#">19.5</a>	P2MP SECONDARY_EXPLICIT_ROUTE Object (SERO) .....	<a href="#">45</a>
<a href="#">19.6</a>	P2MP SECONDARY_RECORD_ROUTE Object (SRR0) .....	<a href="#">45</a>
<a href="#">20</a>	IANA Considerations .....	<a href="#">45</a>
<a href="#">20.1</a>	New Class Numbers .....	<a href="#">45</a>
<a href="#">20.2</a>	New Class Types .....	<a href="#">46</a>
<a href="#">20.3</a>	New Error Values .....	<a href="#">46</a>
<a href="#">20.4</a>	LSP Attributes Flags .....	<a href="#">47</a>
<a href="#">21</a>	Security Considerations .....	<a href="#">47</a>
<a href="#">22</a>	Acknowledgements .....	<a href="#">48</a>
<a href="#">23</a>	References .....	<a href="#">48</a>
<a href="#">23.1</a>	Normative References .....	<a href="#">48</a>
<a href="#">23.2</a>	Informative References .....	<a href="#">49</a>
<a href="#">24</a>	Appendix .....	<a href="#">50</a>
<a href="#">24.1</a>	Example .....	<a href="#">50</a>
<a href="#">25</a>	Author Information .....	<a href="#">51</a>
<a href="#">25.1</a>	Editor Information .....	<a href="#">51</a>
<a href="#">25.2</a>	Contributor Information .....	<a href="#">52</a>
<a href="#">26</a>	Intellectual Property .....	<a href="#">54</a>
<a href="#">27</a>	Full Copyright Statement .....	<a href="#">54</a>
<a href="#">28</a>	Acknowledgement .....	<a href="#">55</a>



## **1. Conventions used in this document**

The key words "MUST", "MUST NOT", "REQUIRED", "SHALL", "SHALL NOT", "SHOULD", "SHOULD NOT", "RECOMMENDED", "MAY", and "OPTIONAL" in this document are to be interpreted as described in [RFC-2119](#) [[RFC2119](#)].

## **2. Terminology**

This document uses terminologies defined in [[RFC3031](#)], [[RFC2205](#)], [[RFC3209](#)], [[RFC3473](#)], [[RFC4461](#)] and [[RFC4090](#)].

## **3. Introduction**

[[RFC3209](#)] defines a mechanism for setting up point-to-point (P2P) Traffic Engineered (TE) Label Switched Paths (LSPs) in Multi-Protocol Label Switching (MPLS) networks. [[RFC3473](#)] defines extensions to [[RFC3209](#)] for setting up P2P TE LSPs in Generalized MPLS (GMPLS) networks. However these specifications do not provide a mechanism for building point-to-multipoint (P2MP) TE LSPs.

This document defines extensions to the RSVP-TE protocol [[RFC3209](#)], [[RFC3473](#)] to support P2MP TE LSPs satisfying the set of requirements described in [[RFC4461](#)].

This document relies on the semantics of the Resource Reservation Protocol (RSVP) that RSVP-TE inherits for building P2MP LSPs. A P2MP LSP is comprised of multiple source-to-leaf (S2L) sub-LSPs. These S2L sub-LSPs are set up between the ingress and egress-LSRs and are appropriately combined by the branch LSRs using RSVP semantics to result in a P2MP TE LSP. One Path message may signal one or multiple S2L sub-LSPs for a single P2MP LSP. Hence the S2L sub-LSPs belonging to a P2MP LSP can be signaled using one Path message or split across multiple Path messages.

There are various applications for P2MP TE LSPs and the signaling techniques described in this document can be used, sometimes in combination with other techniques, to support different applications.

Specification of how applications will use P2MP TE LSPs and how the paths of P2MP TE LSPs are computed is outside the scope of this document.





## **4. Mechanism**

This document describes a solution that optimizes data replication by allowing non-ingress nodes in the network to be replication/branch nodes. A branch node is an LSR that replicates the incoming data on to one or more outgoing interfaces. The solution relies on RSVP-TE in the network for setting up a P2MP TE LSP.

The P2MP TE LSP is set up by associating multiple S2L sub-LSPs and relying on data replication at branch nodes. This is described further in the following sub-sections by describing P2MP Tunnels and how they relate to S2L sub-LSPs.

### **4.1. P2MP Tunnels**

The defining feature of a P2MP TE LSP is the action required at branch nodes where data replication occurs. Incoming MPLS labeled data is replicated to outgoing interfaces which may use different labels for the data.

A P2MP TE Tunnel comprises one or more P2MP LSPs. A P2MP TE Tunnel is identified by a P2MP SESSION object. This object contains the identifier of the P2MP Session which includes the P2MP Identifier (P2MP ID), a tunnel Identifier (Tunnel ID) and an extended tunnel identifier (Extended Tunnel ID). The P2MP ID is a four octet number and is unique within the scope of the ingress LSR.

The <P2MP ID, Tunnel ID, Extended Tunnel ID> tuple provides an identifier for the set of destinations of the P2MP TE Tunnel.

The fields of the P2MP SESSION object are identical to those of the SESSION object defined in [[RFC3209](#)] except that the Tunnel Endpoint Address field is replaced by the P2MP ID field. The P2MP SESSION object is defined in [section 19.1](#)

### **4.2. P2MP LSP**

A P2MP LSP is identified by the combination of the P2MP ID, Tunnel ID and Extended Tunnel ID that are part of the P2MP SESSION object, and the tunnel sender address and LSP ID fields of the P2MP SENDER\_TEMPLATE object. The new P2MP SENDER\_TEMPLATE object is defined in [section 19.2](#).



### **[4.3. Sub-Groups](#)**

As with all other RSVP controlled LSPs, P2MP LSP state is managed using RSVP messages. While the use of RSVP messages is the same, P2MP LSP state differs from P2P LSP state in a number of ways. A P2MP LSP comprises multiple S2L Sub-LSPs and as a result of this it may not be possible to represent full state in a single IP packet. It must also be possible to efficiently add and remove endpoints to and from P2MP TE LSPs. An additional issue is that the P2MP LSP must also handle the state "remerge" problem, see [[RFC4461](#)] and [section 18](#).

These differences in P2MP state are addressed through the addition of a sub-group identifier (Sub-Group ID) and sub-group originator (Sub-Group Originator ID) to the SENDER\_TEMPLATE and FILTER\_SPEC objects. Taken together the Sub-Group ID and Sub-Group Originator ID are referred to as the Sub-Group fields.

The Sub-Group fields, together with rest of the SENDER\_TEMPLATE and SESSION objects, are used to represent a portion of a P2MP LSP's state. This portion of a P2MP LSP's state refers only to signaling state and not data plane replication or branching. For example, it is possible for a node to "branch" signaling state for a P2MP LSP, but to not branch the data associated with the P2MP LSP. Typical applications for generation and use of multiple sub-groups are adding an egress, and semantic fragmentation to ensure that a Path message remains within a single IP packet.

### **[4.4. S2L Sub-LSPs](#)**

A P2MP LSP is constituted of one or more S2L sub-LSPs.

#### **[4.4.1. Representation of an S2L Sub-LSP](#)**

An S2L sub-LSP exists within the context of a P2MP LSP. Thus it is identified by the P2MP ID, Tunnel ID, and Extended Tunnel ID that are part of the P2MP SESSION, the tunnel sender address and LSP ID fields of the P2MP SENDER\_TEMPLATE object, and the S2L sub-LSP destination address that is part of the S2L\_SUB\_LSP object. The S2L\_SUB\_LSP object is defined in [section 19.3](#).

An EXPLICIT\_ROUTE Object (ERO) or P2MP\_SECONDARY\_EXPLICIT\_ROUTE Object (SERO) is used to optionally specify the explicit route of a S2L sub-LSP. Each ERO or SERO that is signaled corresponds to a particular S2L\_SUB\_LSP object. Details of explicit route encoding are specified in [section 4.5](#). The SECONDARY\_EXPLICIT\_ROUTE Object is defined in [[RECOVERY](#)], a new P2MP SECONDARY\_EXPLICIT\_ROUTE Object C-



type is defined in [Section 19.5](#) and a matching P2MP\_SECONDARY\_RECORD\_ROUTE Object C-type is defined in [Section 19.6](#).

#### **[4.4.2. S2L Sub-LSPs and Path Messages](#)**

The mechanism in this document allows a P2MP LSP to be signaled using one or more Path messages. Each Path message may signal one or more S2L sub-LSPs. Support for multiple Path messages is desirable as one Path message may not be large enough to contain all the S2L sub-LSPs; and they also allow separate manipulation of sub-trees of the P2MP LSP. The reason for allowing a single Path message, to signal multiple S2L sub-LSPs, is to optimize the number of control messages needed to set up a P2MP LSP.

#### **[4.5. Explicit Routing](#)**

When a Path message signals a single S2L sub-LSP (that is, the Path message is only targeting a single leaf in the P2MP tree), the EXPLICIT\_ROUTE object encodes the path to the egress-LSR. The Path message also includes the S2L\_SUB\_LSP object for the S2L sub-LSP being signaled. The < [[EXPLICIT\\_ROUTE](#)], [S2L\\_SUB\\_LSP](#) > tuple represents the S2L sub-LSP and is referred to as the sub-LSP descriptor. The absence of the ERO should be interpreted as requiring hop-by-hop routing for the sub-LSP based on the S2L sub-LSP destination address field of the S2L\_SUB\_LSP object.

When a Path message signals multiple S2L sub-LSPs the path of the first S2L sub-LSP, to the egress-LSR, is encoded in the ERO. The first S2L sub-LSP is the one that corresponds to the first S2L\_SUB\_LSP object in the Path message. The S2L sub-LSPs corresponding to the S2L\_SUB\_LSP objects that follow are termed as subsequent S2L sub-LSPs.

The path of each subsequent S2L sub-LSP is encoded in a P2MP\_SECONDARY\_EXPLICIT\_ROUTE object (SERO). The format of the SERO is the same as an ERO (as defined in [[RFC3209](#)] and [[RFC3473](#)]). Each subsequent S2L sub-LSP is represented by tuples of the form < [[P2MP\\_SECONDARY\\_EXPLICIT\\_ROUTE](#)] [S2L\\_SUB\\_LSP](#) >. An SERO for a particular S2L sub-LSP includes only the path from a branch LSR to the egress-LSR of that S2L sub-LSP. The branch MUST appear as an explicit hop in the ERO or some other SERO. The absence of an SERO should be interpreted as requiring hop-by-hop routing for that S2L sub-LSP. Note that the destination address is carried in the S2L sub-LSP object. The encoding of the SERO and S2L\_SUB\_LSP object are described in detail in [section 19](#).



In order to avoid the potential repetition of path information for the parts of S2L sub-LSPs that share hops, this information is deduced from the explicit routes of other S2L sub-LSPs using explicit route compression in SEROs.

Explicit route compression is illustrated using Figure 1.

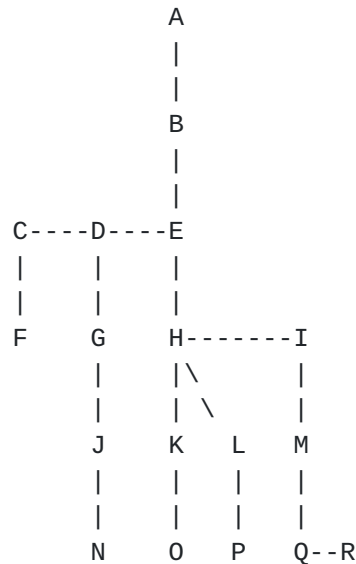

Figure 1. Explicit Route Compression

Figure 1. shows a P2MP LSP with LSR A as the ingress-LSR and six egress LSRs: (F, N, O, P, Q and R). When all the six S2L sub-LSPs are signaled in one Path message let us assume that the S2L sub-LSP to LSR F is the first S2L sub-LSP and the rest are subsequent S2L sub-LSPs. The following encoding is one way for the ingress-LSR A to encode the S2L sub-LSP explicit routes using compression:

- S2L sub-LSP-F: ERO = {B, E, D, C, F}, <S2L\_SUB\_LSP> object-F
- S2L sub-LSP-N: SERO = {D, G, J, N}, <S2L\_SUB\_LSP> object-N
- S2L sub-LSP-O: SERO = {E, H, K, O}, <S2L\_SUB\_LSP> object-O
- S2L sub-LSP-P: SERO = {H, L, P}, <S2L\_SUB\_LSP> object-P,
- S2L sub-LSP-Q: SERO = {H, I, M, Q}, <S2L\_SUB\_LSP> object-Q,
- S2L sub-LSP-R: SERO = {Q, R}, <S2L\_SUB\_LSP> object-R,

After LSR E processes the incoming Path message from LSR B it sends a Path message to LSR D with the S2L sub-LSP explicit routes encoded as follows:

- S2L sub-LSP-F: ERO = {D, C, F}, <S2L\_SUB\_LSP> object-F
- S2L sub-LSP-N: SERO = {D, G, J, N}, <S2L\_SUB\_LSP> object-N





LSR E also sends a Path message to LSR H and following is one way to encode the S2L sub-LSP explicit routes using compression:

```
S2L sub-LSP-O:  ERO = {H, K, O}, <S2L_SUB_LSP> object-O
S2L sub-LSP-P:  SERO = {H, L, P}, S2L_SUB_LSP object-P,
S2L sub-LSP-Q:  SERO = {H, I, M, Q}, <S2L_SUB_LSP> object-Q,
S2L sub-LSP-R:  SERO = {Q, R}, <S2L_SUB_LSP> object-R,
```

After LSR H processes the incoming Path message from E it sends a Path message to LSR K, LSR L and LSR I. The encoding for the Path message to LSR K is as follows:

```
S2L sub-LSP-O:  ERO = {K, O}, <S2L_SUB_LSP> object-O
```

The encoding of the Path message sent by LSR H to LSR L is as follows:

```
S2L sub-LSP-P:  ERO = {L, P}, <S2L_SUB_LSP> object-P,
```

The following encoding is one way for LSR H to encode the S2L sub-LSP explicit routes in the Path message sent to LSR I:

```
S2L sub-LSP-Q:  ERO = {I, M, Q}, <S2L_SUB_LSP> object-Q,
S2L sub-LSP-R:  SERO = {Q, R}, <S2L_SUB_LSP> object-R,
```

The explicit route encodings in the Path messages sent by LSRs D and Q are left as an exercise for the reader.

This compression mechanism reduces the Path message size. It also reduces extra processing that can result if explicit routes are encoded from ingress to egress for each S2L sub-LSP. No assumptions are placed on the ordering of the subsequent S2L sub-LSPs and hence on the ordering of the SEROs in the Path message. All LSRs need to process the ERO corresponding to the first S2L sub-LSP. An LSR needs to process an S2L sub-LSP descriptor for a subsequent S2L sub-LSP only if the first hop in the corresponding SERO is a local address of that LSR. The branch LSR that is the first hop of an SERO propagates the corresponding S2L sub-LSP downstream.



## 5. Path Message

### 5.1. Path Message Format

This section describes modifications made to the Path message format as specified in [RFC3209] and [RFC3473]. The Path message is enhanced to signal one or more S2L sub-LSPs. This is done by including the S2L sub-LSP descriptor list in the Path message as shown below.

```
<Path Message> ::=
    <Common Header> [ <INTEGRITY> ]
    [ [<MESSAGE_ID_ACK> | <MESSAGE_ID_NACK>] ...]
    [ <MESSAGE_ID> ]
    <SESSION> <RSVP_HOP>
    <TIME_VALUES>
    [ <EXPLICIT_ROUTE> ]
    <LABEL_REQUEST>
    [ <PROTECTION> ]
    [ <LABEL_SET> ... ]
    [ <SESSION_ATTRIBUTE> ]
    [ <NOTIFY_REQUEST> ]
    [ <ADMIN_STATUS> ]
    [ <POLICY_DATA> ... ]
    <sender descriptor>
    [<S2L sub-LSP descriptor list>]
```

Following is the format of the S2L sub-LSP descriptor list.

```
<S2L sub-LSP descriptor list> ::= <S2L sub-LSP descriptor>
    [ <S2L sub-LSP descriptor list> ]

<S2L sub-LSP descriptor> ::= <S2L_SUB_LSP>
    [ <P2MP SECONDARY_EXPLICIT_ROUTE> ]
```

Each LSR MUST use the common objects in the Path message and the S2L sub-LSP descriptors to process each S2L sub-LSP represented by the S2L\_SUB\_LSP object and the SECONDARY-/EXPLICIT\_ROUTE object combination.

Per the definition of <S2L sub-LSP descriptor>, each S2L\_SUB\_LSP object MAY be followed by a corresponding SERO. The first S2L\_SUB\_LSP object is a special case, and its explicit route is specified by the ERO. Therefore, the first S2L\_SUB\_LSP object SHOULD NOT be followed by an SERO, and if one is present it MUST be ignored.

The RRO in the sender descriptor contains the upstream hops traversed by the Path message and applies to all the S2L sub-LSPs signaled in the Path message.



An IF\_ID RSVP\_HOP object MUST be used on links where there is not a one-to-one association of a control channel to a data channel [[RFC3471](#)]. An RSVP\_HOP object defined in [[RFC2205](#)] SHOULD be used otherwise.

Path message processing is described in the next section.

## **5.2. Path Message Processing**

The ingress-LSR initiates the setup of an S2L sub-LSP to each egress-LSR that is a destination of the P2MP LSP. Each S2L sub-LSP is associated with the same P2MP LSP using common P2MP SESSION object and <Sender Address, LSP-ID> fields in the P2MP SENDER\_TEMPLATE object. Hence it can be combined with other S2L sub-LSPs to form a P2MP LSP. Another S2L sub-LSP belonging to the same instance of this S2L sub-LSP (i.e. the same P2MP LSP) SHOULD share resources with this S2L sub-LSP. The session corresponding to the P2MP TE tunnel is determined based on the P2MP SESSION object. Each S2L sub-LSP is identified using the S2L\_SUB\_LSP object. Explicit routing for the S2L sub-LSPs is achieved using the ERO and SEROs.

As mentioned earlier, it is possible to signal S2L sub-LSPs for a given P2MP LSP in one or more Path messages and a given Path message can contain one or more S2L sub-LSPs. An LSR that supports RSVP-TE signaled P2MP LSPs MUST be able to receive and process multiple Path messages for the same P2MP LSP and multiple S2L sub-LSPs in one Path message. This implies that such an LSR MUST be able to receive and process all objects listed in [section 19](#).

### **5.2.1. Multiple Path Messages**

As described in [section 4](#), either the < [[EXPLICIT\\_ROUTE](#)] <S2L\_SUB\_LSP> > or the < [[P2MP\\_SECONDARY\\_EXPLICIT\\_ROUTE](#)] <S2L\_SUB\_LSP> > tuple is used to specify an S2L sub-LSP. Multiple Path messages can be used to signal a P2MP LSP. Each Path message can signal one or more S2L sub-LSPs. If a Path message contains only one S2L sub-LSP, each LSR along the S2L sub-LSP follows [[RFC3209](#)] procedures for processing the Path message besides the S2L\_SUB\_LSP object processing described in this document.

Processing of Path messages containing more than one S2L sub-LSP is described in [Section 5.2.2](#).

An ingress-LSR MAY use multiple Path messages for signaling a P2MP LSP. This may be because a single Path message may not be large enough to signal the P2MP LSP. Or it may be while adding leaves to



the P2MP LSP the new leaves are signaled in a new Path message. Or an ingress LSR MAY choose to break the P2MP tree into separate manageable P2MP trees. These trees share the same root and may share the trunk and certain branches. The scope of this management decomposition of P2MP trees is bounded by a single tree (the P2MP Tree) and multiple trees with a single leaf each (S2L sub-LSPs). Per [RFC4461], a P2MP LSP MUST have consistent attributes across all portions of a tree. This implies that each Path message that is used to signal a P2MP LSP is signaled using the same signaling attributes with the exception of the S2L sub-LSP descriptors and Sub-Group identifier.

The resulting sub-LSPs from the different Path messages belonging to the same P2MP LSP SHOULD share labels and resources where they share hops to prevent multiple copies of the data being sent.

In certain cases a transit LSR may need to generate multiple Path messages to signal state corresponding to a single received Path message. For instance ERO expansion may result in an overflow of the resultant Path message. In this case the message can be decomposed into multiple Path messages such that each message carries a subset of the X2L sub-tree carried by the incoming message.

Multiple Path messages generated by an LSR that signal state for the same P2MP LSP are signaled with the same SESSION object and have the same <Source address, LSP-ID> in the SENDER\_TEMPLATE object. In order to disambiguate these Path messages a <Sub-Group Originator ID, Sub-Group ID> tuple is introduced (also referred to as the Sub-Group fields) and encoded in the SENDER\_TEMPLATE object. Multiple Path messages generated by an LSR to signal state for the same P2MP LSP have the same Sub-Group Originator ID and have a different sub-Group ID. The Sub-Group Originator ID MUST be set to the TE Router ID of the LSR that originates the Path message. Cases when a transit LSR may change the Sub-Group Originator ID of an incoming Path message are described below. The Sub-Group Originator ID is globally unique. The sub-Group ID space is specific to the Sub-Group Originator ID.

### **5.2.2. Multiple S2L Sub-LSPs in one Path message**

The S2L sub-LSP descriptor list allows the signaling of one or more S2L sub-LSPs in one Path message. Each S2L sub-LSP descriptor describes a single S2L sub-LSP.

All LSRs MUST process the ERO corresponding to the first S2L sub-LSP if the ERO is present. If one or more SEROs are present an ERO MUST be present. The first S2L sub-LSP MUST be propagated in a Path message by each LSR along the explicit route specified by the ERO, if





the ERO is present. Else it MUST be propagated using hop-by-hop routing towards the destination identified by the S2L\_SUB\_LSP object.

An LSR MUST process a S2L sub-LSP descriptor for a subsequent S2L sub-LSP as follows:

If the S2L\_SUB\_LSP object is followed by an SERO, the LSR MUST check the first hop in the SERO:

- If the first hop of the SERO identifies a local address of the LSR, and the LSR is also the egress identified by the S2L\_SUB\_LSP object, the descriptor MUST NOT be propagated downstream, but the SERO may be used for egress control per [\[RFC4003\]](#).
- If the first hop of the SERO identifies a local address of the LSR, and the LSR is not the egress as identified by the S2L\_SUB\_LSP object, the S2L sub-LSP descriptor MUST be included in a Path message sent to the next-hop determined from the SERO.
- If the first hop of the SERO is not a local address of the LSR, the S2L sub-LSP descriptor MUST be included in the Path message sent to the LSR that is the next hop to reach the first hop in the SERO. This next hop is determined by using the ERO or other SEROs that encode the path to the SERO's first hop.

If the S2L\_SUB\_LSP object is not followed by an SERO, the LSR MUST examine the S2L\_SUB\_LSP object:

- If this LSR is the egress as identified by the S2L\_SUB\_LSP object, the S2L sub-LSP descriptor MUST NOT be propagated downstream.
- If this LSR is not the egress as identified by the S2L\_SUB\_LSP object, the LSR MUST make a routing decision to determine the next hop towards the egress, and MUST include the S2L sub-LSP descriptor in a Path message sent to the next-hop towards the egress. In this case, the LSR MAY insert an SERO into the S2L sub-LSP descriptor.

Hence a branch LSR MUST only propagate the relevant S2L sub-LSP descriptors to each downstream hop. An S2L sub-LSP descriptor list that is propagated on a downstream link MUST only contain those S2L sub-LSPs that are routed using that hop. This processing MAY result in a subsequent S2L sub-LSP in an incoming Path message becoming the first S2L sub-LSP in an outgoing Path message.

Note that if one or more SEROs contain loose hops, expansion of such loose hops MAY result in overflowing the Path message size. [Section 5.2.3](#) describes how signaling of the set of S2L sub-LSPs can be split across more than one Path message.



The RECORD\_ROUTE Object (RRO) contains the hops traversed by the Path message and applies to all the S2L sub-LSPs signaled in the Path message. A transit LSR MUST append its address in an incoming RRO and propagate it downstream. A branch LSR MUST form a new RRO for each of the outgoing Path messages by copying the RRO from the incoming Path message and appending its address. Each such updated RRO MUST be formed using the rules in [[RFC3209](#)] updated by [[RFC3473](#)] as appropriate.

If an LSR is unable to support an S2L sub-LSP in a Path message (for example, it is unable to route towards the destination using the SERO), a PathErr message MUST be sent for the impacted S2L sub-LSP, and normal processing of the rest of the P2MP LSP SHOULD continue. The default behavior is that the remainder of the LSP is not impacted (that is, all other branches are allowed to set up) and the failed branches are reported in PathErr messages in which the Path\_State\_Removed flag MUST NOT be set. However, the ingress-LSR may set an LSP Integrity flag to request that if there is a setup failure on any branch the entire LSP should fail to set up. This is described further in sections [5.2.4](#) and [11](#).

### **[5.2.3](#). Transit Fragmentation of Path State Information**

In certain cases a transit LSR may need to generate multiple Path messages to signal state corresponding to a single received Path message. For instance ERO expansion may result in an overflow of the resultant Path message. RSVP [[RFC2205](#)] disallows the use of IP fragmentation and thus IP fragmentation MUST be avoided in this case. In order to achieve this, the multiple Path messages generated by the transit LSR, are signaled with the Sub-Group Originator ID set to the TE Router ID of the transit LSR and a distinct Sub-Group ID for each Path message. Thus each distinct Path message that is generated by the transit LSR for the P2MP LSP carries a distinct <Sub-Group Originator ID, Sub-Group ID> tuple.

When multiple Path messages are used by an ingress or transit node, each Path message SHOULD be identical with the exception of the S2L sub-LSP related descriptor (e.g., SERO), message and hop information (e.g., INTEGRITY, MESSAGE\_ID and RSVP\_HOP), and the sub-group fields of the SENDER\_TEMPLATE objects. Except when performing a make-before-break operation as specified in [section 14.1](#), the tunnel sender address and LSP ID fields MUST be the same in each message, and for transit nodes, the same as the values in the received Path message.

As described above one case in which the Sub-Group Originator ID of a received Path message is changed is that of fragmentation of a Path



message at a transit node. Another case is when the Sub-Group Originator ID of a received Path message may be changed in the outgoing Path message and set to that of the LSR originating the Path message based on a local policy. For instance an LSR may decide to always change the Sub-Group Originator ID while performing ERO expansion. The Sub-Group ID MUST not be changed if the Sub-Group Originator ID is not changed.

#### **5.2.4. Control of Branch Fate Sharing**

An ingress-LSR can control the behavior of an LSP if there is a failure during LSP setup or after an LSP has been established. The default behavior is that only the branches downstream of the failure are not established, but the ingress may request 'LSP integrity' such that any failure anywhere within the LSP tree causes the entire P2MP LSP to fail.

The ingress LSP may request 'LSP integrity' by setting bit TBD of the Attributes Flags TLV. (RFC Editor, please replace "TBD" with the bit number allocated by IANA per [section 20.4](#). Please remove this note.) The bit is set if LSP integrity is required.

It is RECOMMENDED to use the LSP\_REQUIRED\_ATTRIBUTES Object [[RFC4420](#)].

A branch LSR that supports the Attributes Flags TLV and recognizes this bit MUST support LSP integrity or reject the LSP setup with a PathErr message carrying the error "Routing Error"/"Unsupported LSP Integrity"

#### **5.3. Grafting**

The operation of adding egress-LSR(s) to an existing P2MP LSP is termed as grafting. This operation allows egress nodes to join a P2MP LSP at different points in time.

There are two methods to add S2L sub-LSPs to a P2MP LSP. The first is to add new S2L sub-LSPs to the P2MP LSP by adding them to an existing Path message and refreshing the entire Path message. Path message processing described in [section 4](#) results in adding these S2L sub-LSPs to the P2MP LSP. Note that as a result of adding one or more S2L sub-LSPs to a Path message the ERO compression encoding may have to be recomputed.

The second is to use incremental updates described in [section 10.1](#). The egress LSRs can be added by signaling only the impacted S2L sub-



LSPs in a new Path message. Hence other S2L sub-LSPs do not have to be re-signaled.

## 6. Resv Message

### 6.1. Resv Message Format

The Resv message follows the [[RFC3209](#)] and [[RFC3473](#)] format:

```
<Resv Message> ::=
    <Common Header> [ <INTEGRITY> ]
    [ [ <MESSAGE_ID_ACK> | <MESSAGE_ID_NACK> ] ... ]
    [ <MESSAGE_ID> ]
    <SESSION> <RSVP_HOP>
    <TIME_VALUES>
    [ <RESV_CONFIRM> ] [ <SCOPE> ]
    [ <NOTIFY_REQUEST> ]
    [ <ADMIN_STATUS> ]
    [ <POLICY_DATA> ... ]
    <STYLE> <flow descriptor list>
```

```
<flow descriptor list> ::= <FF flow descriptor list>
    | <SE flow descriptor>
```

```
<FF flow descriptor list> ::= <FF flow descriptor>
    | <FF flow descriptor list>
    <FF flow descriptor>
```

```
<SE flow descriptor> ::= <FLOWSPEC> <SE filter spec list>
```

```
<SE filter spec list> ::= <SE filter spec>
    | <SE filter spec list> <SE filter spec>
```

The FF flow descriptor and SE filter spec are modified as follows to identify the S2L sub-LSPs that they correspond to:

```
<FF flow descriptor> ::= [ <FLOWSPEC> ] <FILTER_SPEC> <LABEL>
    [ <RECORD_ROUTE> ]
    [ <S2L sub-LSP flow descriptor list> ]
```

```
<SE filter spec> ::= <FILTER_SPEC> <LABEL> [ <RECORD_ROUTE> ]
    [ <S2L sub-LSP flow descriptor list> ]
```

```
<S2L sub-LSP flow descriptor list> ::=
    <S2L sub-LSP flow descriptor>
```





[ <S2L sub-LSP flow descriptor list> ]

<S2L sub-LSP flow descriptor> ::= <S2L\_SUB\_LSP>  
[ <P2MP\_SECONDARY\_RECORD\_ROUTE> ]

FILTER\_SPEC is defined in [section 19.4](#).

The S2L sub-LSP flow descriptor has the same format as S2L sub-LSP descriptor in [section 4.1](#) with the difference that a P2MP\_SECONDARY\_RECORD\_ROUTE object is used in place of a P2MP\_SECONDARY\_EXPLICIT\_ROUTE object. The P2MP\_SECONDARY\_RECORD\_ROUTE objects follow the same compression mechanism as the P2MP\_SECONDARY\_EXPLICIT\_ROUTE objects. Note that a Resv message can signal multiple S2L sub-LSPs that may belong to the same FILTER\_SPEC object or different FILTER\_SPEC objects. The same label SHOULD be allocated if the <Sender Address, LSP-ID> fields of the FILTER\_SPEC object are the same.

However different labels MUST be allocated if the <Sender Address, LSP-ID> of the FILTER\_SPEC object is different as that implies that the FILTER\_SPEC refers to a different P2MP LSP.

## **[6.2](#). Resv Message Processing**

The egress LSR MUST follow normal RSVP procedures while originating a Resv message. The format of Resv messages is as defined in [Section 6.1](#). As usual, the Resv message carries the label allocated by the egress LSR.

A node upstream of the egress node MUST allocate its own label and pass it upstream in the Resv message. The node MAY combine multiple flow descriptors, from different Resv messages received from downstream, in one Resv message sent upstream. A Resv message MUST NOT be sent upstream until at least one Resv message has been received from a downstream neighbor. When the integrity bit is set in the LSP\_REQUIRED\_ATTRIBUTE object, Resv message MUST NOT be sent upstream until all Resv messages have been received from the downstream neighbors.

Each FF flow descriptor or SE filter spec sent upstream in a Resv message includes a S2L sub-LSP descriptor list. Each such FF flow descriptor or SE filter spec for the same P2MP LSP (whether on one or multiple Resv messages) on the same Resv MUST be allocated the same label, and FF flow descriptors or SE filter specs SHOULD use the same label across multiple Resv messages.

This label is associated by that node with all the labels received



from downstream Resv messages for that P2MP LSP. Note that a transit node may become a replication point in the future when a branch is attached to it. Hence this results in the setup of a P2MP LSP from the ingress-LSR to the egress-LSRs.

The ingress-LSR may need to understand when all desired egresses have been reached. This is achieved using S2L\_SUB\_LSP objects.

Each branch node MAY forward a single Resv message upstream for each received Resv message from a downstream receiver. Note that there may be a large number of Resv messages at and close to the ingress LSR for an LSP with many receivers. A branch LSR SHOULD combine Resv state from multiple receivers into a single Resv message to be sent upstream (see [section 6.2.1](#)), but note that this may result in overflowing the Resv message particularly as the number of receivers downstream of any branch LSR increases as the LSR is closer to the ingress LSR. Thus, a branch LSR MAY choose to send more than one Resv message upstream and partition the Resv state between the messages.

When a transit node set the Sub-Group Originator field in a Path message it MUST replace the Sub-Group fields received in the FILTER\_SPEC objects of any associated Resv messages with the value that it originally received in the Sub-Group fields of the Path message from the upstream neighbor.

ResvErr message generation is unmodified. Nodes propagating a received ResvErr message MUST use the Sub-Group field values carried in the corresponding Resv message.

### **[6.2.1](#). Resv Message Throttling**

A branch node may have to send a revised Resv message upstream whenever there is a change in a Resv message for an S2L sub-LSP received from one of the downstream neighbors. This can result in excessive Resv messages sent upstream, particularly when the S2L sub-LSPs are first established. In order to mitigate this situation, branch nodes can limit their transmission of Resv messages.

Specifically, in the case where the only change being sent in a Resv message is in one or more SRRO objects, the branch node SHOULD transmit the Resv message only after a delay time has passed since the transmission of the previous Resv message for the same session. This delayed Resv message SHOULD include SRROs for all branches. A suggested value for the delay time is thirty seconds, and delay times SHOULD generally be longer than 1 second. Specific mechanisms for Resv message throttling and delay timer settings are implementation dependent and are outside the scope of this document.



### **[6.3. Route Recording](#)**

#### **[6.3.1. RRO Processing](#)**

A Resv message for a P2P LSP contains a recorded route if the ingress LSR requested route recording by including an RRO in the original Path message. The same rule is used during signaling of P2MP LSPs. That is, inclusion of an RRO in the Path message used to signal one or more S2L sub-LSPs triggers the inclusion of a recorded route for each sub-LSP in the Resv message.

The recorded route of the first S2L sub-LSP is encoded in the RRO. Additional recorded routes for the subsequent S2L sub-LSPs are encoded in P2MP\_SECONDARY\_RECORD\_ROUTE objects (SRRROs). Their format is specified in [section 19.5](#). Each S2L\_SUB\_LSP object in a Resv is associated with an RRO or SRRRO. The first S2L\_SUB\_LSP object (for the first S2L sub-LSP) is associated with the RRO. Subsequent S2L\_SUB\_LSP objects (for subsequent S2L sub-LSPs) are each followed by an SRRRO that contains the recorded route for that S2L sub-LSP from the leaf to a branch. The ingress node can then use the RRO and SRRROs to determine the end-to-end path for each S2L sub-LSP.

#### **[6.4. Reservation Style](#)**

Considerations about the reservation style in a Resv message apply as described in [[RFC3209](#)]. The reservation style in the Resv messages can be either FF or SE. All P2MP LSPs that belong to the same P2MP Tunnel MUST be signaled with the same reservation style. Irrespective of whether the reservation style is FF or SE, the S2L sub-LSPs that belong to the same P2MP LSP SHOULD share labels where they share hops. If the S2L sub-LSPs that belong to the same P2MP LSP share labels then they MUST share resources. If the reservation style is FF then S2L sub-LSPs that belong to different P2MP LSPs MUST NOT share resources or labels. If the reservation style is SE then S2L sub-LSPs that belong to different P2MP LSPs and the same P2MP Tunnel SHOULD share resources where they share hops, but MUST not share labels in packet environments.



## **7. PathTear Message**

### **7.1. PathTear Message Format**

The format of the PathTear message is as follows:

```
<PathTear Message> ::= <Common Header> [ <INTEGRITY> ]
    [ [ <MESSAGE_ID_ACK> |
        <MESSAGE_ID_NACK> ... ]
      [ <MESSAGE_ID> ]
      <SESSION> <RSVP_HOP>
      [ <sender descriptor> ]
      [ <S2L sub-LSP descriptor list> ]

<S2L sub-LSP descriptor list> ::= <S2L_SUB_LSP>
    [ <S2L sub-LSP descriptor list> ]
```

The definition of <sender descriptor> is not changed by this document.

### **7.2. Pruning**

The operation of removing egress-LSR(s) from an existing P2MP LSP is termed as pruning. This operation allows egress nodes to be removed from a P2MP LSP at different points in time. This section describes the mechanisms to perform pruning.

#### **7.2.1. Implicit S2L Sub-LSP Teardown**

Implicit teardown uses standard RSVP message processing. Per standard RSVP processing, an S2L sub-LSP may be removed from a P2MP TE LSP by sending a modified message for the Path or Resv message that previously advertised the S2L sub-LSP. This message MUST list all S2L sub-LSPs that are not being removed. When using this approach, a node processing a message that removes an S2L sub-LSP from a P2MP TE LSP MUST ensure that the S2L sub-LSP is not included in any other Path state associated with session before interrupting the data path to that egress. All other message processing remains unchanged.

When implicit teardown is used to delete one or more S2L sub-LSPs, by modifying a Path message, a transit LSR may have to generate a PathTear message downstream to delete one or more of these S2L sub-LSPs. This can happen if as a result of the implicit deletion of S2L sub-LSP(s) there are no remaining S2L sub-LSPs to send in the corresponding Path message downstream.





### **7.2.2. Explicit S2L Sub-LSP Teardown**

Explicit S2L Sub-LSP teardown relies on generating a PathTear message for the corresponding Path message. The PathTear message is signaled with the SESSION and SENDER\_TEMPLATE objects corresponding to the P2MP LSP and the <Sub-Group Originator ID, Sub-Group ID> tuple corresponding to the Path message. This approach SHOULD be used when all the egresses signaled by a Path message need to be removed from the P2MP LSP. Other S2L sub-LSPs, from other sub-groups signaled using other Path messages, are not affected by the PathTear.

A transit LSR that propagates the PathTear message downstream MUST ensure that it sets the <Sub-Group Originator ID, Sub-Group ID> tuple in the PathTear message to the values used in the Path message used to set up the S2L sub-LSPs being torn down. The transit LSR may need to generate multiple PathTear messages for an incoming PathTear message if it had performed transit fragmentation for the corresponding incoming Path message.

When a P2MP LSP is removed by the ingress, a PathTear message MUST be generated for each Path message used to signal the P2MP LSP.

## **8. Notify and ResvConf Messages**

### **8.1. Notify Messages**

The Notify Request object and Notify message are described in [[RFC3473](#)]. Both object and message SHALL be supported for delivery of upstream and downstream notification. Processing not detailed in this section MUST comply to [[RFC3473](#)].

#### **1. Upstream Notification**

If a transit LSR sets the Sub-Group Originator ID in the SENDER\_TEMPLATE object of a Path message to its own address and the incoming Path message carries a Notify Request object then this LSR MUST change the Notify node address in the Notify Request object to its own address in the Path message that it sends.

If this LSR subsequently receives a corresponding Notify message from a downstream LSR than it MUST:

- send a Notify message upstream toward the Notify node address that the LSR received in the Path message.
- process the sub-group fields of the SENDER\_TEMPLATE object on the received Notify message, and modify their values in the Notify message that is forwarded to match the sub-group



field values in the original Path message received from upstream.

The receiver of an (upstream) Notify message MUST identify the state referenced in this message based on the SESSION and SENDER\_TEMPLATE.

## 2. Downstream Notification

A transit LSR sets the Sub-Group Originator ID in the FILTER\_SPEC object(s) of a Resv message to the value that was received in the corresponding Path message. If the incoming Resv message carries a Notify Request object then:

- If there is at least another incoming Resv message that carries a Notify Request object and the LSR merges these Resv messages into a single Resv message that is sent upstream, the LSR MUST set the Notify node address in the Notify Request object to its Router ID.
- Else if the LSR sets the Sub-Group Originator ID in the outgoing Path message, that corresponds to the received Resv message, to its own address, the LSR MUST set the Notify node address in the Notify Request object to its Router ID.
- Else the LSR MUST propagate the Notify Request object unchanged, in the Resv message that it sends upstream.

If this LSR subsequently receives a corresponding Notify message from an upstream LSR then it MUST:

- process the sub-group fields of the FILTER\_SPEC object in the received Notify message, and modify their values in the Notify message that is forwarded to match the sub-group field values in the original Path message sent downstream by this LSR.
- send a Notify message downstream toward the Notify node address that the LSR received in the Resv message.

The receiver of a (downstream) Notify message MUST identify the state referenced in the message based on the SESSION and FILTER\_SPEC objects.

The consequence of these rules for a P2MP LSP is that an upstream Notify message generated on a branch will result in a Notify being delivered to the upstream Notify node address. The receiver of the Notify message MUST NOT assume that the Notify message applies to all downstream egresses, but MUST examine the information in the message to determine to which egresses the message applies.

Downstream Notify messages MUST be replicated at branch LSRs according to the Notify Request objects received on Resv messages. Some downstream branches might not request Notify messages, but all



that have requested Notify messages MUST receive them.

## 8.2. ResvConf Messages

ResvConf messages are described in [RFC2205]. ResvConf processing in [RFC3473] and [RFC3209] is taken directly from [RFC2205]. An egress-LSR MAY include a RESV\_CONFIRM object that contains the egress-LSR's address. The object and message SHALL be supported for the confirmation of receipt of the Resv message in P2MP TE LSPs. Processing not detailed in this section MUST comply to [RFC2205].

A transit LSR sets the Sub-Group Originator ID in the FILTER\_SPEC object(s) of a Resv message to the value, that was received in the corresponding Path message. If any of the incoming Resv messages corresponding to a single Path message carry a RESV\_CONFIRM object then the LSR MUST include a RESV\_CONFIRM object in the corresponding Resv message that it sends upstream. If the sub-group originator ID is its own address then it MUST set the receiver address in the RESV\_CONFIRM object to this address, else it MUST propagate the object unchanged.

A transit LSR sets the Sub-Group Originator ID in the FILTER\_SPEC object(s) of a Resv message to the value that was received in the corresponding Path message. If an incoming Resv message corresponding to a single Path message carries a RESV\_CONFIRM object then the LSR MUST include a RESV\_CONFIRM object in the corresponding Resv message that it sends upstream and:

- If there is at least another incoming Resv message that carries a RESV\_CONFIRM object and the LSR merges these Resv messages into a single Resv message that is sent upstream, the LSR MUST set the receiver address in the RESV\_CONFIRM object to its Router ID.
- If the LSR sets the Sub-Group Originator ID in the outgoing Path message, that corresponds to the received Resv message, to its own address, the LSR MUST set the receiver address in the RESV\_CONFIRM object to its Router ID.
- Else the LSR MUST propagate the RESV\_CONFIRM object unchanged, in the Resv message that it sends upstream.

If this LSR subsequently receives a corresponding ResvConf message from an upstream LSR than it MUST:

- process the sub-group fields of the FILTER\_SPEC object in the received ResvConf message, and modify their values in the ResvConf message that is forwarded to match the sub-group field values in the original Path message sent downstream by this LSR.



- send a ResvConf message downstream toward the receiver address that the LSR received in the RESV\_CONFIRM object in the Resv message.

The receiver of a ResvConf message MUST identify the state referenced in this message based on the SESSION and FILTER\_SPEC objects.

The consequence of these rules for a P2MP LSP is that a ResvConf message generated at the ingress will result in a ResvConf message being delivered to the branch and then to the receiver address in the original RESV\_CONFIRM object. The receiver of a ResvConf message MUST NOT assume that the ResvConf message should be sent to all downstream egresses, but MUST replicate the message according to the RESV\_CONFIRM objects received in Resv messages. Some downstream branches might not request ResvConf messages, and ResvConf messages SHOULD NOT be sent on these branches. All downstream branches that requested ResvConf messages MUST be sent such a message.

## **9. Refresh Reduction**

The refresh reduction procedures described in [[RFC2961](#)] are equally applicable to P2MP LSPs described in this document. Refresh reduction applies to individual messages and the state they install/maintain, and that continues to be the case for P2MP LSPs.

## **10. State Management**

State signaled by a P2MP Path message is identified by a local implementation using the <P2MP ID, Tunnel ID, Extended Tunnel ID> as part of the SESSION object and <Tunnel Sender Address, LSP ID, Sub-Group Originator ID, Sub-Group ID> as part of the SENDER\_TEMPLATE object.

Additional information signaled in the Path/Resv message is part of the state created by a local implementation. This includes PHOP/NHOP and SENDER\_TSPEC/FILTER\_SPEC objects.

### **10.1. Incremental State Update**

RSVP as defined in [[RFC2205](#)] and as extended by RSVP-TE [[RFC3209](#)] and GMPLS [[RFC3473](#)] uses the same basic approach to state communication and synchronization, namely full state is sent in each state advertisement message. Per [[RFC2205](#)] Path and Resv messages are idempotent. Also, [[RFC2961](#)] categorizes RSVP messages into two types: trigger and refresh messages and improves RSVP message handling and scaling of state refreshes but does not modify the full state





advertisement nature of Path and Resv messages. The full state advertisement nature of Path and Resv messages has many benefits, but also has some drawbacks. One notable drawback is when an incremental modification is being made to a previously advertised state. In this case, there is the message overhead of sending the full state and the cost of processing it. It is desirable to overcome this drawback and add/delete S2L sub-LSPs to a P2MP LSP by incrementally updating the existing state.

It is possible to use the procedures described in this document to allow S2L sub-LSPs to be incrementally added or deleted from the P2MP LSP by allowing a Path or a PathTear message to incrementally change the existing P2MP LSP Path state.

As described in [section 5.2](#), multiple Path messages can be used to signal a P2MP LSP. The Path messages are distinguished by different <Sub-Group Originator ID, Sub-Group ID> tuples in the SENDER\_TEMPLATE object. In order to perform incremental S2L sub-LSP state addition a separate Path message with a new Sub-Group ID is used to add the new S2L sub-LSPs, by the ingress-LSR. The Sub-Group Originator ID MUST be set to the TE Router ID [[RFC3477](#)] of the node that sets the Sub-Group ID.

This maintains the idempotent nature of RSVP Path messages; avoids keeping track of individual S2L sub-LSP state expiration and provides the ability to perform incremental P2MP LSP state updates.

## **[10.2. Combining Multiple Path Messages](#)**

There is a tradeoff between the number of Path messages used by the ingress to maintain the P2MP LSP and the processing imposed by full state messages when adding S2L sub-LSPs to an existing Path message. It is possible to combine S2L sub-LSPs previously advertised in different Path messages in a single Path message in order to reduce the number of Path messages needed to maintain the P2MP LSP. This can also be done by a transit node that performed fragmentation and at a later point is able to combine multiple Path messages that it generated into a single Path message. This may happen when one or more S2L sub-LSPs are pruned from the existing Path states.

The new Path message is signaled by the node that is combining multiple Path messages with all the S2L sub-LSPs that are being combined in a single Path message. This Path message MAY contain new Sub-Group ID field values. When a new Path and Resv message that is signaled for an existing S2L sub-LSP is received by a transit LSR, state including the new instance of the S2L sub-LSP is created.







```

    [ <ACCEPTABLE_LABEL_SET> ... ]
    [ <POLICY_DATA> ... ]
    <sender descriptor>
    [ <S2L sub-LSP descriptor list> ]

```

PathErr messages generation is unmodified, but nodes that set the Sub-Group Originator field and propagate a received PathErr message upstream MUST replace the Sub-Group fields received in the PathErr message with the value that was received in the Sub-Group fields of the Path message from the upstream neighbor. Note the receiver of a PathErr message is able to identify the errored outgoing Path message, and outgoing interface, based on the Sub-Group fields received in the PathErr message. The S2L sub-LSP descriptor list is defined in [section 5.1](#).

### **11.2. ResvErr Messages**

The ResvErr message will include one or more S2L\_SUB\_LSP objects. The resulting modified format for a ResvErr Message is:

```

<ResvErr Message> ::=  <Common Header> [ <INTEGRITY> ]
                        [ [ <MESSAGE_ID_ACK> |
                          <MESSAGE_ID_NACK> ] ... ]
                        [ <MESSAGE_ID> ]
                        <SESSION> <RSVP_HOP>
                        <ERROR_SPEC> [ <SCOPE> ]
                        [ <ACCEPTABLE_LABEL_SET> ... ]
                        [ <POLICY_DATA> ... ]
                        <STYLE> <flow descriptor list>

```

ResvErr messages generation is unmodified, but nodes that set the Sub-Group Originator field and propagate a received ResvErr message downstream MUST replace the Sub-Group fields received in the ResvErr message with the value that was set in the Sub-Group fields of the Path message sent to the downstream neighbor. Note the receiver of a ResvErr message is able to identify the errored outgoing Resv message, and outgoing interface, based on the Sub-Group fields received in the ResvErr message. The flow descriptor list is defined in [section 6.1](#).



### **11.3. Branch Failure Handling**

During setup and during normal operation, PathErr messages may be received at a branch node. In all cases, a received PathErr message is first processed per standard processing rules. That is: the PathErr message is sent hop-by-hop to the ingress/branch LSR for that Path message. Intermediate nodes until this ingress/branch LSR MAY inspect this message but take no action upon it. The behavior of a branch LSR that generates a PathErr message is under the control of the ingress-LSR.

The default behavior is that the PathErr message does not have the Path\_State\_Removed flag set. However, if the ingress-LSR has set the LSP integrity flag on the Path message (see LSP\_REQUIRED\_ATTRIBUTES object in [section 5.2.4](#)) and if the Path\_State\_Removed flag is supported, the LSR generating a PathErr to report the failure of a branch of the P2MP LSP SHOULD set the Path\_State\_Removed flag.

A branch LSR that receives a PathErr message during LSP setup with the Path\_State\_Removed flag set MUST act according to the wishes of the ingress-LSR. The default behavior is that the branch LSR clears the Path\_State\_Removed flag on the PathErr and sends it further upstream. It does not tear any other branches of the LSP. However, if the LSP integrity flag is set on the Path message, the branch LSR MUST send PathTear on all other downstream branches and send the PathErr message upstream with the Path\_State\_Removed flag set.

A branch LSR that receives a PathErr message with the Path\_State\_Removed flag clear MUST act according to the wishes of the ingress-LSR. The default behavior is that the branch LSR forwards the PathErr upstream and takes no further action. However, if the LSP integrity flag is set on the Path message, the branch LSR MUST send PathTear on all downstream branches and send the PathErr upstream with the Path\_State\_Removed flag set (per [[RFC3473](#)]).

In all cases, the PathErr message forwarded by a branch LSR MUST contain the S2L sub-LSP identification and explicit routes of all branches that are reported by received PathErr messages and all branches that are explicitly torn by the branch LSR.





## **12. Admin Status Change**

A branch node that receives an ADMIN\_STATUS object processes it normally and also relays the ADMIN\_STATUS object in a Path on every branch. All Path messages may be concurrently sent to the downstream neighbors.

Downstream nodes process the change in the ADMIN\_STATUS object per [[RFC3473](#)], including generation of Resv messages. When the last received upstream ADMIN\_STATUS object had the R bit set, branch nodes wait for a Resv message with a matching ADMIN\_STATUS object to be received (or a corresponding PathErr or ResvTear message) on all branches before relaying a corresponding Resv message upstream.

## **13. Label Allocation on LANs with Multiple Downstream Nodes**

A branch LSR of a P2MP LSP on an Ethernet LAN segment SHOULD send one copy of the data traffic per downstream LSR connected on that LAN for that P2MP LSP. Procedures for preventing MPLS labelled traffic replication in such a case is beyond the scope of this document.

## **14. P2MP LSP and Sub-LSP Re-optimization**

It is possible to change the path used by P2MP LSPs to reach the destinations of the P2MP Tunnel. There are two methods that can be used to accomplish this. The first is make-before-break, defined in [[RFC3209](#)], and the second uses the sub-groups defined above.

### **14.1. Make-before-break**

In this case all the S2L sub-LSPs are signaled with a different LSP ID by the ingress-LSR and follow make-before-break procedure defined in [[RFC3209](#)]. Thus a new P2MP LSP is established. Each S2L sub-LSP is signaled with a different LSP ID, corresponding to the new P2MP LSP. After moving traffic to the new P2MP LSP, the ingress can tear down the old P2MP LSP. This procedure can be used to re-optimize the path of the entire P2MP LSP or paths to a subset of the destinations of the P2MP LSP. When modifying just a portion of the P2MP LSP this approach requires the entire P2MP LSP to be resignaled.



## **14.2. Sub-Group Based Re-optimization**

Any node may initiate re-optimization of a set of S2L sub-LSPs by using incremental state update and then, optionally, combining multiple path messages.

To alter the path taken by a particular set of S2L sub-LSPs the node initiating the path change initiates one or more separate Path messages, for the same P2MP LSP, each with a new sub-Group ID. The generation of these Path messages, each with one or more S2L sub-LSPs, follows procedures in [section 5.2](#). As is the case in [Section 10.2](#), a particular egress continues to be advertised in both the old and new Path messages until a Resv message listing the egress and corresponding to the new Path message is received by the re-optimizing node. At that point the egress SHOULD be deleted from the old Path state using the procedures of [section 7](#). Sub-tree re-optimization is then completed.

Sub-Group based re-optimization may result in transient data duplication as the new Path messages for a set of S2L sub-LSPs may transit one or more nodes with the old Path state for the same set of S2L sub-LSPs.

As is always the case, a node may choose to combine multiple path messages as described in [section 10.2](#).

## **15. Fast Reroute**

[RFC4090] extensions can be used to perform fast reroute for the mechanism described in this document when applied within packet networks. GMPLS introduces other protection techniques that can be applied to packet and non-packet environments [[RECOVERY](#)], but which are not discussed further in this document. This section only applies to LSRs that support [[RFC4090](#)].

This section uses terminology defined in [[RFC4090](#)] and fast reroute procedures defined in [[RFC4090](#)] MUST be followed unless specified below. The head-end and transit LSRs MUST follow the SESSION\_ATTRIBUTE and FAST\_REROUTE object processing as specified in [[RFC4090](#)] for each Path message and S2L sub-LSP of a P2MP LSP. Each S2L sub-LSP of a P2MP LSP MUST have the same protection characteristics. The RR0 processing MUST apply to SRRO as well unless modified below.

The sections that follow describe how Fast Reroute may be applied to P2MP MPLS TE LSPs in all of the principal operational scenarios. This document does not describe the detailed processing steps for every



imaginable usage case and they may be described in future documents, as needed.

### **15.1. Facility Backup**

Facility backup can be used for link or node protection of LSRs on the path of a P2MP LSP. The downstream labels MUST be learned by the PLR as specified in [[RFC4090](#)] from the label corresponding to the S2L sub-LSP in the RESV message. SERO processing for SEROs signaled in a backup tunnel MUST follow backup tunnel ERO processing described in [[RFC4090](#)].

#### **15.1.1. Link Protection**

If link protection is desired, a bypass tunnel MUST be used to protect the link between the PLR and next-hop. Thus all S2L sub-LSPs that use the link SHOULD be protected in the event of link failure. Note that all such S2L sub-LSPs belonging to a particular instance of a P2MP tunnel SHOULD share the same outgoing label on the link between the PLR and the next-hop as per [section 5.2.1](#). This is the P2MP LSP label on the link. Label stacking is used to send data for each P2MP LSP into the bypass tunnel. The inner label is the P2MP LSP label allocated by the next-hop.

During failure, Path messages for each S2L sub-LSP that is affected, MUST be sent to the MP, by the PLR. It is RECOMMENDED that the PLR uses the sender template-specific method to identify these Path messages. Hence the PLR will set the source address in the sender template to a local PLR address.

The MP MUST use the LSP-ID to identify the corresponding S2L sub-LSPs. The MP MUST NOT use the <sub-group originator ID, sub-group ID> while identifying the corresponding S2L sub-LSPs. In order to further process an S2L sub-LSP the MP MUST determine the protected S2L sub-LSP using the LSP-id and the S2L\_SUB\_LSP object.

#### **15.1.2. Node Protection**

If node protection is desired the PLR SHOULD use one or more P2P bypass tunnels to protect the set of S2L sub-LSPs that transit the protected node. Each of these P2P bypass tunnels MUST intersect the path of the S2L sub-LSPs that they protect on an LSR that is downstream from the protected node. This constrains the set of S2L sub-LSPs being backed-up via that bypass tunnel to those S2L sub-LSPs that pass through a common downstream MP. This MP is the



destination of the bypass tunnel. When the PLR forwards incoming data for a P2MP LSP into the bypass tunnel, the outer label is the bypass tunnel label and the inner label is the label allocated by the MP to the set of S2L sub-LSPs belonging to that P2MP LSP.

After detecting failure of the protected node the PLR MUST send one or more Path messages for all protected S2L sub-LSPs to the MP of the protected S2L sub-LSP. It is RECOMMENDED that the PLR use the sender template specific method to identify these Path messages. Hence the PLR will set the source address in the sender template to a local PLR address. The MP MUST use the LSP-ID to identify the corresponding S2L sub-LSPs. The MP MUST NOT use the <sub-group originator ID, sub-group ID> while identifying the corresponding S2L sub-LSPs because the sub-group originator ID might be changed by some LSR that is bypassed by the bypass tunnel. In order to further process an S2L sub-LSP the MP MUST determine the protected S2L sub-LSP using the LSP-ID and the S2L\_SUB\_LSP object.

Note that node protection MAY require the PLR to be branch capable in the data plane as multiple bypass tunnels may be required to backup the set of S2L sub-LSPs passing through the protected node. If the PLR is not branch capable, the node protection mechanism described here is applicable to only those cases where all the S2L sub-LSPs passing through the protected node also pass through a single MP that is downstream from the protected node. A PLR MUST set the Node protection flag in the RR0/SRR0 as specified in [[RFC4090](#)]. If a PLR is not branch capable and one or more S2L sub-LSPs are added to a P2MP tree and these S2L sub-LSPs do not transit the existing MP downstream of the protected node, then the PLR MUST reset this flag.

It is to be noted that procedures in this section require P2P bypass tunnels. Procedures for using P2MP bypass tunnels are for further study.

## **15.2. one-to-one Backup**

one-to-one backup as described in [[RFC4090](#)] can be used to protect a particular S2L sub-LSP against link and next-hop failure. Protection may be used for one or more S2L sub-LSPs between the PLR and the next-hop. All the S2L sub-LSPs corresponding to the same instance of the P2MP tunnel, between the PLR and the next-hop SHOULD share the same P2MP LSP label as per [section 5.2.1](#). All such S2L sub-LSPs belonging to a P2MP LSP MUST be protected.

The backup S2L sub-LSPs may traverse different next-hops at the PLR. Thus the set of outgoing labels and next-hops for a P2MP LSP that was using a single next-hop and label between the PLR and next-hop before





protection, may change once protection is triggered. This MAY require a PLR to be branch capable in the data plane. If the PLR is not branch capable, the one-to-one backup mechanisms described here are only applicable to those cases where all the backup S2L sub-LSPs pass through the same next-hop downstream of the PLR. Procedures for one-to-one backup when a PLR is not branch capable and all the backup S2L sub-LSPs do not pass through the same downstream next-hop are for further study.

It is recommended that the path specific method be used to identify a backup S2L sub-LSP. Hence the DETOUR object SHOULD be inserted in the backup Path message. A backup S2L sub-LSP MUST be treated as belonging to a different P2MP tunnel instance than the one specified by the LSP-id. Furthermore multiple backup S2L sub-LSPs MUST be treated as part of the same P2MP tunnel instance if they have the same LSP-ID and the same DETOUR objects. Note that as specified in [section 4](#) S2L sub-LSPs between different P2MP tunnel instances use different labels.

If there is only one S2L sub-LSP in the Path message, the DETOUR object applies to that sub-LSP. If there are multiple S2L sub-LSPs in the Path message the DETOUR object applies to all the S2L sub-LSPs.

## **16. Support for LSRs that are not P2MP Capable**

It may be that some LSRs in a network are capable of processing the P2MP extensions described in this document, but do not support P2MP branching in the data plane. If such an LSR is requested to become a branch LSR by a received Path message, it MUST respond with a PathErr message carrying the Error Code "Routing Error" and Error Value "Unable to Branch".

It is also conceivable that some LSRs, in a network deploying P2MP capability, may not support the extensions described in this document. If a Path message for the establishment of a P2MP LSP reaches such an LSR it will reject it with a PathErr because it will not recognize the C-Type of the P2MP SESSION object.

LSRs that do not support the P2MP extensions in this document may be included as transit LSRs by the use of LSP-stitching [[LSP-STITCH](#)] and LSP-hierarchy [[RFC4206](#)]. Note that LSRs that are required to play any other role in the network (ingress, branch or egress) MUST support the extensions defined in this document.

The use of LSP-stitching and LSP-hierarchy [[RFC4206](#)] allows P2MP LSPs to be built in such an environment. A P2P LSP segment is signaled from the last P2MP capable hop upstream of a legacy LSR to the first



P2MP capable hop downstream of it. This assumes that intermediate legacy LSRs are transit LSRs: they cannot act as P2MP branch points. Transit LSRs along this LSP segment do not process control plane messages associated with the P2MP LSP. Furthermore, these transit LSRs also do not need to have P2MP data plane capabilities as they only need to process data belonging to the P2P LSP segment. Hence these transit LSRs do not need to support P2MP MPLS. This P2P LSP segment is stitched to the incoming P2MP LSP. After the P2P LSP segment is established the P2MP Path message is sent to the next P2MP capable LSR as a directed Path message. The next P2MP capable LSR stitches the P2P LSP segment to the outgoing P2MP LSP.

In packet networks, the S2L sub-LSPs may be nested inside the outer P2P LSP. Hence label stacking can be used to enable use of the same LSP segment for multiple P2MP LSP. Stitching and nesting considerations and procedures are described further in [[LSP-STITCH](#)] and [[RFC4206](#)].

It may be an overhead for an operator to configure the P2P LSP segments in advance, when it is desired to support legacy LSRs. It may be desirable to do this dynamically. The ingress can use IGP extensions to determine P2MP capable LSRs [[TE-NODE-CAP](#)]. It can use this information to compute S2L sub-LSP paths such that they avoid legacy non-P2MP capable LSRs. The explicit route object of an S2L sub-LSP path may contain loose hops if there are legacy LSRs along the path. The corresponding explicit route contains a list of objects up to the P2MP capable LSR that is adjacent to a legacy LSR followed by a loose object with the address of the next P2MP capable LSR. The P2MP capable LSR expands the loose hop using its TED. When doing this it determines that the loose hop expansion requires a P2P LSP to tunnel through the legacy LSR. If such a P2P LSP exists, it uses that P2P LSP. Else it establishes the P2P LSP. The P2MP Path message is sent to the next P2MP capable LSR using non-adjacent signaling.

The P2MP capable LSR that initiates the non-adjacent signaling message to the next P2MP capable LSR may have to employ a fast detection mechanism such as [[BFD](#)] [[BFD-MPLS](#)] to the next P2MP capable LSR. This may be needed for the directed Path message Head-End to use node protection FRR when the protected node is the directed Path message tail.

Note that legacy LSRs along a P2P LSP segment cannot perform node protection of the tail of the P2P LSP segment.



## **17. Reduction in Control Plane Processing with LSP Hierarchy**

It is possible to take advantage of LSP hierarchy [[RFC4206](#)] while setting up P2MP LSP, as described in the previous section, to reduce control plane processing along transit LSRs that are P2MP capable. This is applicable only in environments where LSP hierarchy can be used. Transit LSRs along a P2P LSP segment, being used by a P2MP LSP, do not process control plane messages associated with the P2MP LSP. In fact they are not aware of these messages as they are tunneled over the P2P LSP segment. This reduces the amount of control plane processing required on these transit LSRs.

Note that the P2P LSPs can be set up dynamically as described in the previous section or preconfigured. For example in Figure 2 in [section 24](#), PE1 can setup a P2P LSP to P1 and use that as a LSP segment. The Path messages for PE3 and PE4 can now be tunneled over the LSP segment. Thus P3 is not aware of the P2MP LSP and does not process the P2MP control messages.

## **18. P2MP LSP Remerging and Cross-Over**

This section details the procedures for detecting and dealing with re-merge and cross-over. The term re-merge refers to the case of an ingress or transit node that creates a branch of a P2MP LSP, a re-merge branch, which intersects the P2MP LSP at another node farther down the tree. This may occur due to such events as an error in path calculation, an error in manual configuration, or network topology changes during the establishment of the P2MP LSP. If the procedures detailed in this section are not followed, data duplication will result.

The term cross-over refers to the case of an ingress or transit node that creates a branch of a P2MP LSP, a cross-over branch, which intersects the P2MP LSP at another node farther down the tree. It is unlike re-merge in that at the intersecting node the cross-over branch has a different outgoing interface as well as a different incoming interface. This may be necessary in certain combinations of topology and technology; e.g., in a transparent optical network in which different wavelengths are required to reach different leaf nodes.

Normally, a P2MP LSP has a single incoming interface on which all of the data for the P2MP LSP is received. The incoming interface is identified by the IF\_ID RSVP\_HOP Object, if present, and by interface over which the Path message was received if the IF\_ID RSVP\_HOP Object is not present. However, in the case of dynamic LSP re-routing, the incoming interface may change.



Similarly, in both the re-merge case and cross-over cases, a node will receive a Path message for a given P2MP LSP identifying a different incoming interface for the data, and the node needs to be able to distinguish between dynamic LSP re-routing and the re-merge/cross-over cases.

Make-before-break represents yet another similar but different case, in that the incoming interface associated with the make-before-break P2MP LSP may be different than that associated with the original P2MP LSP. However, the two P2MP LSPs will be treated as distinct, but related, LSPs because they will have different LSP ID field values in their SENDER\_TEMPLATE objects.

### **18.1. Procedures**

When a node receives a Path message, it MUST check whether it has matching state for the P2MP LSP. Matching state is identified by comparing the SESSION and SENDER\_TEMPLATE objects in the received Path message with the SESSION and SENDER\_TEMPLATE objects of each locally maintained P2MP LSP Path state. The P2MP ID, Tunnel ID, and Extended Tunnel ID in the SESSION Object and the sender address and LSP ID in the SENDER\_TEMPLATE object are used for the comparison. If the node has matching state and the incoming interface for the received Path message is different than the incoming interface of the matching P2MP LSP Path state, then the node MUST determine whether it is dealing with dynamic LSP rerouting or re-merge/cross-over.

Dynamic LSP rerouting is identified by checking whether there is any intersection between the set of S2L\_SUB\_LSP objects associated with the matching P2MP LSP Path state and the set of S2L\_SUB\_LSP objects in the received Path message. If there is any intersection, then dynamic re-routing has occurred. If there is no intersection between the two sets of S2L\_SUB\_LSP objects, then either re-merge or cross-over has occurred. (Note that in the case of dynamic LSP rerouting, Path messages for the non-intersecting members of set of S2L\_SUB\_LSPs associated with the matching P2MP LSP Path state will be received subsequently on the new incoming interface.)

In order to identify the re-merge case, the node processing the received Path message MUST identify the outgoing interfaces associated with the matching P2MP Path state. Re-merge has occurred if there is any intersection between the set of outgoing interfaces associated with the matching P2MP LSP Path state and the set of outgoing interfaces in the received Path message.





### **18.1.1. Re-Merge Procedures**

There are two approaches to dealing with the re-merge case. In the first, the node detecting the re-merge case, i.e., the re-merge node, allows the re-merge case to persist but data from all but one incoming interface is dropped at the re-merge node. In the second, the re-merge node initiates the removal of the re-merge branch(es) via signaling. Which approach is used is a matter of local policy. A node MUST support both approaches and MUST allow user configuration of which approach is to be used.

When configured to allow a re-merge case to persist, the re-merge node MUST validate consistency between the objects included in the received Path message and the matching P2MP LSP Path state. Any inconsistencies MUST result in a PathErr message sent to the previous hop of the received Path message. The Error Code is set to "Routing Problem" and the Error Value is set to "P2MP Re-Merge Parameter Mismatch".

If there are no inconsistencies, the node logically merges, from the downstream perspective, the control state of incoming Path message with the matching P2MP LSP Path state. Specifically, procedures related to processing of messages received from upstream MUST NOT be modified from the upstream perspective; this includes refresh and state timeout related processing. In addition to the standard upstream related procedures, the node MUST ensure that each object received from upstream is appropriately represented within the set of Path messages sent downstream. For example, the received <S2L sub-LSP descriptor list> MUST be included in the set of outgoing Path messages. If there are any NOTIFY\_REQUEST objects present, then the procedures defined in [Section 8](#) MUST be followed for all Path and Resv messages. Special processing is also required for Resv processing. Specifically, any Resv message received from downstream MUST be mapped into an outgoing Resv message that is sent to the previous hop of the received Path message. In practice, this translates to decomposing the complete <S2L sub-LSP descriptor list> into sub-sets that match the incoming Path messages and then constructing an outgoing Resv message for each incoming Path message.

When configured to allow a re-merge case to persist, the re-merge node receives data associated with the P2MP LSP on multiple incoming interfaces, but it MUST only send the data from one of these interfaces to its outgoing interfaces, i.e., the node MUST drop data from all but one incoming interface. This ensures that duplicate data is not sent on any outgoing interface. The mechanism used to select the incoming interface to use is implementation specific and is outside the scope of this document.



When configured to correct the re-merge branch via signaling, the re-merge node MUST send a PathErr message corresponding to the received Path message. The PathErr message MUST include all of the objects normally included in a PathErr message, as well as one or more S2L\_SUB\_LSP objects from the set of sub-LSPs associated with the matching P2MP LSP Path state. A minimum of three S2L\_SUB\_LSP objects is RECOMMENDED. This will allow the node that caused the re-merge to identify the outgoing Path state associated with the valid portion of the P2MP LSP. The set of S2L\_SUB\_LSP objects in the received Path message MUST also be included. The PathErr message MUST include the Error Code "Routing Problem" and Error Value of "P2MP Rermerge Detected". The node MAY set the Path\_State\_Removed flag [[RFC3473](#)]. As is always the case, the PathErr message is sent to the previous hop of the received Path message.

A node that receives a PathErr message that contains the Error Value "Routing Problem/P2MP Rermerge Detected" MUST determine if it is the node that created the re-merge case. This is done by checking whether there is any intersection between the set of S2L\_SUB\_LSP objects associated with the matching P2MP LSP Path state and the set of other-branch S2L\_SUB\_LSP objects in the received PathErr message. If there is, then the node created the re-merge case. Other-branch S2L\_SUB\_LSP objects are those S2L\_SUB\_LSP objects included, by the node detecting the re-merge case, in the PathErr message that were taken from the matching P2MP LSP Path state. Such S2L\_SUB\_LSP objects are identifiable as they will not be included in the Path message associated with the received PathErr message. See [Section 11.1](#) for more details on how such an association is identified.

The node SHOULD remove the re-merge case by moving the S2L\_SUB\_LSP objects included in the Path message associated with the received PathErr message to the outgoing interface associated with the matching P2MP LSP Path state. A trigger Path message for the moved S2L\_SUB\_LSP objects is then sent via that outgoing interface. If the received PathErr message did not have the Path\_State\_Removed flag set, the node SHOULD send a PathTear via the outgoing interface associated with the re-merge branch.

If use of a new outgoing interface violates one or more SERO constraint, then a PathErr message containing the associated egresses and any identified S2L\_SUB\_LSP objects SHOULD be generated with the Error Code "Routing Problem" and Error Value of "ERO Resulted in Rermerge".

The only case where this process will fail is when all the listed S2L\_SUB\_LSP objects are deleted prior to the PathErr message propagating to the ingress. In this case, the whole process will be corrected on the next (refresh or trigger) transmission of the



offending Path message.

**19. New and Updated Message Objects**

This section presents the RSVP object formats as modified by this document.

**19.1. SESSION Object**

A P2MP LSP SESSION object is used. This object uses the existing SESSION C-Num. New C-Types are defined to accommodate a logical P2MP destination identifier of the P2MP Tunnel. This SESSION object has a similar structure as the existing point to point RSVP-TE SESSION object. However the destination address is set to the P2MP ID instead of the unicast Tunnel Endpoint address. All S2L sub-LSPs that are part of the same P2MP LSP share the same SESSION object. This SESSION object identifies the P2MP Tunnel.

The combination of the SESSION object, the SENDER\_TEMPLATE object and the S2L\_SUB\_LSP object, identifies each S2L sub-LSP. This follows the existing P2P RSVP-TE notion of using the SESSION object for identifying a P2P Tunnel which in turn can contain multiple LSPs, each distinguished by a unique SENDER\_TEMPLATE object.

**19.1.1. P2MP LSP Tunnel IPv4 SESSION Object**

Class = SESSION, P2MP\_LSP\_TUNNEL\_IPv4 C-Type = 13

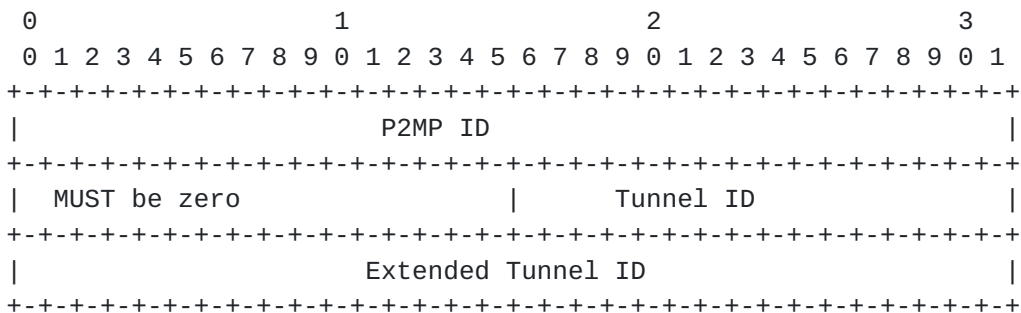

**P2MP ID**

A 32-bit identifier used in the SESSION object that remains constant over the life of the P2MP tunnel. It encodes the P2MP Identifier that is unique within the scope of the Ingress LSR.



Tunnel ID

A 16-bit identifier used in the SESSION object that remains constant over the life of the P2MP tunnel.

Extended Tunnel ID

A 32-bit identifier used in the SESSION object that remains constant over the life of the P2MP tunnel. Ingress LSRs that wish to have a globally unique identifier for the P2MP tunnel SHOULD place their tunnel sender address here. A combination of this address, P2MP ID and Tunnel ID provides a globally unique identifier for the P2MP tunnel.

**19.1.2. P2MP LSP Tunnel IPv6 SESSION Object**

This is same as the P2MP IPv4 LSP SESSION Object with the difference that the extended tunnel ID may be set to a 16 byte identifier [RFC3209].

Class = SESSION, P2MP\_LSP\_TUNNEL\_IPv4 C-Type = 14

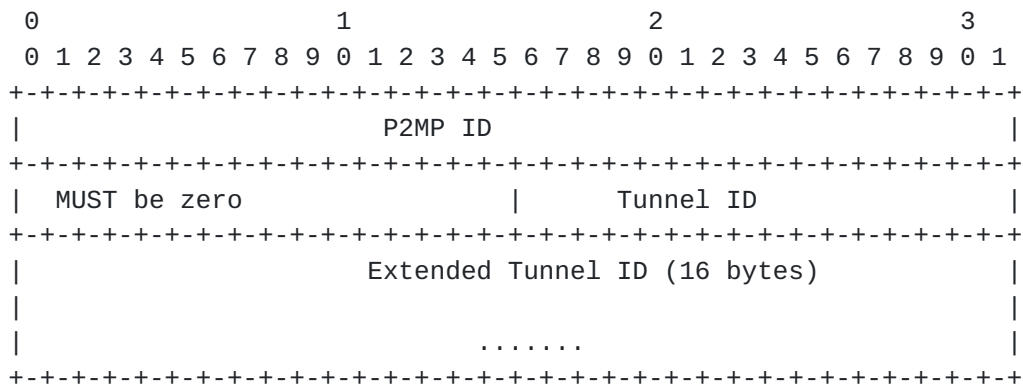

**19.2. SENDER\_TEMPLATE object**

The SENDER\_TEMPLATE object contains the ingress-LSR source address. The LSP ID can be changed to allow a sender to share resources with itself. Thus multiple instances of the P2MP tunnel can be created, each with a different LSP ID. The instances can share resources with each other. The S2L sub-LSPs corresponding to a particular instance use the same LSP ID.

As described in [section 4.2](#) it is necessary to distinguish different Path messages that are used to signal state for the same P2MP LSP by





using a <Sub-Group ID Originator ID, Sub-Group ID> tuple. The SENDER\_TEMPLATE object is modified to carry this information as shown below.

**19.2.1. P2MP LSP Tunnel IPv4 SENDER\_TEMPLATE Object**

Class = SENDER\_TEMPLATE, P2MP\_LSP\_TUNNEL\_IPv4 C-Type = 12

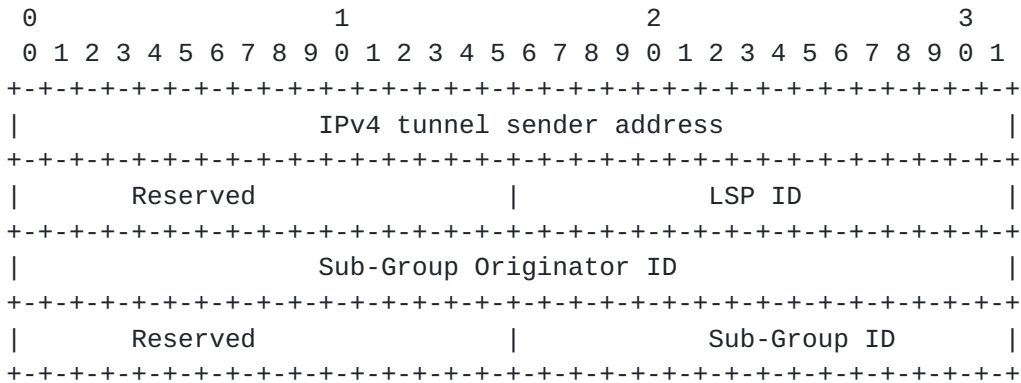

IPv4 tunnel sender address  
See [[RFC3209](#)].

Sub-Group Originator ID  
The Sub-Group Originator ID is set to the TE Router ID of the LSR that originates the Path message. This is either the ingress-LSR or an LSR which re-originates the Path message with its own Sub-Group Originator ID.

Sub-Group ID  
An identifier of a Path message used to differentiate multiple Path messages that signal state for the same P2MP LSP. This may be seen as identifying a group of one or more egress nodes targeted by this Path message.

LSP ID  
See [[RFC3209](#)]

**19.2.2. P2MP LSP Tunnel IPv6 SENDER\_TEMPLATE Object**

Class = SENDER\_TEMPLATE, P2MP\_LSP\_TUNNEL\_IPv6 C-Type = 13





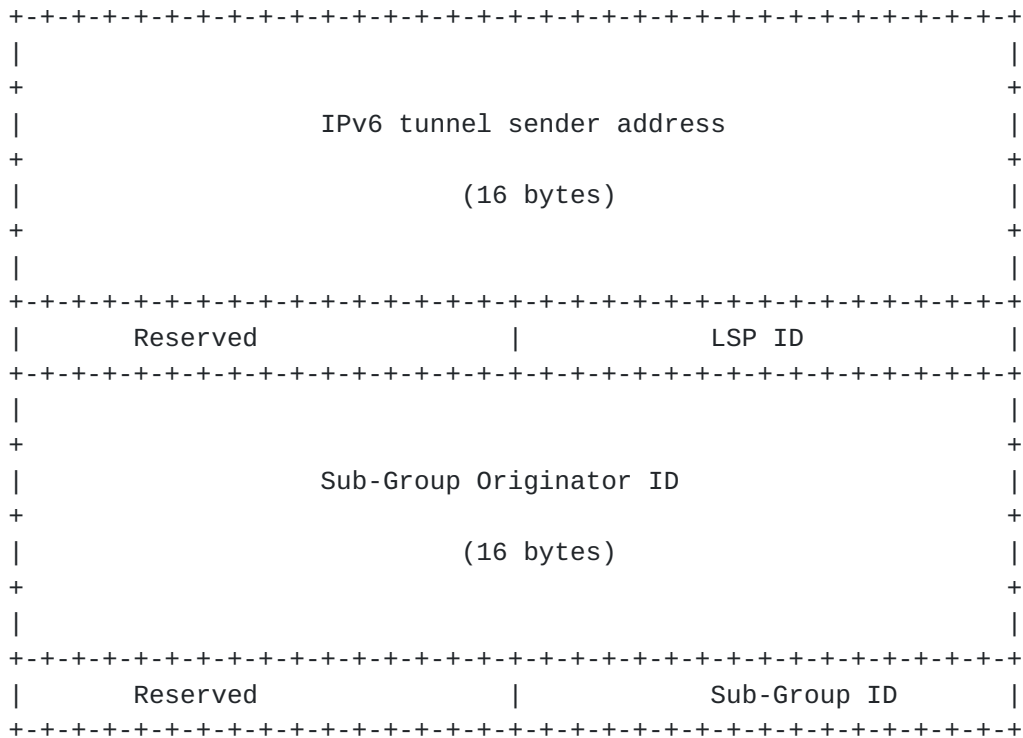

IPv6 tunnel sender address  
 See [[RFC3209](#)].

Sub-Group Originator ID  
 The Sub-Group Originator ID is set to the IPv6 TE Router ID of the LSR that originates the Path message. This is either the ingress-LSR or an LSR which re-originates the Path message with its own Sub-Group Originator ID.

Sub-Group ID  
 As above in [section 19.2.1](#).

LSP ID  
 See [[RFC3209](#)]

**19.3. S2L\_SUB\_LSP Object**

A S2L\_SUB\_LSP object identifies a particular S2L sub-LSP belonging to the P2MP LSP.



**19.3.1. S2L\_SUB\_LSP IPv4 Object**

S2L\_SUB\_LSP Class = 50, S2L\_SUB\_LSP\_IPv4 C-Type = 1

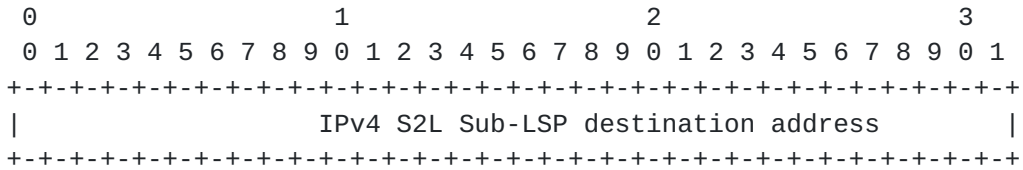

IPv4 Sub-LSP destination address

IPv4 address of the S2L sub-LSP destination.

**19.3.2. S2L\_SUB\_LSP IPv6 Object**

S2L\_SUB\_LSP Class = 50, S2L\_SUB\_LSP\_IPv6 C-Type = 2

This is same as the S2L IPv4 Sub-LSP object, with the difference that the destination address is a 16 byte IPv6 address.

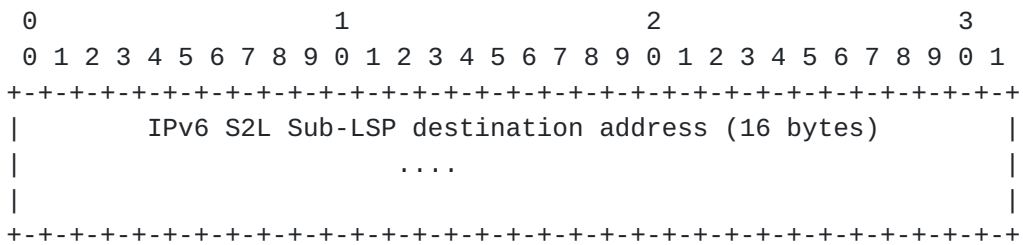

**19.4. FILTER\_SPEC Object**

The FILTER\_SPEC object is canonical to the P2MP SENDER\_TEMPLATE object.

**19.4.1. P2MP LSP\_IPv4 FILTER\_SPEC Object**

Class = FILTER SPEC, P2MP LSP\_IPv4 C-Type = 12

The format of the P2MP LSP\_IPv4 FILTER\_SPEC object is identical to the P2MP LSP\_IPv4 SENDER\_TEMPLATE object.



#### **19.4.2. P2MP LSP\_IPv6 FILTER\_SPEC Object**

Class = FILTER\_SPEC, P2MP LSP\_IPv6 C-Type = 13

The format of the P2MP LSP\_IPv6 FILTER\_SPEC object is identical to the P2MP LSP\_IPv6 SENDER\_TEMPLATE object.

#### **19.5. P2MP SECONDARY\_EXPLICIT\_ROUTE Object (SERO)**

The P2MP SECONDARY\_EXPLICIT\_ROUTE Object (SERO) is defined as identical to the ERO. The class of the P2MP SERO is the same as the SERO defined in [[RECOVERY](#)]. The P2MP SERO uses a new C-Type = 2. The sub-objects are identical to those defined for the ERO.

#### **19.6. P2MP SECONDARY\_RECORD\_ROUTE Object (SRRO)**

The P2MP SECONDARY\_RECORD\_ROUTE Object (SRRO) is defined as identical to the ERO. The class of the P2MP SRRO is the same as the SRRO defined in [[RECOVERY](#)]. The P2MP SRRO uses a new C-Type = 2. The sub-objects are identical to those defined for the RRO.

### **20. IANA Considerations**

#### **20.1. New Class Numbers**

IANA is requested to assign the following Class Numbers for the new object classes introduced. The Class Types for each of them are to be assigned via standards action. The sub-object types for the P2MP SECONDARY\_EXPLICIT\_ROUTE and P2MP\_SECONDARY\_RECORD\_ROUTE follow the same IANA considerations as those of the ERO and RRO [[RFC3209](#)].

50 Class Name = SUB\_LSP

C-Type

- 1 S2L\_SUB\_LSP\_IPv4 C-Type
- 2 S2L\_SUB\_LSP\_IPv6 C-Type





## **20.2. New Class Types**

IANA is requested to assign the following C-Type values:

Class Name = SESSION

C-Type

13 P2MP\_LSP\_IPv4 C-Type

14 P2MP\_LSP\_IPv6 C-Type

Class Name = SENDER\_TEMPLATE

C-Type

12 P2MP\_LSP\_IPv4 C-Type

13 P2MP\_LSP\_IPv6 C-Type

Class Name = FILTER\_SPEC

C-Type

12 P2MP LSP\_IPv4 C-Type

13 P2MP LSP\_IPv6 C-Type

Class Name = SECONDARY\_EXPLICIT\_ROUTE (Defined in [[RECOVERY](#)])

C-Type

2 P2MP SECONDARY\_EXPLICIT\_ROUTE C-Type

Class Name = SECONDARY\_RECORD\_ROUTE (Defined in [[RECOVERY](#)])

C-Type

2 P2MP\_SECONDARY\_RECORD\_ROUTE C-Type

## **20.3. New Error Values**

Four new Error Values are defined for use with the Error Code "Routing Problem". IANA is requested to assign values.

The Error Value "Unable to Branch" indicates that a P2MP branch cannot be formed by the reporting LSR. IANA is requested to assign value 23 to this Error Value.

The Error Value "Unsupported LSP Integrity" indicates that a P2MP branch does not support the requested LSP integrity function. IANA is requested to assign value 24 to this Error Value.

The Error Value "P2MP Reremerge Detected" indicates that a node has detected reremerge. IANA is requested to assign value 25 to this Error



Value.

The Error Value "P2MP Re-Merge Parameter Mismatch" is described in [section 18](#). IANA is requested to assign value 26 to this Error Value.

The Error Value "ERO Resulted in Remerge" is described in [section 18](#). IANA is requested to assign value 27 to this Error Value.

#### **[20.4. LSP Attributes Flags](#)**

IANA has been asked to manage the space of flags in the Attributes Flags TLV carried in the LSP\_REQUIRED\_ATTRIBUTES Object [[RFC4420](#)]. This document defines a new flag as follows:

Suggested Bit Number:	3
Meaning:	LSP Integrity Required
Used in Attributes Flags on Path:	Yes
Used in Attributes Flags on Resv:	No
Used in Attributes Flags on RR0:	No
Referenced Section of this Doc:	5.2.4

#### **[21. Security Considerations](#)**

In principle this document does not introduce any new security issues above those identified in [[RFC3209](#)], [[RFC3473](#)] and [[RFC4206](#)]. [[RFC2205](#)] specifies the message integrity mechanisms for hop-by-hop RSVP signaling. These mechanisms apply to the hop-by-hop P2MP RSVP-TE signaling in this document. Further [[RFC3473](#)] and [[RFC4206](#)] specify the security mechanisms for non hop-by-hop RSVP-TE signaling. These mechanisms apply to the non hop-by-hop P2MP RSVP-TE signaling specified in this document, particularly in sections [16](#) and [17](#).

An administration may wish to limit the domain over which P2MP TE tunnels can be established. This can be accomplished by setting filters on various ports to deny action on a RSVP path message with a SESSION object of type P2MP\_LSP\_IPv4 or P2MP\_LSP\_IPv6.

The ingress LSR of a P2MP TE LSP, determines the leaves of the P2MP TE LSP based on the application of the P2MP TE LSP. The specification of how such applications will use a P2MP TE LSP is outside the scope of this document. Applications MUST provide a mechanism to notify the ingress LSR of the appropriate leaves for the P2MP LSP. Specifications of applications within the IETF MUST specify this mechanism in sufficient detail that an ingress LSR from one vendor



can be used with an application implementation provided by another vendor. Manual configuration of security parameters when other parameters are auto-discovered is generally not sufficient to meet security and interoperability requirements of IETF specifications.

## **22. Acknowledgements**

This document is the product of many people. The contributors are listed in [Section 27.2](#).

Thanks to Yakov Rekhter, Der-Hwa Gan, Arthi Ayyanger and Nischal Sheth for their suggestions and comments. Thanks also to Dino Farninacci and Benjamin Niven for their comments.

## **23. References**

### **23.1. Normative References**

- [RFC4206] K. Kompella, Y. Rekhter, "LSP Hierarchy with Generalized MPLS TE" [[RFC4206](#)]
- [RFC4420] A. Farrel, et al. , "Encoding of Attributes for Multiprotocol Label Switching (MPLS) Label Switched Path (LSP) Establishment Using RSVP-TE", [RFC 4420](#), February 2006.
- [RFC3209] D. Awduche, L. Berger, D. Gan, T. Li, V. Srinivasan, G. Swallow, "RSVP-TE: Extensions to RSVP for LSP Tunnels", [RFC3209](#), December 2001, work in progress.
- [RFC2119] Bradner, S., "Key words for use in RFCs to Indicate Requirement Levels", [BCP 14](#), [RFC 2119](#), March 1997, work in progress.
- [RFC2205] Braden, R., Zhang, L., Berson, S., Herzog, S. and S. Jamin, "Resource ReSerVation Protocol (RSVP) -- Version 1, Functional Specification", [RFC 2205](#), September 1997, work in progress.
- [RFC3471] Lou Berger, et al., "Generalized MPLS - Signaling Functional Description", [RFC 3471](#), January 2003, work in progress.
- [RFC3473] L. Berger et al., "Generalized MPLS Signaling - RSVP-TE Extensions", [RFC 3473](#), January 2003, work in progress.



- [RFC2961] L. Berger, D. Gan, G. Swallow, P. Pan, F. Tommasi, S. Molendini, "RSVP Refresh Overhead Reduction Extensions", [RFC 2961](#), April 2001, work in progress.
- [RFC3031] Rosen, E., Viswanathan, A. and R. Callon, "Multiprotocol Label Switching Architecture", [RFC 3031](#), January 2001, work in progress.
- [RFC4090] P. Pan, G. Swallow, A. Atlas (Editors), "Fast Reroute Extensions to RSVP-TE for LSP Tunnels", work in progress.
- [RFC3477] K. Kompella, Y. Rekther, "Signalling Unnumbered Links in Resource ReSerVation Protocol - Traffic Engineering (RSVP-TE)", work in progress.
- [RECOVERY] "GMPLS Based Segment Recovery", [draft-ietf-ccamp-gmpls-segment-recovery-03.txt](#)

### **[23.2. Informative References](#)**

- [RFC4461] S. Yasukawa, Editor "Signaling Requirements for Point-to-Multipoint Traffic Engineered MPLS LSPs", [RFC4461](#).
- [BFD] D. Katz, D. Ward, "Bidirectional Forwarding Detection", [draft-ietf-bfd-base-05.txt](#), work in progress.
- [BFD-MPLS] R. Aggarwal, K. Kompella, T. Nadeau, G. Swallow, "BFD for MPLS LSPs", [draft-ietf-bfd-mpls-02.txt](#), work in progress.
- [LSP-STITCH] A. Ayyanger, J.P. Vasseur, "Label Switched Path Stitching with Generalized MPLS Traffic Engineering", [draft-ietf-ccamp-lsp-stitching-03.txt](#), March 2006 work in progress
- [TE-NODE-CAP] JP Vasseur, JL Le Roux, et al. "Routing extensions for discovery of Traffic Engineering Node Capabilities", [draft-ietf-ccamp-te-node-cap-01.txt](#), June 2006, work in progress
- [RFC4003] L. Berger, "GMPLS Signaling Procedure for Egress Control", February, 2005.





**24. Appendix**

**24.1. Example**

Following is one example of setting up a P2MP LSP using the procedures described in this document.

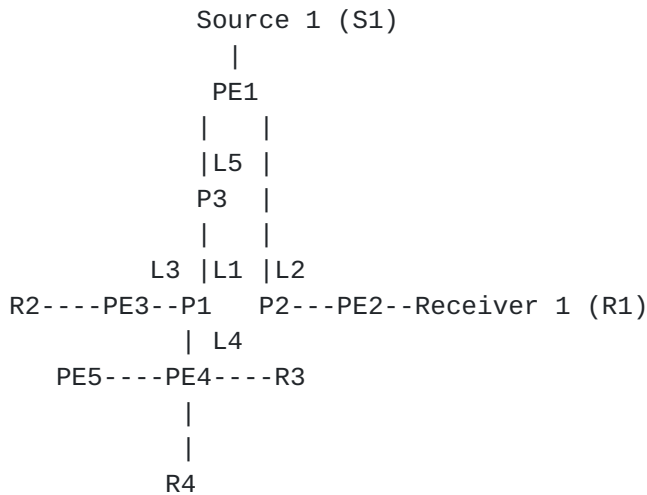

Figure 2.

The mechanism is explained using Figure 2. PE1 is the ingress-LSR. PE2, PE3 and PE4 are Egress-LSRs.

- a) PE1 learns that PE2, PE3 and PE4 are interested in joining a P2MP tree with a P2MP ID of P2MP ID1. We assume that PE1 learns of the egress-LSRs at different points in time.
- b) PE1 computes the P2P path to reach PE2.
- c) PE1 establishes the S2L sub-LSP to PE2 along <PE1, P2, PE2>
- d) PE1 computes the P2P path to reach PE3 when it discovers PE3. This path is computed to share the same links where possible with the sub-LSP to PE2 as they belong to the same P2MP session.
- e) PE1 establishes the S2L sub-LSP to PE3 along <PE1, P3, P1, PE3>
- f) PE1 computes the P2P path to reach PE4 when it discovers PE4. This path is computed to share the same links where possible with the sub-LSPs to PE2 and PE3 as they belong to the same P2MP session.
- g) PE1 signals the Path message for PE4 sub-LSP along <PE1, P3, P1,



PE4>

e) P1 receives a Resv message from PE4 with label L4. It had previously received a Resv message from PE3 with label L3. It had allocated a label L1 for the sub-LSP to PE3. It uses the same label and sends the Resv messages to P3. Note that it may send only one Resv message with multiple flow descriptors in the flow descriptor list. If this is the case and FF style is used, the FF flow descriptor will contain the S2L sub-LSP descriptor list with two entries: one for PE4 and the other for PE3. For SE style, the SE filter spec will contain this S2L sub-LSP descriptor list. P1 also creates a label mapping of (L1 -> {L3, L4}). P3 uses the existing label L5 and sends the Resv message to PE1, with label L5. It reuses the label mapping of {L5 -> L1}.

## **[25. Author Information](#)**

### **[25.1. Editor Information](#)**

Rahul Aggarwal  
Juniper Networks  
1194 North Mathilda Ave.  
Sunnyvale, CA 94089  
Email: rahul@juniper.net

Seisho Yasukawa  
NTT Corporation  
9-11, Midori-Cho 3-Chome  
Musashino-Shi, Tokyo 180-8585 Japan  
Phone: +81 422 59 4769  
EMail: yasukawa.seisho@lab.ntt.co.jp

Dimitri Papadimitriou  
Alcatel  
Francis Wellesplein 1,  
B-2018 Antwerpen, Belgium  
Phone: +32 3 240-8491  
Email: Dimitri.Papadimitriou@alcatel.be



## **25.2. Contributor Information**

John Drake  
Boeing  
Email: john.E.Drake2@boeing.com

Alan Kullberg  
Motorola Computer Group  
120 Turnpike Road 1st Floor  
Southborough, MA 01772  
EMail: alan.kullberg@motorola.com

Lou Berger  
LabN Consulting, L.L.C.  
EMail: lberger@labn.net

Liming Wei  
Redback Networks  
350 Holger Way  
San Jose, CA 95134  
Email: lwei@redback.com

George Apostolopoulos  
Redback Networks  
350 Holger Way  
San Jose, CA 95134  
Email: georgeap@redback.com

Kireeti Kompella  
Juniper Networks  
1194 N. Mathilda Ave  
Sunnyvale, CA 94089  
Email: kireeti@juniper.net

George Swallow  
Cisco Systems, Inc.  
300 Beaver Brook Road  
Boxborough , MA - 01719  
USA  
Email: swallow@cisco.com

JP Vasseur  
Cisco Systems, Inc.  
300 Beaver Brook Road  
Boxborough , MA - 01719  
USA  
Email: jpv@cisco.com



Dean Cheng  
Cisco Systems Inc.  
170 W Tasman Dr.  
San Jose, CA 95134  
Phone 408 527 0677  
Email: [dcheng@cisco.com](mailto:dcheng@cisco.com)

Markus Jork  
Avici Systems  
101 Billerica Avenue  
N. Billerica, MA 01862  
Phone: +1 978 964 2142  
EMail: [mjork@avici.com](mailto:mjork@avici.com)

Hisashi Kojima  
NTT Corporation  
9-11, Midori-Cho 3-Chome  
Musashino-Shi, Tokyo 180-8585 Japan  
Phone: +81 422 59 6070  
EMail: [kojima.hisashi@lab.ntt.co.jp](mailto:kojima.hisashi@lab.ntt.co.jp)

Andrew G. Malis  
Tellabs  
2730 Orchard Parkway  
San Jose, CA 95134  
Phone: +1 408 383 7223  
Email: [Andy.Malis@tellabs.com](mailto:Andy.Malis@tellabs.com)

Koji Sugisono  
NTT Corporation  
9-11, Midori-Cho 3-Chome  
Musashino-Shi, Tokyo 180-8585 Japan  
Phone: +81 422 59 2605  
EMail: [sugisono.koji@lab.ntt.co.jp](mailto:sugisono.koji@lab.ntt.co.jp)

Masanori Uga  
NTT Corporation  
9-11, Midori-Cho 3-Chome  
Musashino-Shi, Tokyo 180-8585 Japan  
Phone: +81 422 59 4804  
EMail: [uga.masanori@lab.ntt.co.jp](mailto:uga.masanori@lab.ntt.co.jp)

Igor Bryskin  
Movaz Networks, Inc.  
7926 Jones Branch Drive  
Suite 615  
McLean VA, 22102  
[ibryskin@movaz.com](mailto:ibryskin@movaz.com)





Adrian Farrel  
Old Dog Consulting  
Phone: +44 0 1978 860944  
EMail: [adrian@olddog.co.uk](mailto:adrian@olddog.co.uk)

Jean-Louis Le Roux  
France Telecom  
2, avenue Pierre-Marzin  
22307 Lannion Cedex  
France  
E-mail: [jeanlouis.leroux@francetelecom.com](mailto:jeanlouis.leroux@francetelecom.com)

## **26. Intellectual Property**

The IETF takes no position regarding the validity or scope of any Intellectual Property Rights or other rights that might be claimed to pertain to the implementation or use of the technology described in this document or the extent to which any license under such rights might or might not be available; nor does it represent that it has made any independent effort to identify any such rights. Information on the procedures with respect to rights in RFC documents can be found in [BCP 78](#) and [BCP 79](#).

Copies of IPR disclosures made to the IETF Secretariat and any assurances of licenses to be made available, or the result of an attempt made to obtain a general license or permission for the use of such proprietary rights by implementers or users of this specification can be obtained from the IETF on-line IPR repository at <http://www.ietf.org/ipr>.

The IETF invites any interested party to bring to its attention any copyrights, patents or patent applications, or other proprietary rights that may cover technology that may be required to implement this standard. Please address the information to the IETF at [ietf-ipr@ietf.org](mailto:ietf-ipr@ietf.org).

## **27. Full Copyright Statement**

Copyright (C) The Internet Society (2007). This document is subject to the rights, licenses and restrictions contained in [BCP 78](#), and except as set forth therein, the authors retain all their rights.

This document and the information contained herein are provided on an "AS IS" basis and THE CONTRIBUTOR, THE ORGANIZATION HE/SHE REPRESENTS



OR IS SPONSORED BY (IF ANY), THE INTERNET SOCIETY AND THE INTERNET ENGINEERING TASK FORCE DISCLAIM ALL WARRANTIES, EXPRESS OR IMPLIED, INCLUDING BUT NOT LIMITED TO ANY WARRANTY THAT THE USE OF THE INFORMATION HEREIN WILL NOT INFRINGE ANY RIGHTS OR ANY IMPLIED WARRANTIES OF MERCHANTABILITY OR FITNESS FOR A PARTICULAR PURPOSE.

## **28. Acknowledgement**

Funding for the RFC Editor function is currently provided by the Internet Society.