

Workgroup: RAW

Published: 30 November 2022

Intended Status: Informational

Expires: 3 June 2023

Authors: P. Thubert, Ed. D. Cavalcanti

Cisco Systems Intel

X. Vilajosana

Universitat Oberta de Catalunya

C. Schmitt

J. Farkas

Research Institute CODE, UniBw M Ericsson

Reliable and Available Wireless Technologies

Abstract

This document presents a series of recent technologies that are capable of time synchronization and scheduling of transmission, making them suitable to carry time-sensitive flows with high reliability and availability.

Status of This Memo

This Internet-Draft is submitted in full conformance with the provisions of BCP 78 and BCP 79.

Internet-Drafts are working documents of the Internet Engineering Task Force (IETF). Note that other groups may also distribute working documents as Internet-Drafts. The list of current Internet-Drafts is at <https://datatracker.ietf.org/drafts/current/>.

Internet-Drafts are draft documents valid for a maximum of six months and may be updated, replaced, or obsoleted by other documents at any time. It is inappropriate to use Internet-Drafts as reference material or to cite them other than as "work in progress."

This Internet-Draft will expire on 3 June 2023.

Copyright Notice

Copyright (c) 2022 IETF Trust and the persons identified as the document authors. All rights reserved.

This document is subject to BCP 78 and the IETF Trust's Legal Provisions Relating to IETF Documents (<https://trustee.ietf.org/license-info>) in effect on the date of publication of this document. Please review these documents carefully, as they describe your rights and restrictions with respect to this document. Code Components extracted from this document must include Revised BSD License text as described in

Section 4.e of the Trust Legal Provisions and are provided without warranty as described in the Revised BSD License.

Table of Contents

1. [Introduction](#)
2. [Terminology](#)
3. [Towards Reliable and Available Networks](#)
 - 3.1. [Scheduling for Reliability](#)
 - 3.2. [Diversity for Availability](#)
 - 3.3. [Benefits of Scheduling](#)
4. [IEEE 802.11](#)
 - 4.1. [Provenance and Documents](#)
 - 4.2. [802.11ax High Efficiency \(HE\)](#)
 - 4.2.1. [General Characteristics](#)
 - 4.2.2. [Applicability to deterministic flows](#)
 - 4.3. [802.11be Extreme High Throughput \(EHT\)](#)
 - 4.3.1. [General Characteristics](#)
 - 4.3.2. [Applicability to deterministic flows](#)
 - 4.4. [802.11ad and 802.11ay \(mmWave operation\)](#)
 - 4.4.1. [General Characteristics](#)
 - 4.4.2. [Applicability to deterministic flows](#)
5. [IEEE 802.15.4](#)
 - 5.1. [Provenance and Documents](#)
 - 5.2. [TimeSlotted Channel Hopping](#)
 - 5.2.1. [General Characteristics](#)
 - 5.2.2. [Applicability to Deterministic Flows](#)
6. [5G](#)
 - 6.1. [Provenance and Documents](#)
 - 6.2. [General Characteristics](#)
 - 6.3. [Deployment and Spectrum](#)
 - 6.4. [Applicability to Deterministic Flows](#)
 - 6.4.1. [System Architecture](#)
 - 6.4.2. [Overview of The Radio Protocol Stack](#)
 - 6.4.3. [Radio \(PHY\)](#)
 - 6.4.4. [Scheduling and QoS \(MAC\)](#)
 - 6.4.5. [Time-Sensitive Communications \(TSC\)](#)
 - 6.5. [Summary](#)
7. [L-band Digital Aeronautical Communications System](#)
 - 7.1. [Provenance and Documents](#)
 - 7.2. [General Characteristics](#)
 - 7.3. [Deployment and Spectrum](#)
 - 7.4. [Applicability to Deterministic Flows](#)
 - 7.4.1. [System Architecture](#)
 - 7.4.2. [Overview of The Radio Protocol Stack](#)
 - 7.4.3. [Radio \(PHY\)](#)
 - 7.4.4. [Scheduling, Frame Structure and QoS \(MAC\)](#)
 - 7.5. [Summary](#)
8. [IANA Considerations](#)

- [9. Security Considerations](#)
- [10. Contributors](#)
- [11. Acknowledgments](#)
- [12. Normative References](#)
- [13. Informative References](#)
- [Authors' Addresses](#)

1. Introduction

When used in math or philosophy, the term "deterministic" generally refers to a perfection where all aspects are understood and predictable. A perfectly deterministic network would ensure that every packet reach its destination following a predetermined path along a predefined schedule to be delivered at the exact due time. In a real and imperfect world, a deterministic network must be highly predictable, which is a combination of reliability and availability.

*On the one hand the network must be reliable, meaning that it will perform as expected for all but very few packets and in particular that it will deliver the packets at the destination within a pre-defined time interval. .

*On the other hand, the network must be available, meaning that it has to be resilient to any single outage, independently of the cause of the failure, be it software, hardware, or an external, e.g., a physical event impacting the transmission channel.

RAW (Reliable and Available Wireless) is an effort to provide Deterministic Networking [[RFC8557](#)] in networking environments where at least some segments of a path are wireless. Making Wireless Reliable and Available is even more challenging than it is with wires, due to the numerous causes of loss in transmission that add up to the congestion losses and the delays caused by overbooked shared resources. In order to maintain a similar quality of service along a multihop path that is composed of wired and wireless hops, additional methods that are specific to wireless must be leveraged to combat the sources of loss that are also specific to wireless.

Such wireless-specific methods include per-hop retransmissions (HARQ) and P2MP overhearing whereby multiple receivers are scheduled to receive the same transmission, which balances the adverse effects of the transmission losses that are experienced when a radio is used as pure P2P. Those methods are collectively referred to as Packet (hybrid) ARQ, Replication, Elimination and Ordering (PAREO) functions in the "[Reliable and Available Wireless Architecture/Framework](#)" [[I-D.ietf-raw-architecture](#)].

2. Terminology

The terms Reliable and Available in the context of RAW require some discussion; that discussion takes place in the RAW architecture [[I-D.ietf-raw-architecture](#)]. Summarized definitions are provided below.

This specification uses several terms that are uncommon on protocols that ensure best effort transmissions for stochastic flows, such as found in the traditional Internet and other statistically multiplexed packet networks.

ARQ: Automatic Repeat Request, enabling an acknowledged transmission and retries. ARQ is a typical model at Layer-2 on a wireless medium. It is typically avoided end-to-end on deterministic flows because it introduces excessive indetermination in latency, but a limited number of retries within a bounded time may be used over a wireless link and yet respect end-to-end constraints.

Availability: Availability is a measure of the relative amount of time where a path operates in stated condition, in other words $(\text{uptime})/(\text{uptime}+\text{downtime})$.

Available: That is exempt of unscheduled outage, the expectation for a network being that the flow is maintained in the face of any single breakage.

Deterministic Networking See section 2 of [[RFC8557](#)].

Deterministic Network See section 4.1.2 of [[RFC8655](#)].

Deterministic Flow Identifier (L2) : A tuple identified by a stream_handle, and provided by a bridge, in accordance with IEEE 802.1CB. The tuple comprises at least src MAC, dst MAC, VLAN ID, and L2 priority. Continuous streams are characterized by bandwidth and max packet size; scheduled streams are characterized by a repeating pattern of timed transmissions.

Deterministic Flow Identifier (L3): See section 3.3 of [[RFC8938](#)]. The classical IP 5-tuple that identifies a flow comprises the src IP, dst IP, src port, dest port, and the upper layer protocol (ULP). DetNet uses a 6-tuple where the extra field is the DSCP field in the packet. The IPv6 flow label is not used. for that purpose.

Uplink: Connection from end-devices to a data communication equipment. In the context of wireless, uplink refers to the connection between a station (STA) and a controller (AP) or a User Equipment (UE) to a Base Station (BS).

Downlink:

The reverse direction.

Traffic type profile (IEEE): Corresponds to the traffic classification identifier provided to a deterministic flow. Traffic classes receive an identifier numbered from 0 to 8 (N-1), where N is the number of outbound queues associated with a given Bridge port. Each traffic class has a one-to-one correspondence with a specific egress/outbound queue for a port.

FEC: Forward error correction, sending redundant coded data to help the receiver recover transmission errors without the delays incurred with ARQ.

HARQ: Hybrid ARQ, a combination of FEC and ARQ.

PCE: Path Computation Element.

PREOF : DetNet Packet Replication, Elimination and Ordering Functions.

PAREO: Packet (hybrid) ARQ, Replication, Elimination and Ordering. PAREO is a superset of DetNet's PREOF that includes radio-specific techniques such as short range broadcast, MUMIMO, constructive interference and overhearing, which can be leveraged separately or combined to increase the reliability.

Reliability: Reliability is a measure of the probability that an item will perform its intended function for a specified interval under stated conditions. For RAW, the service that is expected is delivery within a bounded latency and a failure is when the packet is either lost or delivered too late.

Track: A networking graph that can be used as a "path" to transport RAW packets with equivalent treatment; a Track may fork and rejoin to enable the PAREO operations.

3. Towards Reliable and Available Networks

3.1. Scheduling for Reliability

A packet network is reliable for critical (e.g., time-sensitive) packets when the undesirable statistical effects that affect the transmission of those packets, e.g., delay or loss, are eliminated.

The reliability of a Deterministic Network [[RFC8655](#)] often relies on precisely applying a tight schedule that controls the use of time-shared resources such as CPUs and buffers, and maintains at all time the amount of the critical packets within the physical capabilities of the hardware and that of the transmission medium. The schedule

can also be used to shape the flows by controlling the time of transmission of the packets that compose the flow at every hop.

To achieve this, there must be a shared sense of time throughout the network. The sense of time is usually provided by the lower layer and is not in scope for RAW. As an example, the Precision Time Protocol, standardized as IEEE 1588 and IEC 61588, has mapping to Ethernet but also to a number of industrial and Smartrid protocols through profiles. Wi-Fi relies on IEEE Std 802.1AS, which incorporates a PTP profile, for Fine Timing Measurement.

3.2. Diversity for Availability

Equipment failure, such as a switch or an access point rebooting, a broken wire or radio adapter, or a fixed obstacle to the transmission, can be the cause of multiple packets lost in a row before the flows are rerouted or the system may recover.

This is not acceptable for critical applications such as related to safety. A typical process control loop will tolerate an occasional packet loss, but a loss of several packets in a row will cause an emergency stop (e.g., after 4 packets lost, within a period of 1 second). In an amusement park, a continuous loss of packet for a few 100ms may trigger an automatic interruption of the ride and cause the evacuation and the reboot of the game.

Network Availability is obtained by making the transmission resilient against hardware failures and radio transmission losses due to uncontrolled events such as co-channel interferers, multipath fading or moving obstacles. The best results are typically achieved by pseudo-randomly cumulating all forms of diversity, in the spatial domain with replication and elimination, in the time domain with ARQ and diverse scheduled transmissions, and in the frequency domain with frequency hopping or channel hopping between frames.

3.3. Benefits of Scheduling

Scheduling redundant transmissions of the critical packets of diverse paths improves the resiliency against breakages and statistical transmission loss, such as due to cosmic particles on wires, and interferences on wireless.

When required, the worst case time of delivery can be guaranteed as part of the end-to-end schedule, and the sense of time that must be shared throughout the network can be exposed to and leveraged by other applications.

In addition, scheduling provides specific value over the wireless medium:

- *Scheduling allows a time-sharing operation, where every transmission is assigned its own time/frequency resource. IOW, sender and receiver are synchronized and scheduled to talk on a given frequency resource at a given time and for a given duration. This way, scheduling can avoid collisions between scheduled transmissions and enable a high ratio of critical traffic compared to QoS-based priority.
- *Scheduling can be used as a technouque for both time and frequency diversity (e.g., between retries), allowing the next transmission to happen on a different frequency as programmed in both sender and receiver. This is useful to defeat co-channel interference from un-controlled transmitters as well as multipath fading.
- *Transmissions can be also scheduled on multiple channels in parallel, which enables to use the full available spectrum while avoiding the hidden terminal problem, e.g., when the next packet in a same flow interferes on a same channel with the previous one that progressed a few hops farther.
- *On the other hand, scheduling optimizes the bandwidth usage: compared to classical Collision Avoidance techniques, there is no blank time related to inter-frame space (IFS) and exponential back-off in scheduled operations. A minimal Clear Channel Assessment may be needed to comply with the local regulations such as ETSI 300-328, but that will not detect a collision when the senders are synchronized.
- *Finally, scheduling plays a critical role to save energy. In IoT, energy is the foremost concern, and synchronizing sender and listener enables to always maintain them in deep sleep when there is no scheduled transmission. This avoids idle listening and long preambles and enables long sleep periods between traffic and resynchronization, allowing battery-operated nodes to operate in a mesh topology for multiple years.

4. IEEE 802.11

4.1. Provenance and Documents

With an active portfolio of nearly 1,300 standards and projects under development, IEEE is a leading developer of industry standards in a broad range of technologies that drive the functionality, capabilities, and interoperability of products and services, transforming how people live, work, and communicate.

The IEEE 802 LAN/MAN Standards Committee (SC) develops and maintains networking standards and recommended practices for local, metropolitan, and other area networks, using an open and accredited process, and advocates them on a global basis. The most widely used standards are for Ethernet, Bridging and Virtual Bridged LANs Wireless LAN, Wireless PAN, Wireless MAN, Wireless Coexistence, Media Independent Handover Services, and Wireless RAN. An individual Working Group provides the focus for each area. Standards produced by the IEEE 802 SC are freely available from the IEEE GET Program after they have been published in PDF for six months.

The IEEE 802.11 Wireless LAN (WLAN) standards define the underlying MAC and PHY layers for the Wi-Fi technology. Wi-Fi/802.11 is one of the most successful wireless technologies, supporting many application domains. While previous 802.11 generations, such as 802.11n and 802.11ac, have focused mainly on improving peak throughput, more recent generations are also considering other performance vectors, such as efficiency enhancements for dense environments in 802.11ax, latency, reliability and enhancements supporting Time-Sensitive Networking (TSN) [[IEEE802.1TSN](#)] capabilities in P802.11be.

IEEE Std 802.11-2012 introduced support for TSN time synchronization based on IEEE 802.1AS over 802.11 Timing Measurement protocol. IEEE Std 802.11-2016 extended the 802.1AS operation over 802.11 Fine Timing Measurement (FTM), as well as the Stream Reservation Protocol (IEEE 802.1Qat). 802.11 WLANs can also be part of a 802.1Q bridged networks with enhancements enabled by the 802.11ak amendment now retrofitted in IEEE Std 802.11-2020. Traffic classification based on 802.1Q VLAN tags is also supported in 802.11. Other 802.1 TSN capabilities such as 802.1Qbv and 802.1CB, which are media agnostic, can already operate over 802.11. The IEEE Std 802.11ax-2021 adds new scheduling capabilities that can enhance the timeliness performance in the 802.11 MAC and achieve lower bounded latency. The IEEE 802.11be is undergoing efforts to enhance the support for 802.1 TSN capabilities especially related to worst-case latency, reliability and availability. The IEEE 802.11 working group has been working in collaboration with the IEEE 802.1 working group for several years extending some 802.1 features over 802.11. As with any wireless media, 802.11 imposes new constraints and restrictions to TSN-grade QoS, and tradeoffs between latency and reliability guarantees must be considered as well as managed deployment requirements. An overview of 802.1 TSN capabilities and challenges for their extensions to 802.11 are discussed in [[Cavalcanti 2019](#)].

Wi-Fi Alliance (WFA) is the worldwide network of companies that drives global Wi-Fi adoption and evolution through thought leadership, spectrum advocacy, and industry-wide collaboration. The WFA work helps ensure that Wi-Fi devices and networks provide users

the interoperability, security, and reliability they have come to expect.

Avnu Alliance is also a global industry forum developing interoperability testing for TSN capable devices across multiple media including Ethernet, Wi-Fi, and 5G.

The following [[IEEE Std 802.11](#)] specifications/certifications are relevant in the context of reliable and available wireless services and support for time-sensitive networking capabilities:

Time Synchronization: IEEE802.11-2016 with IEEE802.1AS; WFA TimeSync Certification.

Congestion Control: IEEE Std 802.11-2016 Admission Control; WFA Admission Control.

Security: WFA Wi-Fi Protected Access, WPA2 and WPA3.

Interoperating with IEEE802.1Q bridges: IEEE Std 802.11-2020 incorporating 802.11ak.

Stream Reservation Protocol (part of [[IEEE Std 802.1Qat](#)]):
AIEEE802.11-2016

Scheduled channel access: IEEE802.11ad Enhancements for very high throughput in the 60 GHz band [[IEEE Std 802.11ad](#)].

802.11 Real-Time Applications: Topic Interest Group (TIG) ReportDoc [[IEEE doc 11-18-2009-06](#)].

In addition, major amendments being developed by the IEEE802.11 Working Group include capabilities that can be used as the basis for providing more reliable and predictable wireless connectivity and support time-sensitive applications:

IEEE 802.11ax D4.0: Enhancements for High Efficiency (HE).
[[IEEE Std 802.11ax](#)]

IEEE 802.11be Extreme High Throughput (EHT). [[IEEE 802.11be WIP](#)]

IEE 802.11ay Enhanced throughput for operation in license-exempt bands above 45 GHz.
[[IEEE Std 802.11ay](#)]

The main 802.11ax and 802.11be capabilities and their relevance to RAW are discussed in the remainder of this document.

4.2. 802.11ax High Efficiency (HE)

4.2.1. General Characteristics

The next generation Wi-Fi (Wi-Fi 6) is based on the IEEE802.11ax amendment [[IEEE Std 802.11ax](#)], which includes new capabilities to increase efficiency, control and reduce latency. Some of the new features include higher order 1024-QAM modulation, support for uplink multiple user (MU) multiple input multiple output (MIMO), orthogonal frequency-division multiple access (OFDMA), trigger-based access and Target Wake time (TWT) for enhanced power savings. The OFDMA mode and trigger-based access enable the AP, after reserving the channel using the clear channel assessment procedure for a given duration, to schedule multi-user transmissions, which is a key capability required to increase latency predictability and reliability for time-sensitive flows. 802.11ax can operate in up to 160 MHz channels and it includes support for operation in the new 6 GHz band, which is expected to be open to unlicensed use by the FCC and other regulatory agencies worldwide.

4.2.1.1. Multi-User OFDMA and Trigger-based Scheduled Access

802.11ax introduced a new OFDMA mode in which multiple users can be scheduled across the frequency domain. In this mode, the Access Point (AP) can initiate multi-user (MU) Uplink (UL) transmissions in the same PHY Protocol Data Unit (PPDU) by sending a trigger frame. This centralized scheduling capability gives the AP much more control of the channel in its Basic Service Set (BSS) and it can remove contention between associated stations for uplink transmissions, therefore reducing the randomness caused by CSMA-based access between stations within the same BSS. The AP can also transmit simultaneously to multiple users in the downlink direction by using a Downlink (DL) MU OFDMA PPDU. In order to initiate a contention free Transmission Opportunity (TXOP) using the OFDMA mode, the AP still follows the typical listen before talk procedure to acquire the medium, which ensures interoperability and compliance with unlicensed band access rules. However, 802.11ax also includes a multi-user Enhanced Distributed Channel Access (MU-EDCA) capability, which allows the AP to get higher channel access priority than other devices in its BSS.

4.2.1.2. Traffic Isolation via OFDMA Resource Management and Resource Unit Allocation

802.11ax relies on the notion of OFDMA Resource Unit (RU) to allocate frequency chunks to different STAs over time. RUs provide a way to allow for multiple stations to transmit simultaneously, starting and ending at the same time. The way this is achieved is via padding, where extra bits are transmitted with the same power

level. The current RU allocation algorithms provide a way to achieve traffic isolation per station which while per se does not support time-aware scheduling, is a key aspect to assist reliability, as it provides traffic isolation in a shared medium. IEEE 802.11be (see [Section 4.3](#)) is currently considering further and more flexible approaches concerning RU allocation.

4.2.1.3. Improved PHY Robustness

The 802.11ax PHY can operate with 0.8, 1.6 or 3.2 microsecond guard interval (GI). The larger GI options provide better protection against multipath, which is expected to be a challenge in industrial environments. The possibility to operate with smaller resource units (e.g. 2 MHz) enabled by OFDMA also helps reduce noise power and improve SNR, leading to better packet error rate (PER) performance.

802.11ax supports beamforming as in 802.11ac, but introduces UL MU MIMO, which helps improve reliability. The UL MU MIMO capability is also enabled by the trigger based access operation in 802.11ax.

4.2.1.4. Support for 6GHz band

The 802.11ax specification [[IEEE Std 802.11ax](#)] includes support for operation in the new 6 GHz band. Given the amount of new spectrum available as well as the fact that no legacy 802.11 device (prior 802.11ax) will be able to operate in this new band, 802.11ax operation in this new band can be even more efficient.

4.2.2. Applicability to deterministic flows

TSN capabilities, as defined by the IEEE 802.1 TSN standards, provide the underlying mechanism for supporting deterministic flows in a Local Area Network (LAN). The 802.11 working group has incorporated support for absolute time synchronization to extend the TSN 802.1AS protocol so that time-sensitive flow can experience precise time synchronization when operating over 802.11 links. As IEEE 802.11 and IEEE 802.1 TSN are both based on the IEEE 802 architecture, 802.11 devices can directly implement some TSN capabilities without the need for a gateway/translation protocol. Basic features required for operation in a 802.1Q LAN are already enabled for 802.11. Some TSN capabilities, such as 802.1Qbv, can already operate over the existing 802.11 MAC SAP [[Sudhakaran2021](#)]. Implementation and experimental results of TSN capabilities (802.1AS, 802.1Qbv, and 802.1CB) extended over standard Ethernet and Wi-Fi devices have also been described in [[Fang 2021](#)]. Nevertheless, the IEEE 802.11 MAC/PHY could be extended to improve the operation of IEEE 802.1 TSN features and achieve better performance metrics [[Cavalcanti1287](#)].

TSN capabilities supported over 802.11 (which also extends to 802.11ax), include:

1. 802.1AS based Time Synchronization (other time synchronization techniques may also be used)
2. Interoperating with IEEE802.1Q bridges
3. Time-sensitive Traffic Stream Classification

The existing 802.11 TSN capabilities listed above, and the 802.11ax OFDMA and AP-controlled access within a BSS provide a new set of tools to better serve time-sensitive flows. However, it is important to understand the tradeoffs and constraints associated with such capabilities, as well as redundancy and diversity mechanisms that can be used to provide more predictable and reliable performance.

4.2.2.1. 802.11 Managed network operation and admission control

Time-sensitive applications and TSN standards are expected to operate under a managed network (e.g. industrial/enterprise network). Thus, the Wi-Fi operation must also be carefully managed and integrated with the overall TSN management framework, as defined in the [[IEEE802.1Qcc](#)] specification.

Some of the random-access latency and interference from legacy/unmanaged devices can be reduced under a centralized management mode as defined in [[IEEE802.1Qcc](#)].

Existing traffic stream identification, configuration and admission control procedures defined in [[IEEE Std 802.11](#)] QoS mechanism can be re-used. However, given the high degree of determinism required by many time-sensitive applications, additional capabilities to manage interference and legacy devices within tight time-constraints need to be explored.

4.2.2.2. Scheduling for bounded latency and diversity

As discussed earlier, the [[IEEE Std 802.11ax](#)] OFDMA mode introduces the possibility of assigning different RUs (time/frequency resources) to users within a PPDU. Several RU sizes are defined in the specification (26, 52, 106, 242, 484, 996 subcarriers). In addition, the AP can also decide on MCS and grouping of users within a given OFDMA PPDU. Such flexibility can be leveraged to support time-sensitive applications with bounded latency, especially in a managed network where stations can be configured to operate under the control of the AP, in a controlled environment (which contains only devices operating on the unlicensed band installed by the facility owner and where unexpected interference from other systems and/or radio access technologies only sporadically happens), or in a

deployment where channel/link redundancy is used to reduce the impact of unmanaged devices/interference.

When the network is lightly loaded, it is possible to achieve latencies under 1 msec when Wi-Fi is operated in contention-based (i.e., without OFDMA) mode. It has also been shown that it is possible to achieve 1 msec latencies in a controlled environment with higher efficiency when multi-user transmissions are used (enabled by OFDMA operation) [[Cavalcanti 2019](#)]. Obviously, there are latency, reliability and capacity tradeoffs to be considered. For instance, smaller RUs result in longer transmission durations, which may impact the minimal latency that can be achieved, but the contention latency and randomness elimination in an interference-free environment due to multi-user transmission is a major benefit of the OFDMA mode.

The flexibility to dynamically assign RUs to each transmission also enables the AP to provide frequency diversity, which can help increase reliability.

4.3. 802.11be Extreme High Throughput (EHT)

4.3.1. General Characteristics

The ongoing [[IEEE 802.11be WIP](#)] project is the next major 802.11 amendment (after IEEE Std 802.11ax-2021) for operation in the 2.4, 5 and 6 GHz bands. 802.11be is expected to include new PHY and MAC features and it is targeting extremely high throughput (at least 30 Gbps), as well as enhancements to worst case latency and jitter. It is also expected to improve the integration with 802.1 TSN to support time-sensitive applications over Ethernet and Wireless LANs.

The 802.11be Task Group started its operation in May 2019, therefore, detailed information about specific features is not yet available. Only high level candidate features have been discussed so far, including:

1. 320MHz bandwidth and more efficient utilization of non-contiguous spectrum.
2. Multi-link operation.
3. 16 spatial streams and related MIMO enhancements.
4. Multi-Access Point (AP) Coordination.
5. Enhanced link adaptation and retransmission protocol, e.g. Hybrid Automatic Repeat Request (HARQ).
6. Any required adaptations to regulatory rules for the 6 GHz spectrum.

4.3.2. Applicability to deterministic flows

The 802.11 Real-Time Applications (RTA) Topic Interest Group (TIG) provided detailed information on use cases, issues and potential solution directions to improve support for time-sensitive applications in 802.11. The RTA TIG report [[IEEE doc 11-18-2009-06](#)] was used as input to the 802.11be project scope.

Improvements for worst-case latency, jitter and reliability were the main topics identified in the RTA report, which were motivated by applications in gaming, industrial automation, robotics, etc. The RTA report also highlighted the need to support additional TSN capabilities, such as time-aware (802.1Qbv) shaping and packet replication and elimination as defined in 802.1CB.

802.11be is expected to build on and enhance 802.11ax capabilities to improve worst case latency and jitter. Some of the enhancement areas are discussed next.

4.3.2.1. Enhanced scheduled operation for bounded latency

In addition to the throughput enhancements, 802.11be will leverage the trigger-based scheduled operation enabled by 802.11ax to provide efficient and more predictable medium access. 802.11be is expected to include enhancements to reduce overhead and enable more efficient operation in managed network deployments [[IEEE doc 11-19-0373-00](#)].

4.3.2.2. Multi-AP coordination

Multi-AP coordination is one of the main new candidate features in 802.11be. It can provide benefits in throughput and capacity and has the potential to address some of the issues that impact worst case latency and reliability. Multi-AP coordination is expected to address the contention due to overlapping Basic Service Sets (OBSS),

which is one of the main sources of random latency variations. 802.11be can define methods to enable better coordination between APs, for instance, in a managed network scenario, in order to reduce latency due to unmanaged contention.

Overall, multi-AP coordination algorithms consider three different phases: setup (where APs handling overlapping BSSs are assigned roles in a manual or automated way, e.g., coordinator and coordinated APs); coordination (where APs establish links among themselves, e.g., from a coordinating AP to coordinated APs; and then assign resources to served stations); transmission (where the coordinating APs optimize the distribution of the transmission opportunities).

Several multi-AP coordination approaches have been discussed with different levels of complexities and benefits, but specific coordination methods have not yet been defined. Out of the different categories, MAC-driven examples include: coordinated OFDMA (Co-OFDMA); Coordinated TDMA (Co-TDMA); HARQ; whereas PHY-driven examples include: Coordinated Spatial Reuse (Co-SR) and Coordinated Beamforming (Co-BF).

4.3.2.3. Multi-link operation

802.11be will introduce new features to improve operation over multiple links and channels. By leveraging multiple links/channels, 802.11be can isolate time-sensitive traffic from network congestion, one of the main causes of large latency variations. In a managed 802.11be network, it should be possible to steer traffic to certain links/channels to isolate time-sensitive traffic from other traffic and help achieve bounded latency. The multi-link operation (MLO) has been already introduced in the 802.be Draft and it can also enhance latency and reliability by enabling data frames to be duplicated across links.

4.4. 802.11ad and 802.11ay (mmWave operation)

4.4.1. General Characteristics

The IEEE 802.11ad amendment defines PHY and MAC capabilities to enable multi-Gbps throughput in the 60 GHz millimeter wave (mmWave) band. The standard addresses the adverse mmWave signal propagation characteristics and provides directional communication capabilities that take advantage of beamforming to cope with increased attenuation. An overview of the 802.11ad standard can be found in [[Nitsche 2015](#)] .

The IEEE 802.11ay is currently developing enhancements to the 802.11ad standard to enable the next generation mmWave operation targeting 100 Gbps throughput. Some of the main enhancements in

802.11ay include MIMO, channel bonding, improved channel access and beamforming training. An overview of the 802.11ay capabilities can be found in [[Ghasempour 2017](#)]

4.4.2. Applicability to deterministic flows

The high data rates achievable with 802.11ad and 802.11ay can significantly reduce latency down to microsecond levels. Limited interference from legacy and other unlicensed devices in 60 GHz is also a benefit. However, directionality and short range typical in mmWave operation impose new challenges such as the overhead required for beam training and blockage issues, which impact both latency and reliability. Therefore, it is important to understand the use case and deployment conditions in order to properly apply and configure 802.11ad/ay networks for time sensitive applications.

The 802.11ad standard includes a scheduled access mode in which the central controller, after contending and reserving the channel for a dedicated period, can allocate to stations contention-free service periods. This scheduling capability is also available in 802.11ay, and it is one of the mechanisms that can be used to provide bounded latency to time-sensitive data flows in interference-free scenarios. An analysis of the theoretical latency bounds that can be achieved with 802.11ad service periods is provided in [[Cavalcanti 2019](#)].

5. IEEE 802.15.4

5.1. Provenance and Documents

The IEEE802.15.4 Task Group has been driving the development of low-power low-cost radio technology. The IEEE802.15.4 physical layer has been designed to support demanding low-power scenarios targeting the use of unlicensed bands, both the 2.4 GHz and sub GHz Industrial, Scientific and Medical (ISM) bands. This has imposed requirements in terms of frame size, data rate and bandwidth to achieve reduced collision probability, reduced packet error rate, and acceptable range with limited transmission power. The PHY layer supports frames of up to 127 bytes. The Medium Access Control (MAC) sublayer overhead is in the order of 10-20 bytes, leaving about 100 bytes to the upper layers. IEEE802.15.4 uses spread spectrum modulation such as the Direct Sequence Spread Spectrum (DSSS).

The Timeslotted Channel Hopping (TSCH) mode was added to the 2015 revision of the IEEE802.15.4 standard [[IEEE Std 802.15.4](#)]. TSCH is targeted at the embedded and industrial world, where reliability, energy consumption and cost drive the application space.

At the IETF, the 6TiSCH Working Group (WG) [[TiSCH](#)] deals with best effort operation of IPv6 [[RFC8200](#)] over TSCH. 6TiSCH has enabled distributed scheduling to exploit the deterministic access

capabilities provided by TSCH. The group designed the essential mechanisms to enable the management plane operation while ensuring IPv6 is supported. Yet the charter did not focus to providing a solution to establish end to end Tracks while meeting quality of service requirements. 6TiSCH, through the RFC8480 [[RFC8480](#)] defines the 6P protocol which provides a pairwise negotiation mechanism to the control plane operation. The protocol supports agreement on a schedule between neighbors, enabling distributed scheduling. 6P goes hand-in-hand with a Scheduling Function (SF), the policy that decides how to maintain cells and trigger 6P transactions. The Minimal Scheduling Function (MSF) [[RFC9033](#)] is the default SF defined by the 6TiSCH WG; other standardized SFs can be defined in the future. MSF extends the minimal schedule configuration, and is used to add child-parent links according to the traffic load.

Time sensitive networking on low power constrained wireless networks have been partially addressed by ISA100.11a [[ISA100.11a](#)] and WirelessHART [[WirelessHART](#)]. Both technologies involve a central controller that computes redundant paths for industrial process control traffic over a TSCH mesh. Moreover, ISA100.11a introduces IPv6 capabilities with a Link-Local Address for the join process and a global unicast address for later exchanges, but the IPv6 traffic typically ends at a local application gateway and the full power of IPv6 for end-to-end communication is not enabled. Compared to that state of the art, work at the IETF and in particular at RAW could provide additional techniques such as optimized P2P routing, PAREO functions, and end-to-end secured IPv6/CoAP connectivity.

The 6TiSCH architecture [[RFC9030](#)] identifies different models to schedule resources along so-called Tracks (see [Section 5.2.2.2](#)) exploiting the TSCH schedule structure however the focus at 6TiSCH is on best effort traffic and the group was never chartered to produce standard work related to Tracks.

Useful References include:

1. IEEE Std 802.15.4: "IEEE Std 802.15.4, Part. 15.4: Wireless Medium Access Control (MAC) and Physical Layer (PHY) Specifications for Low-Rate Wireless Personal Area Networks" [[IEEE Std 802.15.4](#)]. The latest version at the time of this writing is dated year 2015.
2. Morell, A. , Vilajosana, X. , Vicario, J. L. and Watteyne, T. (2013), Label switching over IEEE802.15.4e networks. Trans. Emerging Tel. Tech., 24: 458-475. doi:10.1002/ett.2650" [[morell13](#)].
3. De Armas, J., Tuset, P., Chang, T., Adelantado, F., Watteyne, T., Vilajosana, X. (2016, September). Determinism through path

diversity: Why packet replication makes sense. In 2016 International Conference on Intelligent Networking and Collaborative Systems (INCoS) (pp. 150-154). IEEE. [[dearmas16](#)].

4. X. Vilajosana, T. Watteyne, M. Vucinic, T. Chang and K. S. J. Pister, "6TiSCH: Industrial Performance for IPv6 Internet-of-Things Networks," in Proceedings of the IEEE, vol. 107, no. 6, pp. 1153-1165, June 2019. [[vilajosana19](#)].

5.2. TimeSlotted Channel Hopping

5.2.1. General Characteristics

As a core technique in IEEE802.15.4, TSCH splits time in multiple time slots that repeat over time. A set of timeslots constructs a Slotframe (see [Section 5.2.2.1.4](#)). For each timeslot, a set of available frequencies can be used, resulting in a matrix-like schedule (see [Figure 1](#)).

		timeslot offset											
		0	1	2	3	4	0	1	2	3	4	Nodes	
CH-1		EB			C->B		EB			C->B		C	
CH-2				B->C		B->A			B->C		B->A	B	
...													
CH-15			A->B				A->B					A	

ch.
offset

Figure 1: Slotframe example with scheduled cells between nodes A, B and C

This schedule represents the possible communications of a node with its neighbors, and is managed by a Scheduling Function such as the Minimal Scheduling Function (MSF) [[RFC9033](#)]. Each cell in the schedule is identified by its slotoffset and channeloffset coordinates. A cell's timeslot offset indicates its position in

time, relative to the beginning of the slotframe. A cell's channel offset is an index which maps to a frequency at each iteration of the slotframe. Each packet exchanged between neighbors happens within one cell. The size of a cell is a timeslot duration, between 10 to 15 milliseconds. An Absolute Slot Number (ASN) indicates the number of slots elapsed since the network started. It increments at every slot. This is a 5 byte counter that can support networks running for more than 300 years without wrapping (assuming a 10 ms timeslot). Channel hopping provides increased reliability to multipath fading and external interference. It is handled by TSCH through a channel hopping sequence referred as macHopSeq in the IEEE802.15.4 specification.

The Time-Frequency Division Multiple Access provided by TSCH enables the orchestration of traffic flows, spreading them in time and frequency, and hence enabling an efficient management of the bandwidth utilization. Such efficient bandwidth utilization can be combined to OFDM modulations also supported by the IEEE802.15.4 standard [[IEEE Std 802.15.4](#)] since the 2015 version.

TSCH networks operate in ISM bands in which the spectrum is shared by different coexisting technologies. Regulations such as FCC, ETSI and ARIB impose duty cycle regulations to limit the use of the bands but yet interference may constraint the probability to deliver a packet. Part of these reliability challenges are addressed at the MAC introducing redundancy and diversity, thanks to channel hopping, scheduling and ARQ policies. Yet, the MAC layer operates with a 1-hop vision, being limited to local actions to mitigate underperforming links.

In the RAW context, low power reliable networks should address non-critical control scenarios such as Class 2 and monitoring scenarios such as Class 4 defined by the RFC5673 [[RFC5673](#)]. As a low power technology targeting industrial scenarios radio transducers provide low data rates (typically between 50kbps to 250kbps) and robust modulations to trade-off performance to reliability. TSCH networks are organized in mesh topologies and connected to a backbone. Latency in the mesh network is mainly influenced by propagation aspects such as interference. ARQ methods and redundancy techniques such as replication and elimination should be studied to provide the needed performance to address deterministic scenarios.

5.2.2. Applicability to Deterministic Flows

Nodes in a TSCH network are tightly synchronized. This enables to build the slotted structure and ensure efficient utilization of resources thanks to proper scheduling policies. Scheduling is a key to orchestrate the resources that different nodes in a Track or a path are using. Slotframes can be split in resource blocks reserving

the needed capacity to certain flows. Periodic and bursty traffic can be handled independently in the schedule, using active and reactive policies and taking advantage of overprovisioned cells to measure excursion. Along a Track, resource blocks can be chained so nodes in previous hops transmit their data before the next packet comes. This provides a tight control to latency along a Track. Collision loss is avoided for best effort traffic by overprovisioning resources, giving time to the management plane of the network to dedicate more resources if needed.

5.2.2.1. Centralized Path Computation

In a controlled environment, a 6TiSCH device usually does not place a request for bandwidth between itself and another device in the network. Rather, an Operation Control System (OCS) invoked through an Human/Machine Interface (HMI) provides the Traffic Specification, in particular in terms of latency and reliability, and the end nodes, to a Path Computation element (PCE). With this, the PCE computes a Track between the end nodes and provisions every hop in the Track with per-flow state that describes the per-hop operation for a given packet, the corresponding timeSlots, and the flow identification to recognize which packet is placed in which Track, sort out duplicates, etc. In [Figure 2](#), an example of Operational Control System and HMI is depicted.

For a static configuration that serves a certain purpose for a long period of time, it is expected that a node will be provisioned in one shot with a full schedule, which incorporates the aggregation of its behavior for multiple Tracks. The 6TiSCH Architecture expects that the programming of the schedule is done over CoAP as discussed in ["6TiSCH Resource Management and Interaction using CoAP"](#) [[I-D.ietf-6tisch-coap](#)].

But a Hybrid mode may be required as well whereby a single Track is added, modified, or removed, for instance if it appears that a Track does not perform as expected for, say, Packet Delivery Ratio (PDR). For that case, the expectation is that a protocol that flows along a Track (to be), in a fashion similar to classical Traffic Engineering (TE) [[CCAMP](#)], may be used to update the state in the devices. 6TiSCH provides means for a device to negotiate a timeSlot with a neighbor, but in general that flow was not designed and no protocol was selected and it is expected that DetNet will determine the appropriate end-to-end protocols to be used in that case.

Stream Management Entity

Operational Control System and HMI

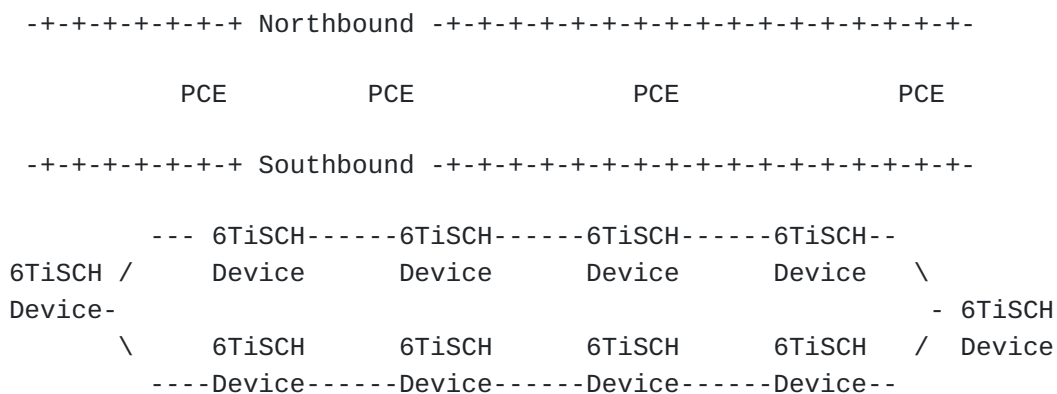

Figure 2

5.2.2.1.1. Packet Marking and Handling

Section "Packet Marking and Handling" of [\[RFC9030\]](#) describes the packet tagging and marking that is expected in 6TiSCH networks.

5.2.2.1.1.1. Tagging Packets for Flow Identification

For packets that are routed by a PCE along a Track, the tuple formed by the IPv6 source address and a local RPLInstanceID is tagged in the packets to identify uniquely the Track and associated transmit bundle of timeSlots.

It results that the tagging that is used for a DetNet flow outside the 6TiSCH LLN MUST be swapped into 6TiSCH formats and back as the packet enters and then leaves the 6TiSCH network.

Note: The method and format used for encoding the RPLInstanceID at 6lo is generalized to all 6TiSCH topological Instances, which includes Tracks.

5.2.2.1.1.2. Replication, Retries and Elimination

The 6TiSCH Architecture [\[RFC9030\]](#) leverages the Packet Replication, Retries and Elimination (PRE) functions (PREF), the precursor to what the RAW Architecture [\[I-D.ietf-raw-architecture\]](#) calls PAREO functions. PREF establishes several paths in a network to provide redundancy and parallel transmissions to bound the end-to-end delay. Considering the scenario shown in [Figure 3](#), many different paths are possible for S to reach R. A simple way to benefit from this topology could be to use the two independent paths via nodes A, C, E and via B, D, F. But more complex paths are possible as well.

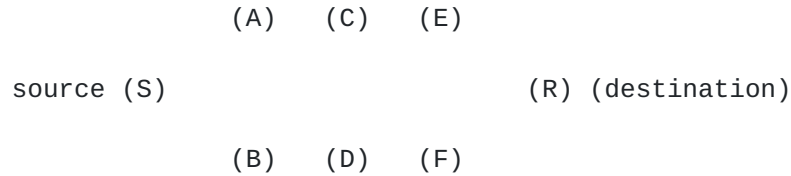

Figure 3: A Typical Ladder Shape with Two Parallel Paths Toward the Destination

By employing a Packet Replication function, each node forwards a copy of each data packet over two different branches. For instance, in [Figure 4](#), the source node S transmits the data packet to nodes A and B, in two different timeslots within the same TSCH slotframe.

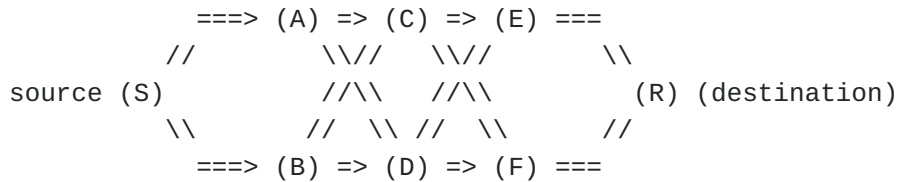

Figure 4: Packet Replication: S transmits twice the same data packet, to its DP (A) and to its AP (B).

By employing Packet Elimination function once a node receives the first copy of a data packet, it discards the subsequent copies. Because the first copy that reaches a node is the one that matters, it is the only copy that will be forwarded upward.

Considering that the wireless medium is broadcast by nature, any neighbor of a transmitter may overhear a transmission. By employing the Promiscuous Overhearing function, nodes will have multiple opportunities to receive a given data packet. For instance, in [Figure 4](#), when the source node S transmits the data packet to node A, node B may overhear this transmission.

6TiSCH expects elimination and replication of packets along a complex Track, but has no position about how the sequence numbers would be tagged in the packet.

As it goes, 6TiSCH expects that timeSlots corresponding to copies of a same packet along a Track are correlated by configuration, and does not need to process the sequence numbers.

The semantics of the configuration MUST enable correlated timeSlots to be grouped for transmit (and respectively receive) with

a'OR'relations, and then a'AND'relation MUST be configurable between groups. The semantics is that if the transmit (and respectively receive) operation succeeded in one timeSlot in a'OR'group, then all the other timeSlots in the group are ignored. Now, if there are at least two groups, the'AND'relation between the groups indicates that one operation must succeed in each of the groups.

On the transmit side, timeSlots provisioned for retries along a same branch of a Track are placed a same'OR'group. The'OR'relation indicates that if a transmission is acknowledged, then further transmissions SHOULD NOT be attempted for timeSlots in that group. There are as many'OR'groups as there are branches of the Track departing from this node. Different'OR'groups are programmed for the purpose of replication, each group corresponding to one branch of the Track. The'AND'relation between the groups indicates that transmission over any of branches MUST be attempted regardless of whether a transmission succeeded in another branch. It is also possible to place cells to different next-hop routers in a same'OR'group. This allows to route along multi-path Tracks, trying one next-hop and then another only if sending to the first fails.

On the receive side, all timeSlots are programmed in a same'OR'group. Retries of a same copy as well as converging branches for elimination are converged, meaning that the first successful reception is enough and that all the other timeSlots can be ignored.

5.2.2.1.2. Topology and capabilities

6TiSCH nodes are usually IoT devices, characterized by very limited amount of memory, just enough buffers to store one or a few IPv6 packets, and limited bandwidth between peers. It results that a node will maintain only a small number of peering information, and will not be able to store many packets waiting to be forwarded. Peers can be identified through MAC or IPv6 addresses.

Neighbors can be discovered over the radio using mechanism such as Enhanced Beacons, but, though the neighbor information is available in the 6TiSCH interface data model, 6TiSCH does not describe a protocol to pro-actively push the neighborhood information to a PCE. This protocol should be described and should operate over CoAP. The protocol should be able to carry multiple metrics, in particular the same metrics as used for RPL operations [[RFC6551](#)].

The energy that the device consumes in sleep, transmit and receive modes can be evaluated and reported. So can the amount of energy that is stored in the device and the power that it can be scavenged from the environment. The PCE SHOULD be able to compute Tracks that will implement policies on how the energy is consumed, for instance

balance between nodes, ensure that the spent energy does not exceeded the scavenged energy over a period of time, etc...

5.2.2.1.3. Schedule Management by a PCE

6TiSCH supports a mixed model of centralized routes and distributed routes. Centralized routes can for example be computed by a entity such as a PCE [[PCE](#)]. Distributed routes are computed by [RPL](#) [[RFC6550](#)].

Both methods may inject routes in the Routing Tables of the 6TiSCH routers. In either case, each route is associated with a 6TiSCH topology that can be a RPL Instance topology or a Track. The 6TiSCH topology is indexed by a Instance ID, in a format that reuses the RPLInstanceID as defined in RPL.

Both RPL and PCE rely on shared sources such as policies to define Global and Local RPLInstanceIDs that can be used by either method. It is possible for centralized and distributed routing to share a same topology. Generally they will operate in different slotFrames, and centralized routes will be used for scheduled traffic and will have precedence over distributed routes in case of conflict between the slotFrames.

5.2.2.1.4. SlotFrames and Priorities

A slotFrame is the base object that a PCE needs to manipulate to program a schedule into an LLN node. Elaboration on that concept can be found in section "SlotFrames and Priorities" of [[RFC9030](#)]

IEEE802.15.4 TSCH avoids contention on the medium by formatting time and frequencies in cells of transmission of equal duration. In order to describe that formatting of time and frequencies, the 6TiSCH architecture defines a global concept that is called a Channel Distribution and Usage (CDU) matrix; a CDU matrix is a matrix of cells with an height equal to the number of available channels (indexed by ChannelOffsets) and a width (in timeSlots) that is the period of the network scheduling operation (indexed by slotOffsets) for that CDU matrix. The size of a cell is a timeSlot duration, and values of 10 to 15 milliseconds are typical in 802.15.4 TSCH to accommodate for the transmission of a frame and an acknowledgement, including the security validation on the receive side which may take up to a few milliseconds on some device architecture.

The frequency used by a cell in the matrix rotates in a pseudo-random fashion, from an initial position at an epoch time, as the matrix iterates over and over.

A CDU matrix is computed by the PCE, but unallocated timeSlots may be used opportunistically by the nodes for classical best effort IP

traffic. The PCE has precedence in the allocation in case of a conflict.

In a given network, there might be multiple CDU matrices that operate with different width, so they have different durations and represent different periodic operations. It is recommended that all CDU matrices in a 6TiSCH domain operate with the same cell duration and are aligned, so as to reduce the chances of interferences from slotted-aloah operations. The PCE MUST compute the CDU matrices and shared that knowledge with all the nodes. The matrices are used in particular to define slotFrames.

A slotFrame is a MAC-level abstraction that is common to all nodes and contains a series of timeSlots of equal length and precedence. It is characterized by a slotFrame_ID, and a slotFrame_size. A slotFrame aligns to a CDU matrix for its parameters, such as number and duration of timeSlots.

Multiple slotFrames can coexist in a node schedule, i.e., a node can have multiple activities scheduled in different slotFrames, based on the precedence of the 6TiSCH topologies. The slotFrames may be aligned to different CDU matrices and thus have different width. There is typically one slotFrame for scheduled traffic that has the highest precedence and one or more slotFrame(s) for RPL traffic. The timeSlots in the slotFrame are indexed by the SlotOffset; the first cell is at SlotOffset 0.

The 6TiSCH architecture introduces the concept of chunks ([RFC9030]) to operate such spectrum distribution for a whole group of cells at a time. The CDU matrix is formatted into a set of chunks, each of them identified uniquely by a chunk-ID, see Figure 5. The PCE MUST compute the partitioning of CDU matrices into chunks and shared that knowledge with all the nodes in a 6TiSCH network.

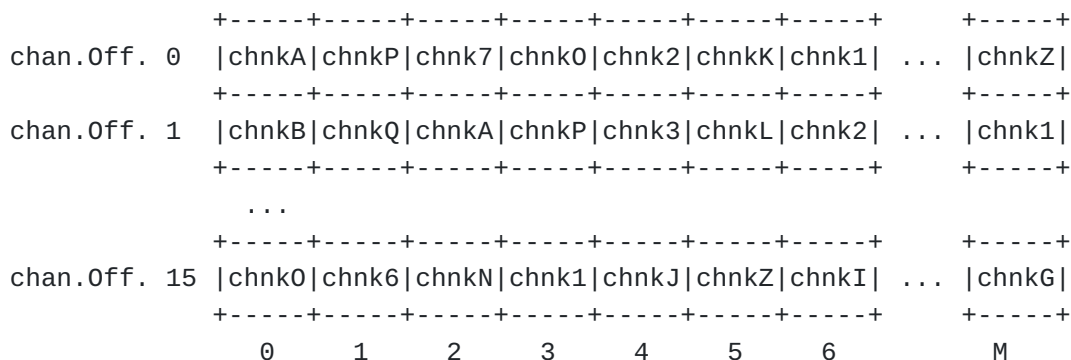

Figure 5: CDU matrix Partitioning in Chunks

The appropriation of a chunk can be requested explicitly by the PCE to any node. After a successful appropriation, the PCE owns the cells in that chunk, and may use them as hard cells to set up Tracks. Then again, 6TiSCH did not propose a method for chunk definition and a protocol for appropriation. This is to be done at RAW.

5.2.2.2. 6TiSCH Tracks

A Track at 6TiSCH is the application to wireless of the concept of a path in the "[Detnet architecture](#)" [RFC8655]. A Track can follow a simple sequence of relay nodes or can be structured as a more complex Destination Oriented Directed Acyclic Graph (DODAG) to a unicast destination. Along a Track, 6TiSCH nodes reserve the resources to enable the efficient transmission of packets while aiming to optimize certain properties such as reliability and ensure small jitter or bounded latency. The Track structure enables Layer-2 forwarding schemes, reducing the overhead of taking routing decisions at the Layer-3.

Serial Tracks can be understood as the concatenation of cells or bundles along a routing path from a source towards a destination. The serial Track concept is analogous to the circuit concept where resources are chained through the multi-hop topology. For example, A bundle of Tx Cells in a particular node is paired to a bundle of Rx Cells in the next hop node following a routing path.

Whereas scheduling ensures reliable delivery in bounded time along any Track, high availability requires the application of PAREO functions along a more complex DODAG Track structure. A DODAG has forking and joining nodes where the concepts such as Replication and Elimination can be exploited. Spatial redundancy increases the overall energy consumption in the network but improves significantly the availability of the network as well as the packet delivery ratio. A Track may also branch off and rejoin, for the purpose of the so-called Packet Replication and Elimination (PRE), over non congruent branches. PRE may be used to complement layer-2 Automatic Repeat reQuest (ARQ) and receiver-end Ordering to form the PAREO functions. PAREO functions enable to meet industrial expectations in PDR within bounded delivery time over a Track that includes wireless links, even when the Track extends beyond the 6TiSCH network.

The RAW Track described in the RAW Architecture [[I-D.ietf-raw-architecture](#)] inherits directly from that model. RAW extends the graph beyond a DODAG as long as a given packet cannot loop within the Track.

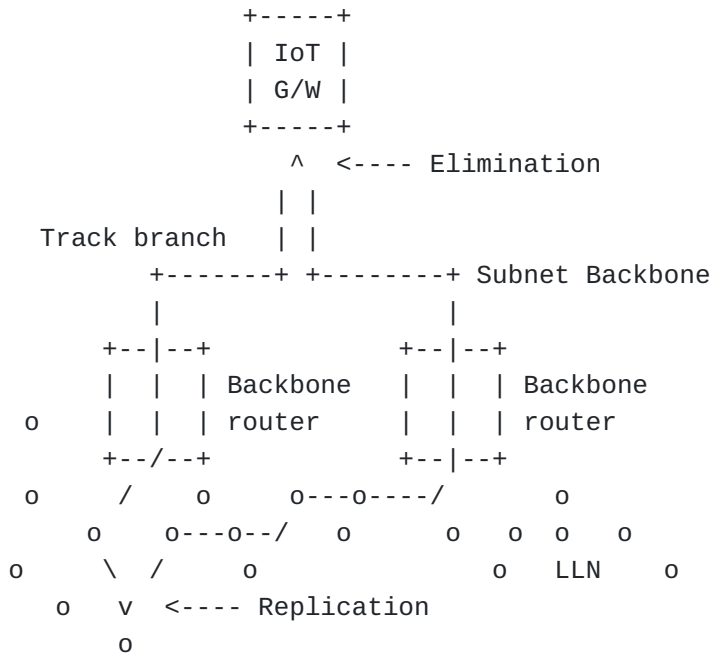

Figure 6: End-to-End deterministic Track

In the example above (see [Figure 6](#)), a Track is laid out from a field device in a 6TiSCH network to an IoT gateway that is located on a IEEE802.1 TSN backbone.

The Replication function in the field device sends a copy of each packet over two different branches, and a PCE schedules each hop of both branches so that the two copies arrive in due time at the gateway. In case of a loss on one branch, hopefully the other copy of the packet still makes it in due time. If two copies make it to the IoT gateway, the Elimination function in the gateway ignores the extra packet and presents only one copy to upper layers.

At each 6TiSCH hop along the Track, the PCE may schedule more than one timeSlot for a packet, so as to support Layer-2 retries (ARQ). It is also possible that the field device only uses the second branch if sending over the first branch fails.

In current deployments, a TSCH Track does not necessarily support PRE but is systematically multi-path. This means that a Track is scheduled so as to ensure that each hop has at least two forwarding solutions, and the forwarding decision is to try the preferred one and use the other in case of Layer-2 transmission failure as detected by ARQ.

Methods to implement complex Tracks are described in [\[I-D.papadopoulos-paw-pre-reqs\]](#) and complemented by extensions to

the RPL routing protocol in [[I-D.ietf-roll-nsa-extension](#)] for best effort traffic, but a centralized routing technique such as promoted in DetNet is still missing.

5.2.2.2.1. Track Scheduling Protocol

Section "Schedule Management Mechanisms" of the 6TiSCH architecture describes 4 paradigms to manage the TSCH schedule of the LLN nodes: Static Scheduling, neighbor-to-neighbor Scheduling, remote monitoring and scheduling management, and Hop-by-hop scheduling. The Track operation for DetNet corresponds to a remote monitoring and scheduling management by a PCE.

Early work at 6TiSCH on a data model and a protocol to program the schedule in the 6TiSCH device was never concluded as the group focussed on best effort traffic. This work would be revived by RAW:

The 6top interface document [[RFC8480](#)] (to be reopened at RAW) was intended to specify the generic data model that can be used to monitor and manage resources of the 6top sublayer. Abstract methods were suggested for use by a management entity in the device. The data model also enables remote control operations on the 6top sublayer.

[[I-D.ietf-6tisch-coap](#)] (to be reopened at RAW) was intended to define a mapping of the 6top set of commands, which is described in RFC 8480, to CoAP resources. This allows an entity to interact with the 6top layer of a node that is multiple hops away in a RESTful fashion.

[[I-D.ietf-6tisch-coap](#)] also defined a basic set CoAP resources and associated RESTful access methods (GET/PUT/POST/DELETE). The payload (body) of the CoAP messages is encoded using the CBOR format. The PCE commands are expected to be issued directly as CoAP requests or to be mapped back and forth into CoAP by a gateway function at the edge of the 6TiSCH network. For instance, it is possible that a mapping entity on the backbone transforms a non-CoAP protocol such as PCEP into the RESTful interfaces that the 6TiSCH devices support.

5.2.2.2.2. Track Forwarding

By forwarding, this specification means the per-packet operation that allows to deliver a packet to a next hop or an upper layer in this node. Forwarding is based on pre-existing state that was installed as a result of the routing computation of a Track by a PCE. The 6TiSCH architecture supports three different forwarding model, G-MPLS Track Forwarding (TF), 6LoWPAN Fragment Forwarding (FF) and IPv6 Forwarding (6F) which is the classical IP operation

[[RFC9030](#)]. The DetNet case relates to the Track Forwarding operation under the control of a PCE.

A Track is a unidirectional path between a source and a destination. In a Track cell, the normal operation of IEEE802.15.4 Automatic Repeat-reQuest (ARQ) usually happens, though the acknowledgment may be omitted in some cases, for instance if there is no scheduled cell for a retry.

Track Forwarding is the simplest and fastest. A bundle of cells set to receive (RX-cells) is uniquely paired to a bundle of cells that are set to transmit (TX-cells), representing a layer-2 forwarding state that can be used regardless of the network layer protocol. This model can effectively be seen as a Generalized Multi-protocol Label Switching (G-MPLS) operation in that the information used to switch a frame is not an explicit label, but rather related to other properties of the way the packet was received, a particular cell in the case of 6TiSCH. As a result, as long as the TSCH MAC (and Layer-2 security) accepts a frame, that frame can be switched regardless of the protocol, whether this is an IPv6 packet, a 6LoWPAN fragment, or a frame from an alternate protocol such as WirelessHART or ISA100.11a.

A data frame that is forwarded along a Track normally has a destination MAC address that is set to broadcast - or a multicast address depending on MAC support. This way, the MAC layer in the intermediate nodes accepts the incoming frame and 6top switches it without incurring a change in the MAC header. In the case of IEEE802.15.4, this means effectively broadcast, so that along the Track the short address for the destination of the frame is set to 0xFFFF.

A Track is thus formed end-to-end as a succession of paired bundles, a receive bundle from the previous hop and a transmit bundle to the next hop along the Track, and a cell in such a bundle belongs to at most one Track. For a given iteration of the device schedule, the effective channel of the cell is obtained by adding a pseudo-random number to the channelOffset of the cell, which results in a rotation of the frequency that used for transmission. The bundles may be computed so as to accommodate both variable rates and retransmissions, so they might not be fully used at a given iteration of the schedule. The 6TiSCH architecture provides additional means to avoid waste of cells as well as overflows in the transmit bundle, as follows:

In one hand, a TX-cell that is not needed for the current iteration may be reused opportunistically on a per-hop basis for routed packets. When all of the frame that were received for a given Track are effectively transmitted, any available TX-cell for that Track

can be reused for upper layer traffic for which the next-hop router matches the next hop along the Track. In that case, the cell that is being used is effectively a TX-cell from the Track, but the short address for the destination is that of the next-hop router. It results that a frame that is received in a RX-cell of a Track with a destination MAC address set to this node as opposed to broadcast must be extracted from the Track and delivered to the upper layer (a frame with an unrecognized MAC address is dropped at the lower MAC layer and thus is not received at the 6top sublayer).

On the other hand, it might happen that there are not enough TX-cells in the transmit bundle to accommodate the Track traffic, for instance if more retransmissions are needed than provisioned. In that case, the frame can be placed for transmission in the bundle that is used for layer-3 traffic towards the next hop along the Track as long as it can be routed by the upper layer, that is, typically, if the frame transports an IPv6 packet. The MAC address should be set to the next-hop MAC address to avoid confusion. It results that a frame that is received over a layer-3 bundle may be in fact associated to a Track. In a classical IP link such as an Ethernet, off-Track traffic is typically in excess over reservation to be routed along the non-reserved path based on its QoS setting. But with 6TiSCH, since the use of the layer-3 bundle may be due to transmission failures, it makes sense for the receiver to recognize a frame that should be re-Track, and to place it back on the appropriate bundle if possible. A frame should be re-Track if the Per-Hop-Behavior group indicated in the Differentiated Services Field in the IPv6 header is set to Deterministic Forwarding, as discussed in [Section 5.2.2.1.1](#). A frame is re-Track by scheduling it for transmission over the transmit bundle associated to the Track, with the destination MAC address set to broadcast.

There are 2 modes for a Track, transport mode and tunnel mode.

5.2.2.2.2.1. Transport Mode

In transport mode, the Protocol Data Unit (PDU) is associated with flow-dependant meta-data that refers uniquely to the Track, so the 6top sublayer can place the frame in the appropriate cell without ambiguity. In the case of IPv6 traffic, this flow identification is transported in the Flow Label of the IPv6 header. Associated with the source IPv6 address, the Flow Label forms a globally unique identifier for that particular Track that is validated at egress before restoring the destination MAC address (DMAC) and punting to the upper layer.

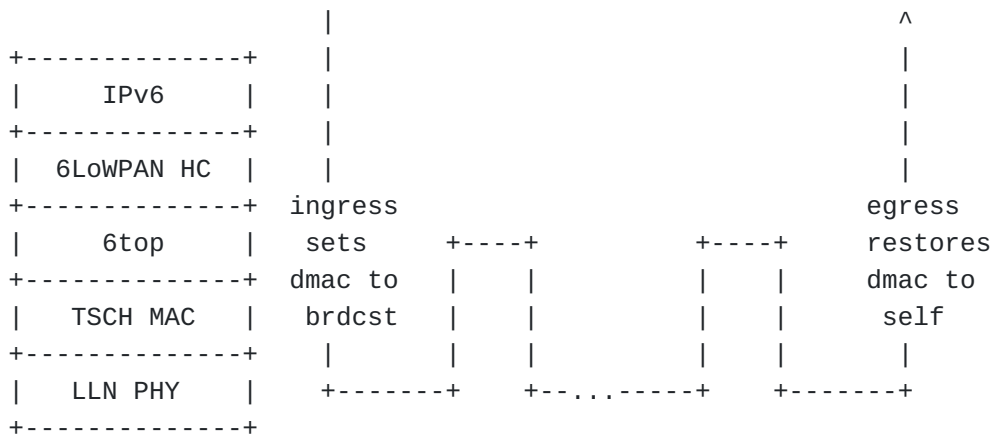

Figure 7: Track Forwarding, Transport Mode

5.2.2.2.2.2. Tunnel Mode

In tunnel mode, the frames originate from an arbitrary protocol over a compatible MAC that may or may not be synchronized with the 6TiSCH network. An example of this would be a router with a dual radio that is capable of receiving and sending WirelessHART or ISA100.11a frames with the second radio, by presenting itself as an Access Point or a Backbone Router, respectively.

In that mode, some entity (e.g. PCE) can coordinate with a WirelessHART Network Manager or an ISA100.11a System Manager to specify the flows that are to be transported transparently over the Track.

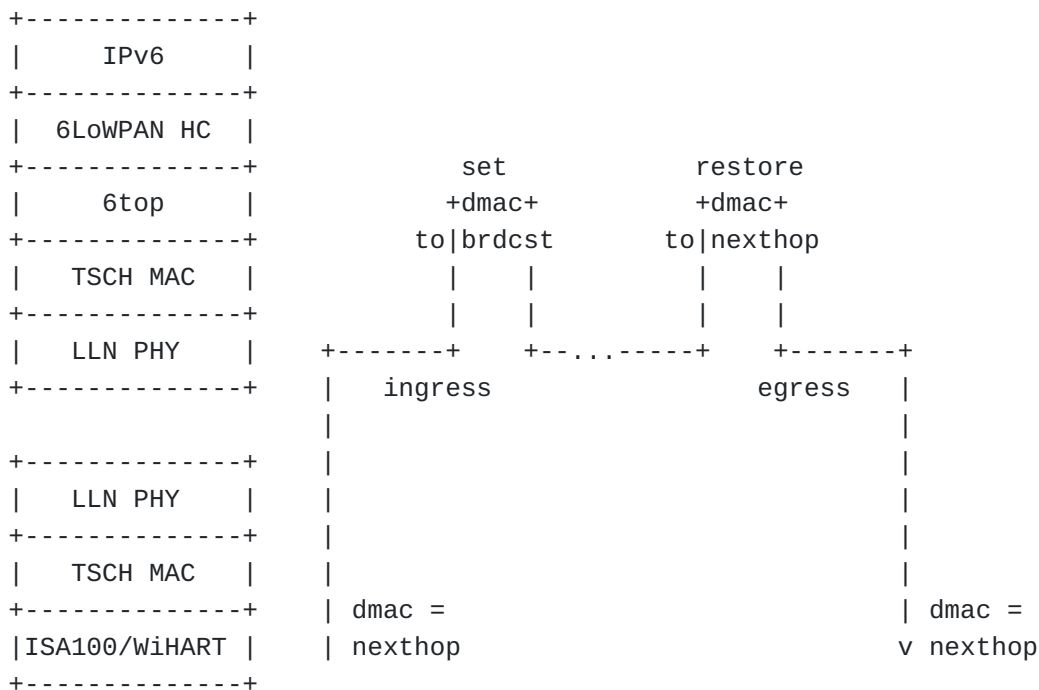

Figure 8: Track Forwarding, Tunnel Mode

In that case, the flow information that identifies the Track at the ingress 6TiSCH router is derived from the RX-cell. The dmac is set to this node but the flow information indicates that the frame must be tunneled over a particular Track so the frame is not passed to the upper layer. Instead, the dmac is forced to broadcast and the frame is passed to the 6top sublayer for switching.

At the egress 6TiSCH router, the reverse operation occurs. Based on metadata associated to the Track, the frame is passed to the appropriate link layer with the destination MAC restored.

5.2.2.2.2.3. Tunnel Metadata

Metadata coming with the Track configuration is expected to provide the destination MAC address of the egress endpoint as well as the tunnel mode and specific data depending on the mode, for instance a service access point for frame delivery at egress. If the tunnel egress point does not have a MAC address that matches the configuration, the Track installation fails.

In transport mode, if the final layer-3 destination is the tunnel termination, then it is possible that the IPV6 address of the destination is compressed at the 6LoWPAN sublayer based on the MAC address. It is thus mandatory at the ingress point to validate that the MAC address that was used at the 6LoWPAN sublayer for compression matches that of the tunnel egress point. For that reason, the node that injects a packet on a Track checks that the destination is effectively that of the tunnel egress point before it overwrites it to broadcast. The 6top sublayer at the tunnel egress point reverts that operation to the MAC address obtained from the tunnel metadata.

5.2.2.2.2.4. OAM

[An Overview of Operations, Administration, and Maintenance \(OAM\) Tools \[RFC7276\]](#) provides an overview of the existing tooling for OAM [RFC6291]. Tracks are complex paths and new tooling is necessary to manage them, with respect to load control, timing, and the Packet Replication and Elimination Functions (PREF).

An example of such tooling can be found in the context of [BIER \[RFC8279\]](#) and more specifically [BIER Traffic Engineering \[I-D.ietf-bier-te-arch\]](#) (BIER-TE): [\[I-D.thubert-bier-replication-elimination\]](#) leverages BIER-TE to control the process of PREF, and to provide traceability of these operations, in the deterministic dataplane, along a complex Track. For the 6TiSCH type of constrained environment,

[[I-D.thubert-6lo-bier-dispatch](#)] enables an efficient encoding of the BIER bitmap within the 6LoRH framework.

6. 5G

6.1. Provenance and Documents

The 3rd Generation Partnership Project (3GPP) incorporates many companies whose business is related to cellular network operation as well as network equipment and device manufacturing. All generations of 3GPP technologies provide scheduled wireless segments, primarily in licensed spectrum which is beneficial for reliability and availability.

In 2016, the 3GPP started to design New Radio (NR) technology belonging to the fifth generation (5G) of cellular networks. NR has been designed from the beginning to not only address enhanced Mobile Broadband (eMBB) services for consumer devices such as smart phones or tablets but is also tailored for future Internet of Things (IoT) communication and connected cyber-physical systems. In addition to eMBB, requirement categories have been defined on Massive Machine-Type Communication (M-MTC) for a large number of connected devices/sensors, and Ultra-Reliable Low-Latency Communication (URLLC) for connected control systems and critical communication as illustrated in [Figure 9](#). It is the URLLC capabilities that make 5G a great candidate for reliable low-latency communication. With these three corner stones, NR is a complete solution supporting the connectivity needs of consumers, enterprises, and public sector for both wide area and local area, e.g. indoor deployments. A general overview of NR can be found in [[TS38300](#)].

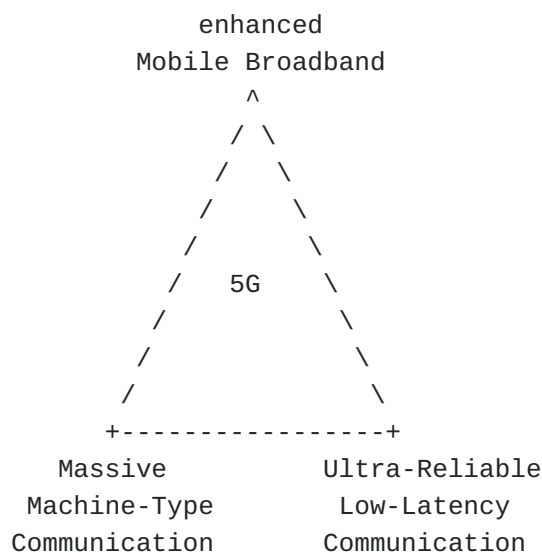

Figure 9: 5G Application Areas

As a result of releasing the first NR specification in 2018 (Release 15), it has been proven by many companies that NR is a URLLC-capable technology and can deliver data packets at 10^{-5} packet error rate within 1ms latency budget [[TR37910](#)]. Those evaluations were consolidated and forwarded to ITU to be included in the [[IMT2020](#)] work.

In order to understand communication requirements for automation in vertical domains, 3GPP studied different use cases [[TR22804](#)] and released technical specification with reliability, availability and latency demands for a variety of applications [[TS22104](#)].

As an evolution of NR, multiple studies have been conducted in scope of 3GPP Release 16 including the following two, focusing on radio aspects:

1. Study on physical layer enhancements for NR ultra-reliable and low latency communication (URLLC) [[TR38824](#)].
2. Study on NR industrial Internet of Things (I-IoT) [[TR38825](#)].

Resulting of these studies, further enhancements to NR have been standardized in 3GPP Release 16, hence, available in [[TS38300](#)], and continued in 3GPP Release 17 standardization (according to [[RP210854](#)]).

In addition, several enhancements have been done on system architecture level which are reflected in System architecture for the 5G System (5GS) [[TS23501](#)]. These enhancements include multiple features in support of Time-Sensitive Communications (TSC) by Release 16 and Release 17. Further improvements are provided in Release 18, e.g., support for DetNet [[TR2370046](#)].

The adoption and the use of 5G is facilitated by multiple organizations. For instance, the 5G Alliance for Connected Industries and Automation (5G-ACIA) brings together widely varying 5G stakeholders including Information and Communication Technology (ICT) players and Operational Technology (OT) companies, e.g.: industrial automation enterprises, machine builders, and end users. Another example is the 5G Automotive Association (5GAA), which bridges ICT and automotive technology companies to develop end-to-end solutions for future mobility and transportation services.

6.2. General Characteristics

The 5G Radio Access Network (5G RAN) with its NR interface includes several features to achieve Quality of Service (QoS), such as a guaranteeably low latency or tolerable packet error rates for selected data flows. Determinism is achieved by centralized admission control and scheduling of the wireless frequency

resources, which are typically licensed frequency bands assigned to a network operator.

NR enables short transmission slots in a radio subframe, which benefits low-latency applications. NR also introduces mini-slots, where prioritized transmissions can be started without waiting for slot boundaries, further reducing latency. As part of giving priority and faster radio access to URLLC traffic, NR introduces preemption where URLLC data transmission can preempt ongoing non-URLLC transmissions. Additionally, NR applies very fast processing, enabling retransmissions even within short latency bounds.

NR defines extra-robust transmission modes for increased reliability both for data and control radio channels. Reliability is further improved by various techniques, such as multi-antenna transmission, the use of multiple frequency carriers in parallel and packet duplication over independent radio links. NR also provides full mobility support, which is an important reliability aspect not only for devices that are moving, but also for devices located in a changing environment.

Network slicing is seen as one of the key features for 5G, allowing vertical industries to take advantage of 5G networks and services. Network slicing is about transforming a Public Land Mobile Network (PLMN) from a single network to a network where logical partitions are created, with appropriate network isolation, resources, optimized topology and specific configuration to serve various service requirements. An operator can configure and manage the mobile network to support various types of services enabled by 5G, for example eMBB and URLLC, depending on the different customers' needs.

Exposure of capabilities of 5G Systems to the network or applications outside the 3GPP domain have been added to Release 16 [[TS23501](#)]. Via exposure interfaces, applications can access 5G capabilities, e.g., communication service monitoring and network maintenance.

For several generations of mobile networks, 3GPP has considered how the communication system should work on a global scale with billions of users, taking into account resilience aspects, privacy regulation, protection of data, encryption, access and core network security, as well as interconnect. Security requirements evolve as demands on trustworthiness increase. For example, this has led to the introduction of enhanced privacy protection features in 5G. 5G also employs strong security algorithms, encryption of traffic, protection of signaling and protection of interfaces.

One particular strength of mobile networks is the authentication, based on well-proven algorithms and tightly coupled with a global identity management infrastructure. Since 3G, there is also mutual authentication, allowing the network to authenticate the device and the device to authenticate the network. Another strength is secure solutions for storage and distribution of keys fulfilling regulatory requirements and allowing international roaming. When connecting to 5G, the user meets the entire communication system, where security is the result of standardization, product security, deployment, operations and management as well as incident handling capabilities. The mobile networks approach the entirety in a rather coordinated fashion which is beneficial for security.

6.3. Deployment and Spectrum

The 5G system allows deployment in a vast spectrum range, addressing use-cases in both wide-area as well as local networks. Furthermore, 5G can be configured for public and non-public access.

When it comes to spectrum, NR allows combining the merits of many frequency bands, such as the high bandwidths in millimeter Waves (mmW) for extreme capacity locally, as well as the broad coverage when using mid- and low frequency bands to address wide-area scenarios. URLLC is achievable in all these bands. Spectrum can be either licensed, which means that the license holder is the only authorized user of that spectrum range, or unlicensed, which means that anyone who wants to use the spectrum can do so.

A prerequisite for critical communication is performance predictability, which can be achieved by the full control of the access to the spectrum, which 5G provides. Licensed spectrum guarantees control over spectrum usage by the system, making it a preferable option for critical communication. However, unlicensed spectrum can provide an additional resource for scaling non-critical communications. While NR is initially developed for usage of licensed spectrum, the functionality to access also unlicensed spectrum was introduced in 3GPP Release 16. Moreover, URLLC features are enhanced in Release 17 [[RP210854](#)] to be better applicable to unlicensed spectrum.

Licensed spectrum dedicated to mobile communications has been allocated to mobile service providers, i.e. issued as longer-term licenses by national administrations around the world. These licenses have often been associated with coverage requirements and issued across whole countries, or in large regions. Besides this, configured as a non-public network (NPN) deployment, 5G can provide network services also to a non-operator defined organization and its premises such as a factory deployment. By this isolation, quality of service requirements, as well as security requirements can be

achieved. An integration with a public network, if required, is also possible. The non-public (local) network can thus be interconnected with a public network, allowing devices to roam between the networks.

In an alternative model, some countries are now in the process of allocating parts of the 5G spectrum for local use to industries. These non-service providers then have a choice of applying for a local license themselves and operating their own network or cooperating with a public network operator or service provider.

6.4. Applicability to Deterministic Flows

6.4.1. System Architecture

The 5G system [[TS23501](#)] consists of the User Equipment (UE) at the terminal side, and the Radio Access Network (RAN) with the gNB as radio base station node, as well as the Core Network (CN). The core network is based on a service-based architecture with the central functions: Access and Mobility Management Function (AMF), Session Management Function (SMF) and User Plane Function (UPF) as illustrated in [Figure 10](#).

The gNB's main responsibility is the radio resource management, including admission control and scheduling, mobility control and radio measurement handling. The AMF handles the UE's connection status and security, while the SMF controls the UE's data sessions. The UPF handles the user plane traffic.

The SMF can instantiate various Packet Data Unit (PDU) sessions for the UE, each associated with a set of QoS flows, i.e., with different QoS profiles. Segregation of those sessions is also possible, e.g., resource isolation in the RAN and in the CN can be defined (slicing).

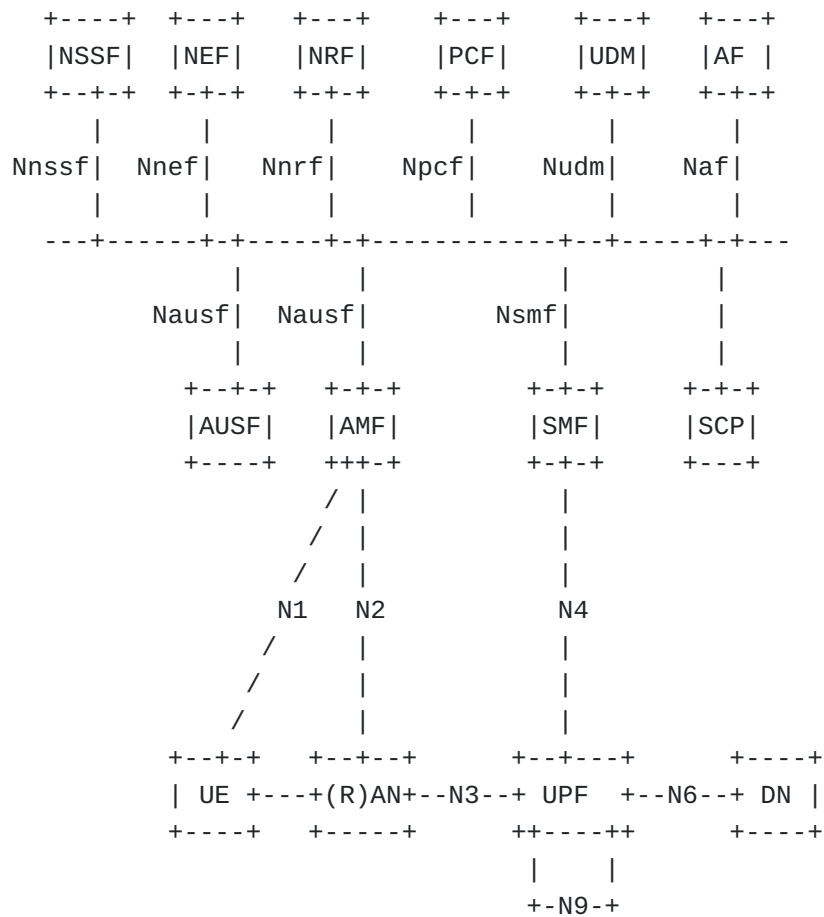

Figure 10: 5G System Architecture

To allow UE mobility across cells/gNBs, handover mechanisms are supported in NR. For an established connection, i.e., connected mode mobility, a gNB can configure a UE to report measurements of received signal strength and quality of its own and neighbouring cells, periodically or event-based. Based on these measurement reports, the gNB decides to handover a UE to another target cell/gNB. Before triggering the handover, it is hand-shaked with the target gNB based on network signalling. A handover command is then sent to the UE and the UE switches its connection to the target cell/gNB. The Packet Data Convergence Protocol (PDCP) of the UE can be configured to avoid data loss in this procedure, i.e., handle retransmissions if needed. Data forwarding is possible between source and target gNB as well. To improve the mobility performance further, i.e., to avoid connection failures, e.g., due to too-late handovers, the mechanism of conditional handover is introduced in Release 16 specifications. Therein a conditional handover command, defining a triggering point, can be sent to the UE before UE enters a handover situation. A further improvement that has been introduced in Release 16 is the Dual Active Protocol Stack (DAPS), where the UE maintains the connection to the source cell while connecting to the

target cell. This way, potential interruptions in packet delivery can be avoided entirely.

6.4.2. Overview of The Radio Protocol Stack

The protocol architecture for NR consists of the L1 Physical layer (PHY) and as part of the L2, the sublayers of Medium Access Control (MAC), Radio Link Control (RLC), Packet Data Convergence Protocol (PDCP), as well as the Service Data Adaptation Protocol (SDAP).

The PHY layer handles signal processing related actions, such as encoding/decoding of data and control bits, modulation, antenna precoding and mapping.

The MAC sub-layer handles multiplexing and priority handling of logical channels (associated with QoS flows) to transport blocks for PHY transmission, as well as scheduling information reporting and error correction through Hybrid Automated Repeat Request (HARQ).

The RLC sublayer handles sequence numbering of higher layer packets, retransmissions through Automated Repeat Request (ARQ), if configured, as well as segmentation and reassembly and duplicate detection.

The PDCP sublayer consists of functionalities for ciphering/deciphering, integrity protection/verification, re-ordering and in-order delivery, duplication and duplicate handling for higher layer packets, and acts as the anchor protocol to support handovers.

The SDAP sublayer provides services to map QoS flows, as established by the 5G core network, to data radio bearers (associated with logical channels), as used in the 5G RAN.

Additionally, in RAN, the Radio Resource Control (RRC) protocol, handles the access control and configuration signalling for the aforementioned protocol layers. RRC messages are considered L3 and thus transmitted also via those radio protocol layers.

To provide low latency and high reliability for one transmission link, i.e., to transport data (or control signaling) of one radio bearer via one carrier, several features have been introduced on the user plane protocols for PHY and L2, as explained in the following.

6.4.3. Radio (PHY)

NR is designed with native support of antenna arrays utilizing benefits from beamforming, transmissions over multiple MIMO layers and advanced receiver algorithms allowing effective interference cancellation. Those antenna techniques are the basis for high signal quality and effectiveness of spectral usage. Spatial diversity with

up to 4 MIMO layers in UL and up to 8 MIMO layers in DL is supported. Together with spatial-domain multiplexing, antenna arrays can focus power in desired direction to form beams. NR supports beam management mechanisms to find the best suitable beam for UE initially and when it is moving. In addition, gNBs can coordinate their respective DL and UL transmissions over the backhaul network keeping interference reasonably low, and even make transmissions or receptions from multiple points (multi-TRP). Multi-TRP can be used for repetition of data packet in time, in frequency or over multiple MIMO layers which can improve reliability even further.

Any downlink transmission to a UE starts from resource allocation signaling over the Physical Downlink Control Channel (PDCCH). If it is successfully received, the UE will know about the scheduled transmission and may receive data over the Physical Downlink Shared Channel (PDSCH). If retransmission is required according to the HARQ scheme, a signaling of negative acknowledgement (NACK) on the Physical Uplink Control Channel (PUCCH) is involved and PDCCH together with PDSCH transmissions (possibly with additional redundancy bits) are transmitted and soft-combined with previously received bits. Otherwise, if no valid control signaling for scheduling data is received, nothing is transmitted on PUCCH (discontinuous transmission - DTX), and the base station upon detecting DTX will retransmit the initial data.

An uplink transmission normally starts from a Scheduling Request (SR) - a signaling message from the UE to the base station sent via PUCCH. Once the scheduler is informed about buffer data in UE, e.g., by SR, the UE transmits a data packet on the Physical Uplink Shared Channel (PUSCH). Pre-scheduling not relying on SR is also possible (see following section).

Since transmission of data packets require usage of control and data channels, there are several methods to maintain the needed reliability. NR uses Low Density Parity Check (LDPC) codes for data channels, Polar codes for PDCCH, as well as orthogonal sequences and Polar codes for PUCCH. For ultra-reliability of data channels, very robust (low spectral efficiency) Modulation and Coding Scheme (MCS) tables are introduced containing very low (down to 1/20) LDPC code rates using BPSK or QPSK. Also, PDCCH and PUCCH channels support multiple code rates including very low ones for the channel robustness.

A connected UE reports downlink (DL) quality to gNB by sending Channel State Information (CSI) reports via PUCCH while uplink (UL) quality is measured directly at gNB. For both uplink and downlink, gNB selects the desired MCS number and signals it to the UE by Downlink Control Information (DCI) via PDCCH channel. For URLLC services, the UE can assist the gNB by advising that MCS targeting

10^{-5} Block Error Rate (BLER) are used. Robust link adaptation algorithms can maintain the needed level of reliability considering a given latency bound.

Low latency on the physical layer is provided by short transmission duration which is possible by using high Subcarrier Spacing (SCS) and the allocation of only one or a few Orthogonal Frequency Division Multiplexing (OFDM) symbols. For example, the shortest latency for the worst case in DL can be 0.23ms and in UL can be 0.24ms according to (section 5.7.1 in [TR37910]). Moreover, if the initial transmission has failed, HARQ feedback can quickly be provided and an HARQ retransmission is scheduled.

Dynamic multiplexing of data associated with different services is highly desirable for efficient use of system resources and to maximize system capacity. Assignment of resources for eMBB is usually done with regular (longer) transmission slots, which can lead to blocking of low latency services. To overcome the blocking, eMBB resources can be pre-empted and re-assigned to URLLC services. In this way, spectrally efficient assignments for eMBB can be ensured while providing flexibility required to ensure a bounded latency for URLLC services. In downlink, the gNB can notify the eMBB UE about pre-emption after it has happened, while in uplink there are two pre-emption mechanisms: special signaling to cancel eMBB transmission and URLLC dynamic power boost to suppress eMBB transmission.

6.4.4. Scheduling and QoS (MAC)

One integral part of the 5G system is the Quality of Service (QoS) framework [TS23501]. QoS flows are setup by the 5G system for certain IP or Ethernet packet flows, so that packets of each flow receive the same forwarding treatment, i.e., in scheduling and admission control. QoS flows can for example be associated with different priority level, packet delay budgets and tolerable packet error rates. Since radio resources are centrally scheduled in NR, the admission control function can ensure that only those QoS flows are admitted for which QoS targets can be reached.

NR transmissions in both UL and DL are scheduled by the gNB [TS38300]. This ensures radio resource efficiency, fairness in resource usage of the users and enables differentiated treatment of the data flows of the users according to the QoS targets of the flows. Those QoS flows are handled as data radio bearers or logical channels in NR RAN scheduling.

The gNB can dynamically assign DL and UL radio resources to users, indicating the resources as DL assignments or UL grants via control channel to the UE. Radio resources are defined as blocks of OFDM

symbols in spectral domain and time domain. Different lengths are supported in time domain, i.e., (multiple) slot or mini-slot lengths. Resources of multiple frequency carriers can be aggregated and jointly scheduled to the UE.

Scheduling decisions are based, e.g., on channel quality measured on reference signals and reported by the UE (cf. periodical CSI reports for DL channel quality). The transmission reliability can be chosen in the scheduling algorithm, i.e., by link adaptation where an appropriate transmission format (e.g., robustness of modulation and coding scheme, controlled UL power) is selected for the radio channel condition of the UE. Retransmissions, based on HARQ feedback, are also controlled by the scheduler. The feedback transmission in HARQ loop introduces delays, but there are methods to minimize it by using short transmission formats, sub-slot feedback reporting and PUCCH carrier switching. If needed to avoid HARQ round-trip time delays, repeated transmissions can be also scheduled beforehand, to the cost of reduced spectral efficiency.

In dynamic DL scheduling, transmission can be initiated immediately when DL data becomes available in the gNB. However, for dynamic UL scheduling, when data becomes available but no UL resources are available yet, the UE indicates the need for UL resources to the gNB via a (single bit) scheduling request message in the UL control channel. When thereupon UL resources are scheduled to the UE, the UE can transmit its data and may include a buffer status report, indicating the exact amount of data per logical channel still left to be sent. More UL resources may be scheduled accordingly. To avoid the latency introduced in the scheduling request loop, UL radio resources can also be pre-scheduled.

In particular for periodical traffic patterns, the pre-scheduling can rely on the scheduling features DL Semi-Persistent Scheduling (SPS) and UL Configured Grant (CG). With these features, periodically recurring resources can be assigned in DL and UL. Multiple parallels of those configurations are supported, in order to serve multiple parallel traffic flows of the same UE.

To support QoS enforcement in the case of mixed traffic with different QoS requirements, several features have recently been introduced. This way, e.g., different periodical critical QoS flows can be served together with best effort transmissions, by the same UE. Among others, these features (partly Release 16) are: 1) UL logical channel transmission restrictions allowing to map logical channels of certain QoS only to intended UL resources of a certain frequency carrier, slot-length, or CG configuration, and 2) intra-UE pre-emption and multiplexing, allowing critical UL transmissions to either pre-empt non-critical transmissions or being multiplexed with non-critical transmissions keeping different reliability targets.

When multiple frequency carriers are aggregated, duplicate parallel transmissions can be employed (beside repeated transmissions on one carrier). This is possible in the Carrier Aggregation (CA) architecture where those carriers originate from the same gNB, or in the Dual Connectivity (DC) architecture where the carriers originate from different gNBs, i.e., the UE is connected to two gNBs in this case. In both cases, transmission reliability is improved by this means of providing frequency diversity.

In addition to licensed spectrum, a 5G system can also utilize unlicensed spectrum to offload non-critical traffic. This version of NR is called NR-U, part of 3GPP Release 16. The central scheduling approach applies also for unlicensed radio resources, but in addition also the mandatory channel access mechanisms for unlicensed spectrum, e.g., Listen Before Talk (LBT) are supported in NR-U. This way, by using NR, operators have and can control access to both licensed and unlicensed frequency resources.

6.4.5. Time-Sensitive Communications (TSC)

Recent 3GPP releases have introduced various features to support multiple aspects of Time-Sensitive Communication ((TSC), which includes Time-Sensitive Networking (TSN) and beyond as described in this section.

The main objective of Time-Sensitive Networking (TSN) is to provide guaranteed data delivery within a guaranteed time window, i.e., bounded low latency. IEEE 802.1 TSN [[IEEE802.1TSN](#)] is a set of open standards that provide features to enable deterministic communication on standard IEEE 802.3 Ethernet [[IEEE802.3](#)]. TSN standards can be seen as a toolbox for traffic shaping, resource management, time synchronization, and reliability.

A TSN stream is a data flow between one end station (Talker) to another end station (Listener). In the centralized configuration model, TSN bridges are configured by the Central Network Controller (CNC) [[IEEE802.1Qcc](#)] to provide deterministic connectivity for the TSN stream through the network. Time-based traffic shaping provided by Scheduled Traffic [[IEEE802.1Qbv](#)] may be used to achieve bounded low latency. The TSN tool for time synchronization is the generalized Precision Time Protocol (gPTP) [[IEEE802.1AS](#)], which provides reliable time synchronization that can be used by end stations and by other TSN tools, e.g., Scheduled Traffic [[IEEE802.1Qbv](#)]. High availability, as a result of ultra-reliability, is provided for data flows by the Frame Replication and Elimination for Reliability (FRER) [[IEEE802.1CB](#)] mechanism.

3GPP Release 16 includes integration of 5G with TSN, i.e., specifies functions for the 5G System (5GS) to deliver TSN streams such that

the meet their QoS requirements. A key aspect of the integration is the 5GS appears from the rest of the network as a set of TSN bridges, in particular, one virtual bridge per User Plane Function (UPF) on the user plane. The 5GS includes TSN Translator (TT) functionality for the adaptation of the 5GS to the TSN bridged network and for hiding the 5GS internal procedures. The 5GS provides the following components:

1. interface to TSN controller, as per [[IEEE802.1Qcc](#)] for the fully centralized configuration model
2. time synchronization via reception and transmission of gPTP PDUs [[IEEE802.1AS](#)]
3. low latency, hence, can be integrated with Scheduled Traffic [[IEEE802.1Qbv](#)]
4. reliability, hence, can be integrated with FRER [[IEEE802.1CB](#)]

3GPP Release 17 [[TS23501](#)] introduced enhancements to generalize support for Time-Sensitive Communications (TSC) beyond TSN. This includes IP communications to provide time-sensitive service to, e.g., Video, Imaging and Audio for Professional Applications (VIAPA). The system model of 5G acting as a "TSN bridge" in Release 16 has been reused to enable the 5GS acting as a "TSC node" in a more generic sense (which includes TSN bridge and IP node). In the case of TSC that does not involve TSN, requirements are given via exposure interface and the control plane provides the service based on QoS and time synchronization requests from an Application Function (AF).

[Figure 10](#) shows an illustration of 5G-TSN integration where an industrial controller (Ind Ctrlr) is connected to industrial Input/Output devices (I/O dev) via 5G. The 5GS can directly transport Ethernet frames since Release 15, thus, end-to-end Ethernet connectivity is provided. The 5GS implements the required interfaces towards the TSN controller functions such as the CNC, thus adapts to the settings of the TSN network. A 5G user plane virtual bridge interconnects TSN bridges or connect end stations, e.g., I/O devices to the network. Note that the introduction of 5G brings flexibility in various aspects, e.g., more flexible network topology because a wireless hop can replace several wireline hops thus significantly reduce the number of hops end-to-end. [[TSN5G](#)] dives more into the integration of 5G with TSN.

deployment, including connected TSN bridges and end stations. Release 17 includes further improvements, i.e., methods for propagation delay compensation in RAN, further improving the accuracy for time synchronization over-the-air, as well as the possibility for the TSN grandmaster clock to reside on the UE side. More extensions and flexibility were added to the time synchronization service making it general for TSN with additional support of other types of clocks and time distribution such as boundary clock, transparent clock peer-to-peer, transparent clock end-to-end, aside from the time-aware system used for TSN. Additionally, it is possible to use internal access stratum signaling to distribute timing (and not the usual (g)PTP messages), for which the required accuracy can be provided by the AF [[TS23501](#)]. The same time synchronization service is expected to be further extended and enhanced in Release 18 to support Timing Resiliency (according to study item [[SP211634](#)]), where the 5G system can provide a back-up or alternative timing source for the failure of the local GNSS source (or other primary timing source) used by the vertical.

IETF Deterministic Networking (DetNet) is the technology to support time-sensitive communications at the IP layer. 3GPP Release 18 includes a study [[TR2370046](#)] on interworking between 5G and DetNet. Along the TSN framework introduced for Release 17, the 5GS acts as a DetNet node for the support of DetNet, see Figure 7.1-1 in [[TR2370046](#)]. The study provides details on how the 5GS is exposed by the Time Sensitive Communication and Time Synchronization Function (TSCTSF) to the DetNet controller as a router on a per UPF granularity (similarly to the per UPF Virtual TSN Bridge granularity shown in Figure 11). In particular, it is listed what parameters are provided by the TSCTSF to the DetNet controller. The study also includes how the TSCTSF maps DetNet flow parameters to 5G QoS parameters. Note that TSN is the primary subnetwork technology for DetNet. Thus, the DetNet over TSN work, e.g., [[RFC9023](#)], can be leveraged via the TSN support built in 5G. As the standards are ready for such an approach, it is out of scope for the 3GPP Release 18 study item [[TR2370046](#)].

Redundancy architectures were specified in order to provide reliability against any kind of failure on the radio link or nodes in the RAN and the core network, Redundant user plane paths can be provided based on the dual connectivity architecture, where the UE sets up two PDU sessions towards the same data network, and the 5G system makes the paths of the two PDU sessions independent as illustrated in [Figure 13](#). There are two PDU sessions involved in the solution: the first spans from the UE via gNB1 to UPF1, acting as the first PDU session anchor, while the second spans from the UE via gNB2 to UPF2, acting as second the PDU session anchor. The independent paths may continue beyond the 3GPP network. Redundancy

Handling Functions (RHF) are deployed outside of the 5GS, i.e., in Host A (the device) and in Host B (the network). RHF can implement replication and elimination functions as per [IEEE802.1CB] or the Packet Replication, Elimination, and Ordering Functions (PREOF) of IETF Deterministic Networking (DetNet) [RFC8655].

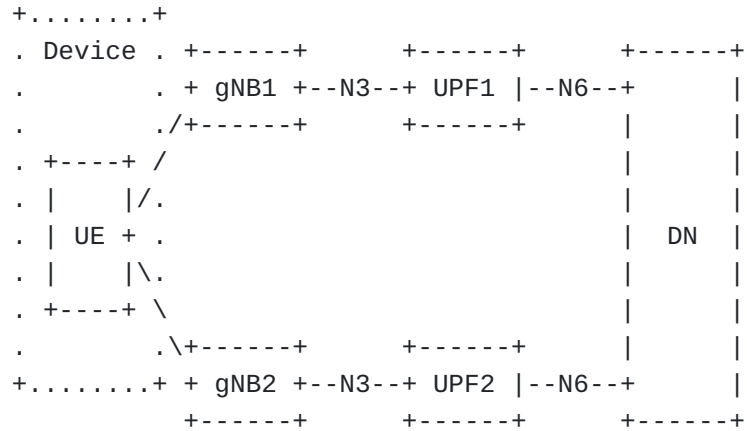

Figure 12: Reliability with Single UE

An alternative solution is that multiple UEs per device are used for user plane redundancy as illustrated in Figure 13. Each UE sets up a PDU session. The 5GS ensures that those PDU sessions of the different UEs are handled independently internal to the 5GS. There is no single point of failure in this solution, which also includes RHF outside of the 5G system, e.g., as per FRER or as PREOF specifications.

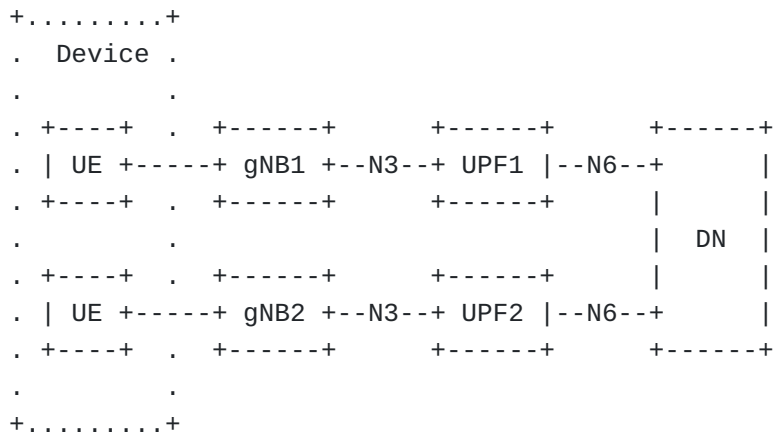

Figure 13: Reliability with Dual UE

Note that the abstraction provided by the RHF and the location of the RHF being outside of the 5G system make 5G equally supporting integration for reliability both with FRER of TSN and PREOF of DetNet as they both rely on the same concept.

6.5. Summary

5G technology enables deterministic communication. Based on the centralized admission control and the scheduling of the wireless resources, licensed or unlicensed, quality of service such as latency and reliability can be guaranteed. 5G contains several features to achieve ultra-reliable and low latency performance, e.g., support for different OFDM numerologies and slot-durations, as well as fast processing capabilities and redundancy techniques that lead to achievable latency numbers of below 1ms with 99.999% or higher confidence.

5G also includes features to support Industrial IoT use cases, e.g., via the integration of 5G with TSN. This includes 5G capabilities for each TSN component, latency, resource management, time synchronization, and reliability. Furthermore, 5G support for TSN can be leveraged when 5G is used as subnet technology for DetNet, in combination with or instead of TSN, which is the primary subnet for DetNet. In addition, the support for integration with TSN reliability was added to 5G by making DetNet reliability also applicable, thus making 5G DetNet ready. Moreover, providing IP service is native to 5G and adding direct support for DetNet is in scope of the upcoming 3GPP Release 18.

Overall, 5G provides scheduled wireless segments with high reliability and availability. In addition, 5G includes capabilities for integration to IP networks.

7. L-band Digital Aeronautical Communications System

One of the main pillars of the modern Air Traffic Management (ATM) system is the existence of a communication infrastructure that enables efficient aircraft guidance and safe separation in all phases of flight. Although current systems are technically mature, they are suffering from the VHF band's increasing saturation in high-density areas and the limitations posed by analogue radio. Therefore, aviation globally and the European Union (EU) in particular, strives for a sustainable modernization of the aeronautical communication infrastructure.

In the long-term, ATM communication shall transition from analogue VHF voice and VDL2 communication to more spectrum efficient digital data communication. The European ATM Master Plan foresees this transition to be realized for terrestrial communications by the development and implementation of the L-band Digital Aeronautical Communications System (LDACS). LDACS shall enable IPv6 based air-ground communication related to the safety and regularity of the flight. The particular challenge is that no new frequencies can be made available for terrestrial aeronautical communication. It was

thus necessary to develop procedures to enable the operation of LDACS in parallel with other services in the same frequency band.

7.1. Provenance and Documents

The development of LDACS has already made substantial progress in the Single European Sky ATM Research (SESAR) framework, and is currently being continued in the follow-up program, SESAR2020 [RIH18]. A key objective of the SESAR activities is to develop, implement and validate a modern aeronautical data link able to evolve with aviation needs over long-term. To this end, an LDACS specification has been produced [GRA19] and is continuously updated; transmitter demonstrators were developed to test the spectrum compatibility of LDACS with legacy systems operating in the L-band [SAJ14]; and the overall system performance was analyzed by computer simulations, indicating that LDACS can fulfill the identified requirements [GRA11].

LDACS standardization within the framework of the International Civil Aviation Organization (ICAO) started in December 2016. The ICAO standardization group has produced an initial Standards and Recommended Practices (SARPs) document [ICA018]. The SARPs document defines the general characteristics of LDACS. The ICAO standardization group plans to produce an ICAO technical manual - the ICAO equivalent to a technical standard - within the next years. Generally, the group is open to input from all sources and develops LDACS in the open.

Up to now the LDACS standardization has been focused on the development of the physical layer and the data link layer, only recently have higher layers come into the focus of the LDACS development activities. There is currently no "IPv6 over LDACS" specification; however, SESAR2020 has started the testing of IPv6-based LDACS testbeds. The IPv6 architecture for the aeronautical telecommunication network is called the Future Communications Infrastructure (FCI). FCI shall support quality of service, diversity, and mobility under the umbrella of the "multi-link concept". This work is conducted by ICAO working group WG-I.

In addition to standardization activities several industrial LDACS prototypes have been built. One set of LDACS prototypes has been evaluated in flight trials confirming the theoretical results predicting the system performance [GRA18][SCH19].

7.2. General Characteristics

LDACS will become one of several wireless access networks connecting aircraft to the Aeronautical Telecommunications Network (ATN). The LDACS access network contains several ground stations, each of them

providing one LDACS radio cell. The LDACS air interface is a cellular data link with a star-topology connecting aircraft to ground-stations with a full duplex radio link. Each ground-station is the centralized instance controlling all air-ground communications within its radio cell.

The user data rate of LDACS is 315 kbit/s to 1428 kbit/s on the forward link, and 294 kbit/s to 1390 kbit/s on the reverse link, depending on coding and modulation. Due to strong interference from legacy systems in the L-band, the most robust coding and modulation SHOULD be expected for initial deployment i.e. 315/294 kbit/s on the forward/reverse link, respectively.

In addition to the communications capability, LDACS also offers a navigation capability. Ranging data, similar to DME (Distance Measuring Equipment), is extracted from the LDACS communication links between aircraft and LDACS ground stations. This results in LDACS providing an APNT (Alternative Position, Navigation and Timing) capability to supplement the existing on-board GNSS (Global Navigation Satellite System) without the need for additional bandwidth. Operationally, there will be no difference for pilots whether the navigation data are provided by LDACS or DME. This capability was flight tested and proven during the MICONAV flight trials in 2019 [[BAT19](#)].

In previous works and during the MICONAV flight campaign in 2019, it was also shown, that LDACS can be used for surveillance capability. Filip et al. [[FIL19](#)] shown passive radar capabilities of LDACS and Automatic Dependence Surveillance - Contract (ADS-C) was demonstrated via LDACS during the flight campaign 2019 [[SCH19](#)].

Since LDACS has been mainly designed for air traffic management communication it supports mutual entity authentication, integrity and confidentiality capabilities of user data messages and some control channel protection capabilities [[MAE18](#)], [[MAE191](#)], [[MAE192](#)], [[MAE20](#)].

Overall this makes LDACS the world's first truly integrated CNS system and is the worldwide most mature, secure, terrestrial long-range CNS technology for civil aviation.

7.3. Deployment and Spectrum

LDACS has its origin in merging parts of the B-VHF [[BRA06](#)], B-AMC [[SCH08](#)], TIA-902 (P34) [[HAI09](#)], and WiMAX IEEE 802.16e technologies [[EHA11](#)]. In 2007 the spectrum for LDACS was allocated at the World Radio Conference (WRC).

It was decided to allocate the spectrum next to Distance Measuring Equipment (DME), resulting in an in-lay approach between the DME channels for LDAC [[SCH14](#)].

LDACS is currently being standardized by ICAO and several roll-out strategies are discussed:

The LDACS data link provides enhanced capabilities to existing Aeronautical communications infrastructure enabling them to better support user needs and new applications. The deployment scalability of LDACS allows its implementation to start in areas where most needed to improve immediately the performance of already fielded infrastructure. Later the deployment is extended based on operational demand. An attractive scenario for upgrading the existing VHF communication systems by adding an additional LDACS data link is described below.

When considering the current VDL Mode 2 infrastructure and user base, a very attractive win-win situation comes about, when the technological advantages of LDACS are combined with the existing VDL mode 2 infrastructure. LDACS provides at least 50 times more capacity than VDL Mode 2 and is a natural enhancement to the existing VDL Mode 2 business model. The advantage of this approach is that the VDL Mode 2 infrastructure can be fully reused. Beyond that, it opens the way for further enhancements which can increase business efficiency and minimize investment risk. [[ICA019](#)]

7.4. Applicability to Deterministic Flows

As LDACS is a ground-based digital communications system for flight guidance and communications related to safety and regularity of flight, time-bounded deterministic arrival times for safety critical messages are a key feature for its successful deployment and roll-out.

7.4.1. System Architecture

Up to 512 Aircraft Station (AS) communicate to an LDACS Ground Station (GS) in the Reverse Link (RL). GS communicate to AS in the Forward Link (FL). Via an Access-Router (AC-R) GSs connect the LDACS sub-network to the global Aeronautical Telecommunications Network (ATN) to which the corresponding Air Traffic Services (ATS) and Aeronautical Operational Control (AOC) end systems are attached.

7.4.2. Overview of The Radio Protocol Stack

The protocol stack of LDACS is implemented in the AS and GS: It consists of the Physical Layer (PHY) with five major functional blocks above it. Four are placed in the Data Link Layer (DLL) of the AS and GS: (1) Medium Access Layer (MAC), (2) Voice Interface (VI),

(3) Data Link Service (DLS), and (4) LDACS Management Entity (LME). The last entity resides within the Sub-Network Layer: Sub-Network Protocol (SNP). The LDACS network is externally connected to voice units, radio control units, and the ATN Network Layer.

Figure 14 shows the protocol stack of LDACS as implemented in the AS and GS.

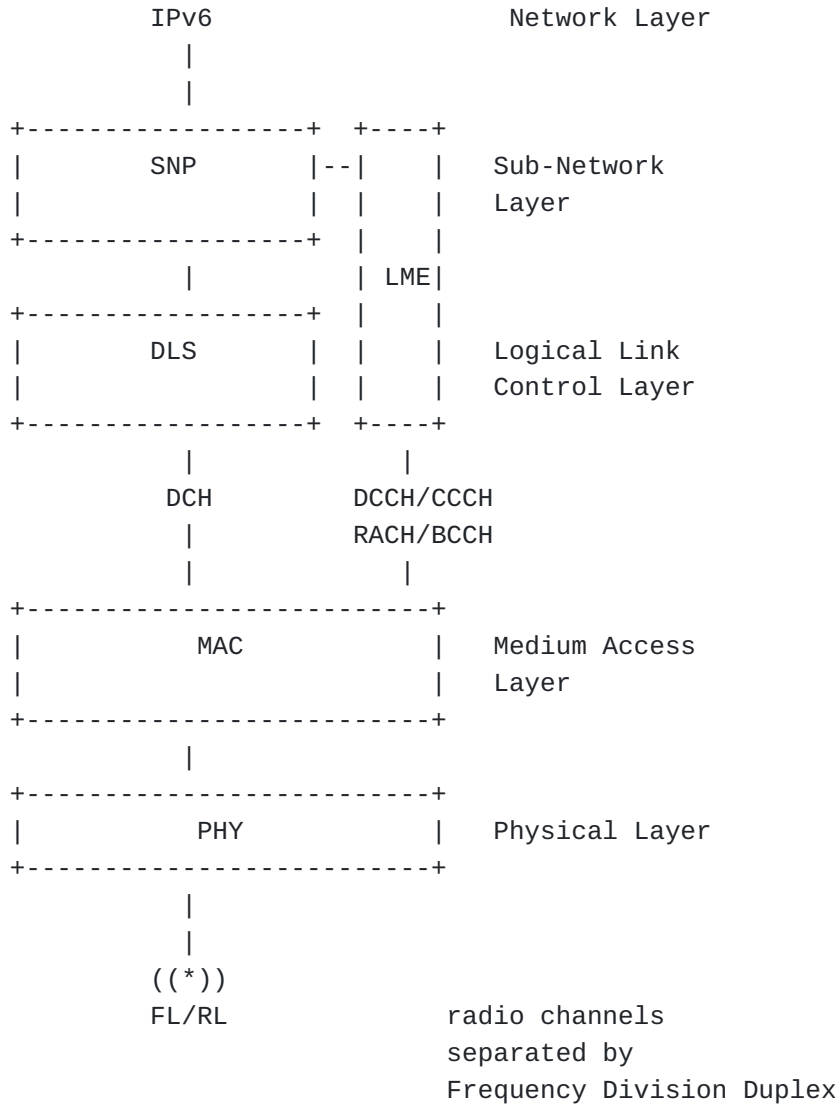

Figure 14: LDACS protocol stack in AS and GS

7.4.3. Radio (PHY)

The physical layer provides the means to transfer data over the radio channel. The LDACS ground-station supports bi-directional

links to multiple aircraft under its control. The forward link direction (FL; ground-to-air) and the reverse link direction (RL; air-to-ground) are separated by frequency division duplex. Forward link and reverse link use a 500 kHz channel each. The ground-station transmits a continuous stream of OFDM symbols on the forward link. In the reverse link different aircraft are separated in time and frequency using a combination of Orthogonal Frequency-Division Multiple-Access (OFDMA) and Time-Division Multiple-Access (TDMA). Aircraft thus transmit discontinuously on the reverse link with radio bursts sent in precisely defined transmission opportunities allocated by the ground-station. The most important service on the PHY layer of LDACS is the PHY time framing service, which indicates that the PHY layer is ready to transmit in a given slot and to indicate PHY layer framing and timing to the MAC time framing service. LDACS does not support beam-forming or Multiple Input Multiple Output (MIMO).

7.4.4. Scheduling, Frame Structure and QoS (MAC)

The data-link layer provides the necessary protocols to facilitate concurrent and reliable data transfer for multiple users. The LDACS data link layer is organized in two sub-layers: The medium access sub-layer and the logical link control sub-layer. The medium access sub-layer manages the organization of transmission opportunities in slots of time and frequency. The logical link control sub-layer provides acknowledged point-to-point logical channels between the aircraft and the ground-station using an automatic repeat request protocol. LDACS supports also unacknowledged point-to-point channels and ground-to-air broadcast. Before going more into depth about the LDACS medium access, the frame structure of LDACS is introduced:

The LDACS framing structure for FL and RL is based on Super-Frames (SF) of 240 ms duration. Each SF corresponds to 2000 OFDM symbols. The FL and RL SF boundaries are aligned in time (from the view of the GS).

In the FL, an SF contains a Broadcast Frame of duration 6.72 ms (56 OFDM symbols) for the Broadcast Control Channel (BCCH), and four Multi-Frames (MF), each of duration 58.32 ms (486 OFDM symbols).

In the RL, each SF starts with a Random Access (RA) slot of length 6.72 ms with two opportunities for sending RL random access frames for the Random Access Channel (RACH), followed by four MFs. These MFs have the same fixed duration of 58.32 ms as in the FL, but a different internal structure

[Figure 15](#) and [Figure 16](#) illustrate the LDACS frame structure.

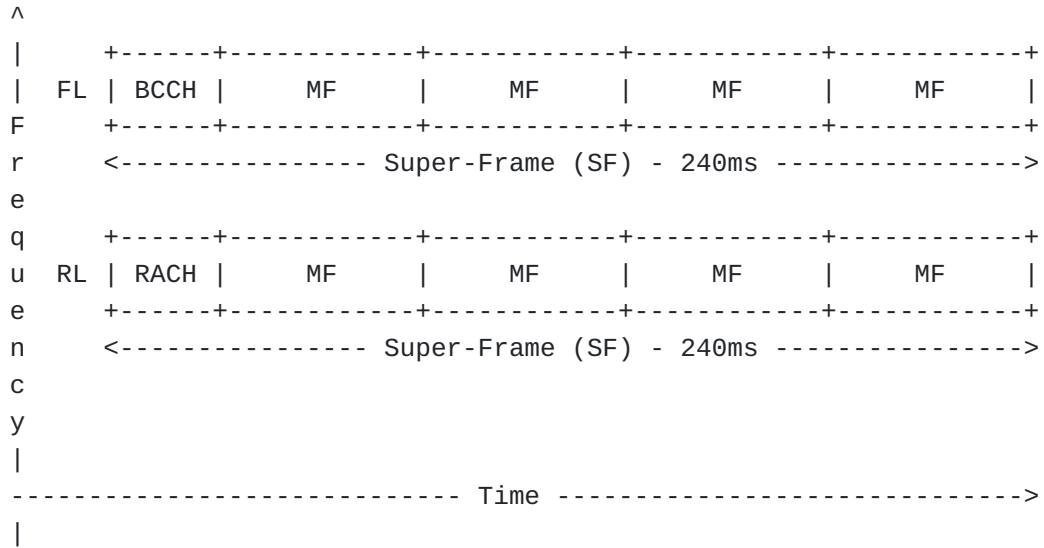

Figure 15: SF structure for LDACS

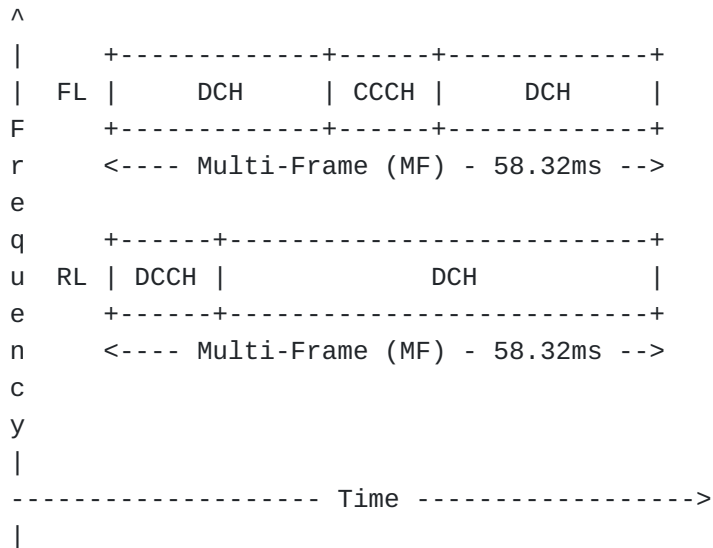

Figure 16: MF structure for LDACS

This fixed frame structure allows for a reliable and dependable transmission of data. Next, the LDACS medium access layer is introduced:

LDACS medium access is always under the control of the ground-station of a radio cell. Any medium access for the transmission of user data has to be requested with a resource request message stating the requested amount of resources and class of service. The ground-station performs resource scheduling on the basis of these

requests and grants resources with resource allocation messages. Resource request and allocation messages are exchanged over dedicated contention-free control channels.

LDACS has two mechanisms to request resources from the scheduler in the ground-station. Resources can either be requested "on demand" with a given class of service. On the forward link, this is done locally in the ground-station, on the reverse link a dedicated contention-free control channel is used (Dedicated Control Channel (DCCH); roughly 83 bit every 60 ms). A resource allocation is always announced in the control channel of the forward link (Common Control Channel (CCCH); variable sized). Due to the spacing of the reverse link control channels of every 60 ms, a medium access delay in the same order of magnitude is to be expected.

Resources can also be requested "permanently". The permanent resource request mechanism supports requesting recurring resources in given time intervals. A permanent resource request has to be canceled by the user (or by the ground-station, which is always in control). User data transmissions over LDACS are therefore always scheduled by the ground-station, while control data uses statically (i.e. at net entry) allocated recurring resources (DCCH and CCCH). The current specification documents specify no scheduling algorithm. However performance evaluations so far have used strict priority scheduling and round robin for equal priorities for simplicity. In the current prototype implementations LDACS classes of service are thus realized as priorities of medium access and not as flows. Note that this can starve out low priority flows. However, this is not seen as a big problem since safety related message always go first in any case. Scheduling of reverse link resources is done in physical Protocol Data Units (PDU) of 112 bit (or larger if more aggressive coding and modulation is used). Scheduling on the forward link is done Byte-wise since the forward link is transmitted continuously by the ground-station.

In order to support diversity, LDACS supports handovers to other ground-stations on different channels. Handovers may be initiated by the aircraft (break-before-make) or by the ground-station (make-before-break). Beyond this, FCI diversity shall be implemented by the multi-link concept.

7.5. Summary

LDACS has been designed with applications related to the safety and regularity of the flight in mind. It has therefore been designed as a deterministic wireless data link (as far as possible).

It is a secure, scalable and spectrum efficient data link with embedded navigation capability and thus, is the first truly

integrated CNS system recognized by ICAO. During flight tests the LDACS capabilities have been successfully demonstrated. A viable roll-out scenario has been developed which allows gradual introduction of LDACS with immediate use and revenues. Finally, ICAO is developing LDACS standards to pave the way for a successful roll-out in the near future.

8. IANA Considerations

This specification does not require IANA action.

9. Security Considerations

Most RAW technologies integrate some authentication or encryption mechanisms that were defined outside the IETF.

10. Contributors

This document aggregates articles from authors specialized in each technologies. Beyond the main authors listed in the front page, the following contributors proposed additional text and refinement that improved the document greatly!

Georgios Z. Papadopoulos: Contributed to the TSCH section.

Nils Maeurer: Contributed to the LDACS section.

Thomas Graeupl: Contributed to the LDACS section.

Torsten Dudda, Alexey Shapin, and Sara Sandberg: Contributed to the 5G section.

Rocco Di Taranto: Contributed to the Wi-Fi section

Rute Sofia: Contributed to the Introduction and Terminology sections

11. Acknowledgments

Many thanks to the participants of the RAW WG where a lot of the work discussed here happened, and Malcolm Smith for his review of the 802.11 section.

12. Normative References

[RFC5673] Pister, K., Ed., Thubert, P., Ed., Dwars, S., and T. Phinney, "Industrial Routing Requirements in Low-Power and Lossy Networks", RFC 5673, DOI 10.17487/RFC5673, October 2009, <<https://www.rfc-editor.org/info/rfc5673>>.

- [RFC8200] Deering, S. and R. Hinden, "Internet Protocol, Version 6 (IPv6) Specification", STD 86, RFC 8200, DOI 10.17487/RFC8200, July 2017, <<https://www.rfc-editor.org/info/rfc8200>>.
- [RFC8557] Finn, N. and P. Thubert, "Deterministic Networking Problem Statement", RFC 8557, DOI 10.17487/RFC8557, May 2019, <<https://www.rfc-editor.org/info/rfc8557>>.
- [RFC8655] Finn, N., Thubert, P., Varga, B., and J. Farkas, "Deterministic Networking Architecture", RFC 8655, DOI 10.17487/RFC8655, October 2019, <<https://www.rfc-editor.org/info/rfc8655>>.
- [RFC9030] Thubert, P., Ed., "An Architecture for IPv6 over the Time-Slotted Channel Hopping Mode of IEEE 802.15.4 (6TiSCH)", RFC 9030, DOI 10.17487/RFC9030, May 2021, <<https://www.rfc-editor.org/info/rfc9030>>.

13. Informative References

- [RFC8480] Wang, Q., Ed., Vilajosana, X., and T. Watteyne, "6TiSCH Operation Sublayer (6top) Protocol (6P)", RFC 8480, DOI 10.17487/RFC8480, November 2018, <<https://www.rfc-editor.org/info/rfc8480>>.
- [RFC8938] Varga, B., Ed., Farkas, J., Berger, L., Malis, A., and S. Bryant, "Deterministic Networking (DetNet) Data Plane Framework", RFC 8938, DOI 10.17487/RFC8938, November 2020, <<https://www.rfc-editor.org/info/rfc8938>>.
- [RFC9033] Chang, T., Ed., Vučinić, M., Vilajosana, X., Duquennoy, S., and D. Dujovne, "6TiSCH Minimal Scheduling Function (MSF)", RFC 9033, DOI 10.17487/RFC9033, May 2021, <<https://www.rfc-editor.org/info/rfc9033>>.
- [RFC6550] Winter, T., Ed., Thubert, P., Ed., Brandt, A., Hui, J., Kelsey, R., Levis, P., Pister, K., Struik, R., Vasseur, JP., and R. Alexander, "RPL: IPv6 Routing Protocol for Low-Power and Lossy Networks", RFC 6550, DOI 10.17487/RFC6550, March 2012, <<https://www.rfc-editor.org/info/rfc6550>>.
- [RFC6551] Vasseur, JP., Ed., Kim, M., Ed., Pister, K., Dejean, N., and D. Barthel, "Routing Metrics Used for Path Calculation in Low-Power and Lossy Networks", RFC 6551, DOI 10.17487/RFC6551, March 2012, <<https://www.rfc-editor.org/info/rfc6551>>.

[RFC6291]

Andersson, L., van Helvoort, H., Bonica, R., Romascanu, D., and S. Mansfield, "Guidelines for the Use of the "OAM" Acronym in the IETF", BCP 161, RFC 6291, DOI 10.17487/RFC6291, June 2011, <<https://www.rfc-editor.org/info/rfc6291>>.

[RFC7276]

Mizrahi, T., Sprecher, N., Bellagamba, E., and Y. Weingarten, "An Overview of Operations, Administration, and Maintenance (OAM) Tools", RFC 7276, DOI 10.17487/RFC7276, June 2014, <<https://www.rfc-editor.org/info/rfc7276>>.

[RFC8279]

Wijnands, IJ., Ed., Rosen, E., Ed., Dolganow, A., Przygienda, T., and S. Aldrin, "Multicast Using Bit Index Explicit Replication (BIER)", RFC 8279, DOI 10.17487/RFC8279, November 2017, <<https://www.rfc-editor.org/info/rfc8279>>.

[RFC9023]

Varga, B., Ed., Farkas, J., Malis, A., and S. Bryant, "Deterministic Networking (DetNet) Data Plane: IP over IEEE 802.1 Time-Sensitive Networking (TSN)", RFC 9023, DOI 10.17487/RFC9023, June 2021, <<https://www.rfc-editor.org/info/rfc9023>>.

[I-D.ietf-raw-architecture]

Thubert, P., "Reliable and Available Wireless Architecture", Work in Progress, Internet-Draft, draft-ietf-raw-architecture-10, 14 November 2022, <<https://www.ietf.org/archive/id/draft-ietf-raw-architecture-10.txt>>.

[I-D.ietf-roll-nsa-extension]

Koutsiamanis, R., Papadopoulos, G. Z., Montavont, N., and P. Thubert, "Common Ancestor Objective Function and Parent Set DAG Metric Container Extension", Work in Progress, Internet-Draft, draft-ietf-roll-nsa-extension-10, 29 October 2020, <<https://www.ietf.org/archive/id/draft-ietf-roll-nsa-extension-10.txt>>.

[I-D.papadopoulos-paw-pre-reqs]

Papadopoulos, G. Z., Koutsiamanis, R., Montavont, N., and P. Thubert, "Exploiting Packet Replication and Elimination in Complex Tracks in LLNs", Work in Progress, Internet-Draft, draft-papadopoulos-paw-pre-reqs-01, 25

March 2019, <<https://www.ietf.org/archive/id/draft-papadopoulos-paw-pre-reqs-01.txt>>.

[I-D.thubert-bier-replication-elimination]

Thubert, P., Eckert, T. T., Brodard, Z., and H. Jiang, "BIER-TE extensions for Packet Replication and Elimination Function (PREF) and OAM", Work in Progress, Internet-Draft, draft-thubert-bier-replication-elimination-03, 3 March 2018, <<https://www.ietf.org/archive/id/draft-thubert-bier-replication-elimination-03.txt>>.

[I-D.thubert-6lo-bier-dispatch] Thubert, P., Brodard, Z., Jiang, H., and G. Texier, "A 6loRH for BitStrings", Work in Progress, Internet-Draft, draft-thubert-6lo-bier-dispatch-06, 28 January 2019, <<https://www.ietf.org/archive/id/draft-thubert-6lo-bier-dispatch-06.txt>>.

[I-D.ietf-bier-te-arch] Eckert, T. T., Menth, M., and G. Cauchie, "Tree Engineering for Bit Index Explicit Replication (BIER-TE)", Work in Progress, Internet-Draft, draft-ietf-bier-te-arch-13, 25 April 2022, <<https://www.ietf.org/archive/id/draft-ietf-bier-te-arch-13.txt>>.

[I-D.ietf-6tisch-coap] Sudhaakar, R. S. and P. Zand, "6TiSCH Resource Management and Interaction using CoAP", Work in Progress, Internet-Draft, draft-ietf-6tisch-coap-03, 9 March 2015, <<https://www.ietf.org/archive/id/draft-ietf-6tisch-coap-03.txt>>.

[IEEE Std 802.15.4] IEEE standard for Information Technology, "IEEE Std 802.15.4, Part. 15.4: Wireless Medium Access Control (MAC) and Physical Layer (PHY) Specifications for Low-Rate Wireless Personal Area Networks".

[IEEE Std 802.11] IEEE standard for Information Technology, "IEEE Standard 802.11 - IEEE Standard for Information Technology - Telecommunications and information exchange between systems Local and metropolitan area networks - Specific requirements - Part 11: Wireless LAN Medium Access Control (MAC) and Physical Layer (PHY) Specifications.", <<https://ieeexplore.ieee.org/document/9363693>>.

[IEEE Std 802.11ax] IEEE standard for Information Technology, "802.11ax: Enhancements for High Efficiency WLAN", 2021, <<https://ieeexplore.ieee.org/document/9442429>>.

[IEEE Std 802.11ay] IEEE standard for Information Technology, "802.11ay: Enhanced throughput for operation in license-

exempt bands above 45 GHz", 2021, <<https://ieeexplore.ieee.org/document/9502046/>>.

[**IEEE Std 802.11ad**] "802.11ad: Enhancements for very high throughput in the 60 GHz band", 2012, <<https://ieeexplore.ieee.org/document/6392842/>>.

[**IEEE 802.11be WIP**] IEEE standard for Information Technology, "802.11be: Extreme High Throughput PAR", <<https://mentor.ieee.org/802.11/dcn/18/11-18-1231-04-0eht-eh-draft-proposed-par.docx>>.

[**IEEE Std 802.1Qat**] "802.1Qat: Stream Reservation Protocol".

[**Cavalcanti_2019**] Dave Cavalcanti et al., "Extending Time Distribution and Timeliness Capabilities over the Air to Enable Future Wireless Industrial Automation Systems, the Proceedings of IEEE", June 2019.

[**Nitsche_2015**] Thomas Nitsche et al., "IEEE 802.11ad: directional 60 GHz communication for multi-Gigabit-per-second Wi-Fi", December 2014.

[**Ghasempour_2017**] Yasaman Ghasempour et al., "802.11ay: Next-Generation 60 GHz Communications for 100 Gb/s Wi-Fi", December 2017.

[**IEEE_doc_11-18-2009-06**] IEEE standard for Information Technology, "802.11 Real-Time Applications (RTA) Topic Interest Group (TIG) Report", November 2018.

[**IEEE_doc_11-19-0373-00**] Kevin Stanton et Al., "Time-Sensitive Applications Support in EHT", March 2019.

[**morell13**] Antoni Morell et al., "Label switching over IEEE802.15.4e networks", April 2013.

[**dearmas16**] Jesica de Armas et al., "Determinism through path diversity: Why packet replication makes sense", September 2016.

[**vilajosana19**] Xavier Vilajosana et al., "6TiSCH: Industrial Performance for IPv6 Internet-of-Things Networks", June 2019.

[**ISA100.11a**] ISA/IEC, "ISA100.11a, Wireless Systems for Automation, also IEC 62734", 2011, <<http://www.isa100wci.org/en-US/Documents/PDF/3405-ISA100-WirelessSystems-Future-broch-WEB-ETSI.aspx>>.

[WirelessHART]

www.hartcomm.org, "Industrial Communication Networks - Wireless Communication Network and Communication Profiles - WirelessHART - IEC 62591", 2010.

[PCE] IETF, "Path Computation Element", <<https://dataTracker.ietf.org/doc/charter-ietf-pce/>>.

[CCAMP] IETF, "Common Control and Measurement Plane", <<https://dataTracker.ietf.org/doc/charter-ietf-ccamp/>>.

[TiSCH] IETF, "IPv6 over the TSCH mode over 802.15.4", <<https://dataTracker.ietf.org/doc/charter-ietf-6tisch/>>.

[RIH18]

Rihacek, C., Haindl, B., Fantappie, P., Pierattelli, S., Gräupl, T., Schnell, M., and N. Fistas, "L-band Digital Aeronautical Communications System (LDACS) Activities in SESAR2020", Proceedings of the Integrated Communications Navigation and Surveillance Conference (ICNS) Herndon, VA, USA, April 2018.

[GRA19] Gräupl, T., Rihacek, C., and B. Haindl, "LDACS A/G Specification", SESAR2020 PJ14-02-01 D3.3.010, February 2019.

[SAJ14] Sajatovic, M., Günzel, H., and S. Müller, "WA04 D22 Test Report for Assessing LDACS1 Transmitter Impact upon DME/TACAN Receivers", April 2014.

[GRA11] Gräupl, T. and M. Ehammer, "L-DACS1 Data Link Layer Evolution of ATN/IPS", Proceedings of the 30th IEEE/AIAA Digital Avionics Systems Conference (DASC) Seattle, WA, USA, October 2011.

[ICA018] International Civil Aviation Organization (ICAO), "L-Band Digital Aeronautical Communication System (LDACS)", International Standards and Recommended Practices Annex 10 - Aeronautical Telecommunications, Vol. III - Communication Systems, July 2018.

[GRA18] al., T. G. E., "L-band Digital Aeronautical Communications System (LDACS) flight trials in the national German project MICONAV", Proceedings of the Integrated Communications, Navigation, Surveillance Conference (ICNS) Herndon, VA, USA, April 2018.

[SCH19] Schnell, M., "DLR tests digital communications technologies combined with additional navigation functions for the first time", 3 March 2019, <<https://>

[www.dlr.de/dlr/en/desktopdefault.aspx/
tabid-10081/151_read-32951/#/gallery/33877](http://www.dlr.de/dlr/en/desktopdefault.aspx/tabid-10081/151_read-32951/#/gallery/33877)>.

- [TR37910] 3GPP, "Study on self evaluation towards IMT-2020 submission", 3GPP TR 37.910, <<https://portal.3gpp.org/desktopmodules/Specifications/SpecificationDetails.aspx?specificationId=3190>>.
- [TR38824] 3GPP, "Study on physical layer enhancements for NR ultra-reliable and low latency case (URLLC)", 3GPP TR 38.824, <<https://portal.3gpp.org/desktopmodules/Specifications/SpecificationDetails.aspx?specificationId=3498>>.
- [TR38825] 3GPP, "Study on NR industrial Internet of Things (IoT)", 3GPP TR 38.825, <<https://portal.3gpp.org/desktopmodules/Specifications/SpecificationDetails.aspx?specificationId=3492>>.
- [TS22104] 3GPP, "Service requirements for cyber-physical control applications in vertical domains", 3GPP TS 22.104, <<https://portal.3gpp.org/desktopmodules/Specifications/SpecificationDetails.aspx?specificationId=3528>>.
- [TR22804] 3GPP, "Study on Communication for Automation in Vertical domains (CAV)", 3GPP TS 22.804, <<https://portal.3gpp.org/desktopmodules/Specifications/SpecificationDetails.aspx?specificationId=3187>>.
- [TS23501] 3GPP, "System architecture for the 5G System (5GS)", 3GPP TS 23.501, <<https://portal.3gpp.org/desktopmodules/Specifications/SpecificationDetails.aspx?specificationId=3144>>.
- [TS38300] 3GPP, "NR Overall description", 3GPP TS 38.300, <<https://portal.3gpp.org/desktopmodules/Specifications/SpecificationDetails.aspx?specificationId=3191>>.
- [RP210854] 3GPP, "Revised WID: Enhanced Industrial Internet of Things (IoT) and ultra-reliable and low latency communication (URLLC) support for NR", 3GPP RP-210854, March 2021, <https://www.3gpp.org/ftp/tsg_ran/TSG_RAN/TSGR_91e/Docs/RP-210854.zip>.
- [TR2370046] 3GPP, "Study on 5GS DetNet interworking", 3GPP TR23.700-46, August 2022, <<https://portal.3gpp.org/desktopmodules/Specifications/SpecificationDetails.aspx?specificationId=3994>>.
- [SP211634] 3GPP, "Study on 5G Timing Resiliency, TSC, and URLLC enhancements", 3GPP SP-211634, December 2021, <<https://>

www.3gpp.org/ftp/tsg_sa/TSG_SA/TSGS_94E_Electronic_2021_12/Docs/SP-211634.zip>.

- [IMT2020] "ITU towards IMT for 2020 and beyond", <<https://www.itu.int/en/ITU-R/study-groups/rsg5/rwp5d/imt-2020/Pages/default.aspx>>.
- [IEEE802.1TSN] IEEE 802.1, "Time-Sensitive Networking (TSN) Task Group", <<http://www.ieee802.org/1/pages/tsn.html>>.
- [IEEE802.1AS] IEEE, "IEEE Standard for Local and metropolitan area networks -- Timing and Synchronization for Time-Sensitive Applications", IEEE 802.1AS-2020, <https://standards.ieee.org/content/ieee-standards/en/standard/802_1AS-2020.html>.
- [IEEE802.1CB] IEEE, "IEEE Standard for Local and metropolitan area networks -- Frame Replication and Elimination for Reliability", DOI 10.1109/IEEEStd2017.8091139, IEEE 802.1CB-2017, <<https://ieeexplore.ieee.org/document/8091139>>.
- [IEEE802.1Qbv] IEEE, "IEEE Standard for Local and metropolitan area networks -- Bridges and Bridged Networks -- Amendment 25: Enhancements for Scheduled Traffic", IEEE 802.1Qbv-2015, <<https://ieeexplore.ieee.org/document/7440741>>.
- [IEEE802.1Qcc] IEEE, "IEEE Standard for Local and metropolitan area networks -- Bridges and Bridged Networks -- Amendment 31: Stream Reservation Protocol (SRP) Enhancements and Performance Improvements", IEEE 802.1Qcc-2018, <<https://ieeexplore.ieee.org/document/8514112>>.
- [IEEE802.3] IEEE, "IEEE Standard for Ethernet", IEEE 802.3-2018, <<https://ieeexplore.ieee.org/document/8457469>>.
- [TSN5G] 5G-ACIA, "Integration of 5G with Time-Sensitive Networking for Industrial Communications", 5G-ACIA whitepaper, <<https://5g-acia.org/whitepapers/integration-of-5g-with-time-sensitive-networking-for-industrial-communications>>.
- [MAE18] Maeurer, N. and A. Bilzhause, "A Cybersecurity Architecture for the L-band Digital Aeronautical Communications System (LDACS)", IEEE 37th Digital Avionics Systems Conference (DASC), pp. 1-10, London, UK, 2017.
- [MAE191] Maeurer, N. and C. Schmitt, "Towards Successful Realization of the LDACS Cybersecurity Architecture: An

Updated Datalink Security Threat- and Risk Analysis", IEEE Integrated Communications, Navigation and Surveillance Conference (ICNS), pp. 1-13, Herndon, VA, USA , 2019.

[ICAO19] International Civil Aviation Organization (ICAO), "TLDACS White Paper-A Roll-out Scenario", Working Paper COMMUNICATIONS PANEL-DATA COMMUNICATIONS INFRASTRUCTURE WORKING GROUP, Montreal, Canada , October 2019.

[MAE192] Maeurer, N., Graeupl, T., and C. Schmitt, "Evaluation of the LDACS Cybersecurity Implementation", IEEE 38th Digital Avionics Systems Conference (DACS), pp. 1-10, San Diego, CA, USA , September 2019.

[MAE20] Maeurer, N., Graeupl, T., and C. Schmitt, "Comparing Different Diffie-Hellman Key Exchange Flavors for LDACS", IEEE 39th Digital Avionics Systems Conference (DACS), pp. 1-10, San Diego, CA, USA , October 2019.

[FIL19] Filip-Dhaubhadel, A. and D. Shutin, "LDACS- Based Non-Cooperative Surveillance Multistatic Radar Design and Detection Coverage Assessment", IEEE 38th Digital Avionics Systems Conference (DACS), pp. 1-10, San Diego, CA, USA , September 2019.

[BAT19] Battista, G., Osechas, O., Narayanan, S., Crespillo, O.G., Gerbeth, D., Maeurer, N., Mielke, D., and T. Graeupl, "Real-Time Demonstration of Integrated Communication and Navigation Services Using LDACS", IEEE Integrated Communications, Navigation and Surveillance Conference (ICNS), pp. 1-12, Herndon, VA, USA , 2019.

[BRA06] Brandes, S., Schnell, M., Rokitansky, C.H., Ehammer, M., Graeupl, T., Steendam, H., Guenach, M., Rihacek, C., and B. Haindl, "B-VHF -Selected Simulation Results and Final Assessment", IEEE 25th Digital Avionics Systems Conference (DACS), pp. 1-12, New York, NY, USA , September 2019.

[SCH08] Schnell, M., Brandes, S., Gligorevic, S., Rokitansky, C.H., Ehammer, M., Graeupl, T., Rihacek, C., and M. Sajatovic, "B-AMC - Broadband Aeronautical Multi-carrier Communications", IEEE 8th Integrated Communications, Navigation and Surveillance Conference (ICNS), pp. 1-13, New York, NY, USA , April 2008.

[HAI09]

Haindl, B., Rihacek, C., Sajatovic, M., Phillips, B., Budinger, J., Schnell, M., Kamiano, D., and W. Wilson, "Improvement of L-DACS1 Design by Combining B-AMC with P34 and WiMAX Technologies", IEEE 9th Integrated Communications, Navigation and Surveillance Conference (ICNS), pp. 1-8, New York, NY, USA , May 2009.

[EHA11]

Ehammer, M. and T. Graeupl, "AeroMACS - An Airport Communications System", IEEE 30th Digital Avionics Systems Conference (DACS), pp. 1-16, New York, NY, USA , September 2011.

[SCH14]

Schnell, M., Epple, U., Shutin, D., and N. Schneckenburger, "LDACS: Future Aeronautical Communications for Air- Traffic Management", IEEE Communications Magazine, 52(5), 104-110 , 2017.

[Cavalcanti1287]

Cavalcanti, D., Venkatesan, G., Cariou, L., and C. Cordeiro, "TSN support in 802.11 and potential extensions for TGbe", 2019, <<https://mentor.ieee.org/802.11/dcn/19/11-19-1287>>.

[Sudhakaran2021]

Sudhakaran, S., Montgomery, K., Kashef, M., Cavalcanti, D., and R. Candell, "Wireless Time Sensitive Networking for Industrial Collaborative Robotic Workcells", 17th IEEE International Conference on Factory Communication Systems (WFCS) , 2021, <<https://ieeexplore.ieee.org/abstract/document/9483447>>.

[Fang_2021]

Fang, J., Cavalcanti, D., Cordeiro, C., and C. Cheng, "Wireless TSN with Multi-Radio Wi-Fi", IEEE International Conference on Standards for Communications and Networking, December 2021. , 2021.

Authors' Addresses

Pascal Thubert (editor)
Cisco Systems, Inc
Building D
45 Allee des Ormes - BP1200
06254 MOUGINS - Sophia Antipolis
France

Phone: [+33 497 23 26 34](tel:+33497232634)
Email: pthubert@cisco.com

Dave Cavalcanti
Intel Corporation
2111 NE 25th Ave

Hillsboro, OR, 97124
United States of America

Phone: [503 712 5566](tel:5037125566)
Email: dave.cavalcanti@intel.com

Xavier Vilajosana
Universitat Oberta de Catalunya
156 Rambla Poblenou
08018 Barcelona Catalonia
Spain

Email: xvilajosana@uoc.edu

Corinna Schmitt
Research Institute CODE, UniBw M
Werner-Heisenberg-Weg 39
85577 Neubiberg
Germany

Email: corinna.schmitt@unibw.de

Janos Farkas
Ericsson
Budapest
Magyar tudosok korutja 11
1117
Hungary

Email: janos.farkas@ericsson.com