

Service Function Chaining
Internet-Draft
Intended status: Informational
Expires: December 15, 2018

D. Dolson
Sandvine
S. Homma
NTT
D. Lopez
Telefonica I+D
M. Boucadair
Orange
June 13, 2018

Hierarchical Service Function Chaining (hSFC)
draft-ietf-sfc-hierarchical-09

Abstract

Hierarchical Service Function Chaining (hSFC) is a network architecture allowing an organization to decompose a large-scale network into multiple domains of administration.

The goals of hSFC are to make a large-scale network easier to reason about, simpler to control and to support independent functional groups within large network operators.

Status of This Memo

This Internet-Draft is submitted in full conformance with the provisions of [BCP 78](#) and [BCP 79](#).

Internet-Drafts are working documents of the Internet Engineering Task Force (IETF). Note that other groups may also distribute working documents as Internet-Drafts. The list of current Internet-Drafts is at <https://datatracker.ietf.org/drafts/current/>.

Internet-Drafts are draft documents valid for a maximum of six months and may be updated, replaced, or obsoleted by other documents at any time. It is inappropriate to use Internet-Drafts as reference material or to cite them other than as "work in progress."

This Internet-Draft will expire on December 15, 2018.

Copyright Notice

Copyright (c) 2018 IETF Trust and the persons identified as the document authors. All rights reserved.

This document is subject to [BCP 78](#) and the IETF Trust's Legal Provisions Relating to IETF Documents

Internet-Draft

hSFC

June 2018

(<https://trustee.ietf.org/license-info>) in effect on the date of publication of this document. Please review these documents carefully, as they describe your rights and restrictions with respect to this document. Code Components extracted from this document must include Simplified BSD License text as described in Section 4.e of the Trust Legal Provisions and are provided without warranty as described in the Simplified BSD License.

Table of Contents

1.	Introduction	2
2.	Terminology	4
3.	Hierarchical Service Function Chaining (hSFC)	4
3.1.	Top Level	4
3.2.	Lower Levels	6
4.	Internal Boundary Node (IBN)	8
4.1.	IBN Path Configuration	8
4.1.1.	Flow-Stateful IBN	9
4.1.2.	Encoding Upper-Level Paths in Metadata	10
4.1.3.	Using Unique Paths per Upper-Level Path	11
4.1.4.	Nesting Upper-Level NSH within Lower-Level NSH	11
4.1.5.	Stateful/Metadata Hybrid	12
4.2.	Gluing Levels Together	14
4.3.	Decrementing Service Index	14
4.4.	Managing TTL	14
5.	Sub-domain Classifier	15
6.	Control Plane Elements	15
7.	Extension for Adapting to NSH-Unaware Service Functions	16
7.1.	Purpose	17
7.2.	Requirements for IBN	18
8.	Acknowledgements	19
9.	IANA Considerations	19
10.	Security Considerations	19
10.1.	Control Plane	20
10.2.	Infinite Forwarding Loops	20
11.	References	20
11.1.	Normative References	20
11.2.	Informative References	20
Appendix A.	Examples of Hierarchical Service Function Chaining	21
A.1.	Reducing the Number of Service Function Paths	22
A.2.	Managing a Distributed Data-Center Network	24
	Authors' Addresses	26

1. Introduction

Service Function Chaining (SFC) is a technique for prescribing differentiated traffic forwarding policies within an SFC-enabled

domain. The SFC architecture is described in detail in [[RFC7665](#)], and is not repeated here.

This document focuses on the difficult problem of implementing SFC across a large, geographically dispersed network, potentially comprised of millions of hosts and thousands of network forwarding elements, and which may involve multiple operational teams (with varying functional responsibilities). We recognize that some stateful Service Functions (SFs) require bidirectional traffic for transport-layer sessions (e.g., NATs, firewalls). We assume that some Service Function Paths (SFPs) need to be selected on the basis of transport-layer coordinate (typically, the 5-tuple of source IP address, source port number, destination IP address, destination port number, and transport protocol) stickiness to specific stateful SF instances.

Difficult problems are often made easier by decomposing them in a hierarchical (nested) manner. So instead of considering a single SFC Control Plane that can manage (create, withdraw, supervise, etc.) complete SFPs from one end of the network to the other, we decompose the network into smaller domains operated by as many SFC control plane components (under the same administrative entity). Coordination between such components is further discussed in the document.

Each sub-domain may support a subset of the network applications or a subset of the users. Decomposing a network should be done with care to ease monitoring and troubleshooting of the network and services as a whole. The criteria for decomposing a domain into multiple SFC-enabled sub-domains are beyond the scope of this document. These criteria are deployment-specific.

An example of simplifying a network by using multiple SFC-enabled domains is further discussed in [[I-D.ietf-sfc-dc-use-cases](#)].

We assume the SFC-aware nodes use Network Service Header (NSH)

[[RFC8300](#)] or a similar labeling mechanism. Sample examples are described in [Appendix A](#).

The SFC-enabled domains discussed in this document are assumed to be under the control of a single organization (an operator, typically), such that there is a strong trust relationship between the domains. The intention of creating multiple domains is to improve the ability to operate a network. It is outside of the scope of the document to consider domains operated by different organizations or to dwell on inter-operator considerations.

We introduce the concept of an Internal Boundary Node (IBN) that acts as a gateway between the levels of the hierarchy. We also discuss options for realizing this function.

[2.](#) Terminology

This document makes use of the terms defined in [Section 1.4 of \[RFC7665\]](#) and [Section 1.3 of \[RFC8300\]](#).

The following terms are defined:

- o High-level: encompasses the entire network domain to be managed.
- o Lower-level: encompasses a portion of the network (called, sub-domain).
- o Internal Boundary Node (IBN): is responsible for bridging packets between higher and lower levels of SFC-enabled domains.

[3.](#) Hierarchical Service Function Chaining (hSFC)

A hierarchy has multiple levels: the top-most level encompasses the entire network domain to be managed, and lower levels encompass portions of the network. These levels are discussed in the following sub-sections.

[3.1.](#) Top Level

Considering the example depicted in Figure 1, a top-level network

domain includes SFC data plane components distributed over a wide area, including:

- o Classifiers (CFs),
- o Service Function Forwarders (SFFs) and
- o Sub-domains.

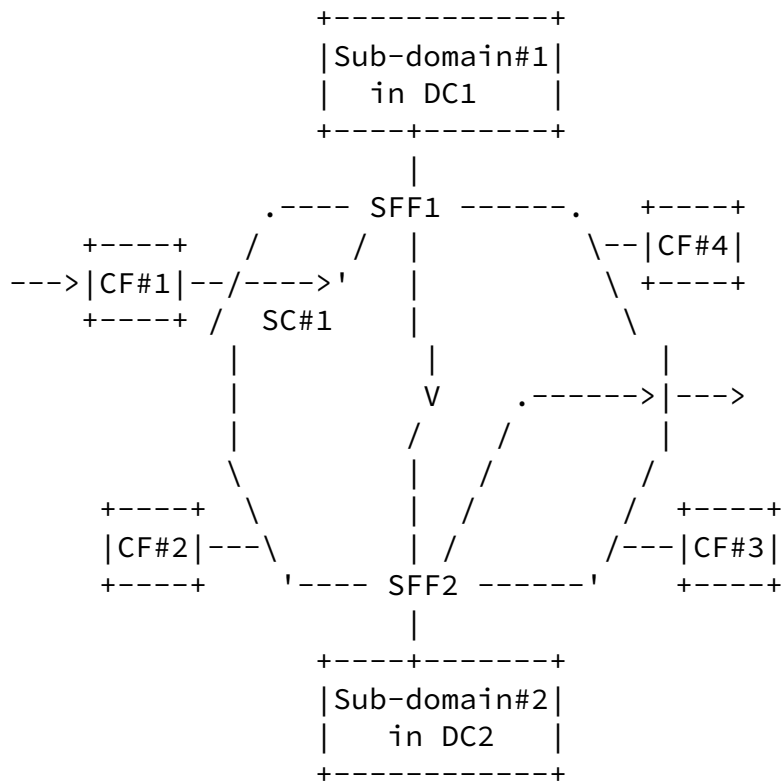

Legend:

SC#1: Service Chain 1

DC: Data Center

Figure 1: Network-wide view of top level of hierarchy

One path is shown from edge classifier (CF#1) to SFF1 to Sub-domain#1 (residing in data-center1) to SFF1 to SFF2 (residing in data-center 2) to Sub-domain#2 to SFF2 to network egress.

For the sake of clarity, components of the underlay network are not shown; an underlay network is assumed to provide connectivity between SFC data plane components.

Top-level SFPs carry packets from classifiers through a set of SFFs and sub-domains, with the operations within sub-domains being opaque to the higher levels.

We expect the system to include a top-level control plane having responsibility for configuring forwarding policies and traffic classification rules.

The top-level Service Chaining control plane manages end-to-end service chains and associated service function paths from network edge points to sub-domains and configures top-level classifiers at a

coarse level (e.g., based on source or destination host) to forward traffic along paths that will transit across appropriate sub-domains.

Figure 1 shows one possible service chain passing from edge, through two sub-domains, to network egress. The top-level control plane does not configure traffic classification rules or forwarding policies within the sub-domains.

At this network-wide level, the number of SFPs required is a linear function of the number of ways in which a packet is required to traverse different sub-domains and egress the network. Note that the various paths which may be followed within a sub-domain are not represented by distinct network-wide SFPs; specific policies at the ingress nodes of each sub-domain bind flows to sub-domain paths.

Packets are classified at the edge of the network to select the paths by which sub-domains are to be traversed. At the ingress of each sub-domain, packets are reclassified to paths directing them to the required SFs of the sub-domain. At the egress of each sub-domain, packets are returned to the top-level paths. Contrast this with an approach requiring the top-level classifier to select paths to specify all of the SFs in each sub-domain.

It should be assumed that some SFs require bidirectional symmetry of paths (see more in [Section 5](#)). Therefore the classifiers at the top level must be configured with policies ensuring outgoing packets take the reverse path of incoming packets through sub-domains.

[3.2](#). Lower Levels

Each of the sub-domains in Figure 1 is an SFC-enabled domain.

Figure 2 shows a sub-domain interfaced with a higher-level domain by means of an Internal Boundary Node (IBN). An IBN acts as an SFC-aware SF in the higher-level domain and as a classifier in the lower-level domain. As such, data packets entering the sub-domain are already SFC-encapsulated. Also, it is the purpose of the IBN to apply classification rules and direct the packets to the selected local SFPs terminating at an egress IBN. The egress IBN finally restores packets to the original SFC shim and hands them off to SFFs.

Each sub-domain intersects a subset of the total paths that are possible in the higher-level domain. An IBN is concerned with higher-level paths, but only those traversing its sub-domain.

Each sub-domain is likely to have a control plane that can operate independently of the top-level control plane, managing classification, forwarding paths, etc. within the level of the sub-

domain, with the details being opaque to the upper-level control elements. [Section 4](#) provides more details about the behavior of an IBN.

The sub-domain control plane configures the classification rules in the IBN, where SFC encapsulation of the top-level domain is converted to/from SFC encapsulation of the lower-level domain. The sub-domain control plane also configures the forwarding rules in the SFFs of the

sub-domain.

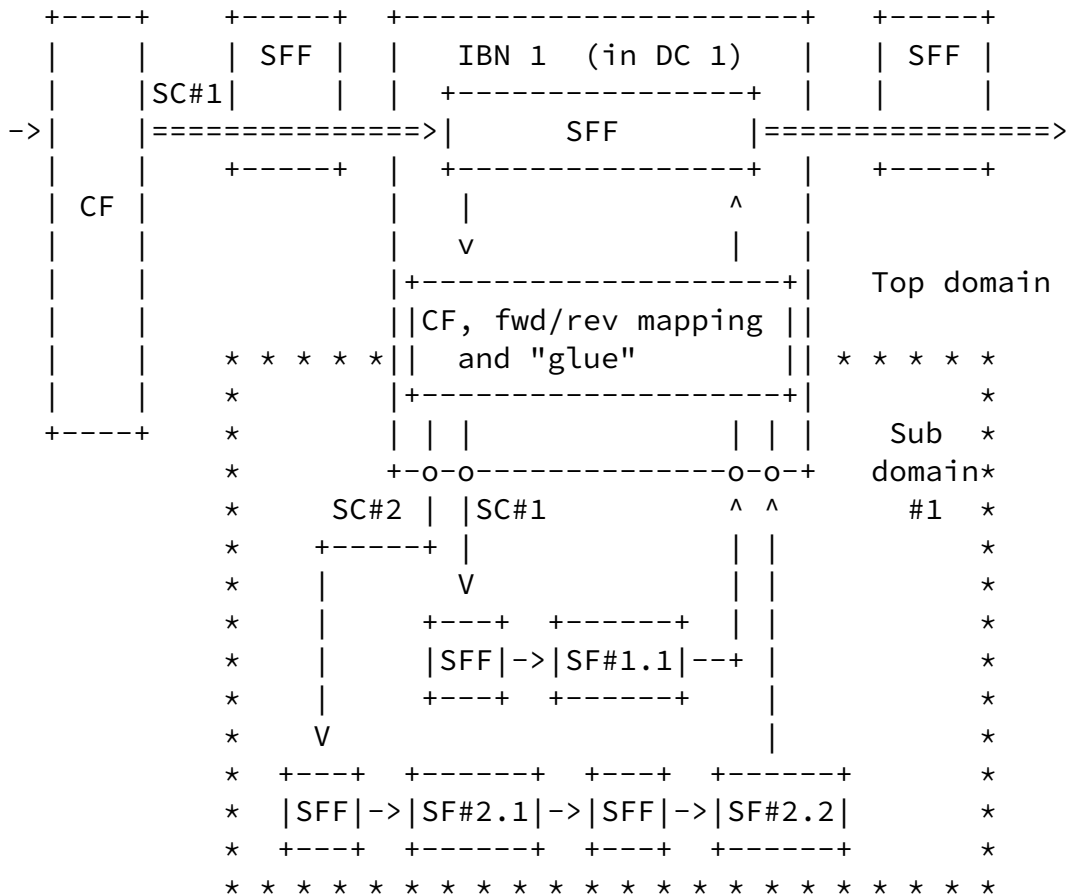

- Legend:
- *** Sub-domain boundary
 - === top-level chain
 - low-level chain

Figure 2: Example of a sub-domain within a higher-level domain

If desired, the pattern can be applied recursively. For example, SF#1.1 in Figure 2 could be a sub-domain of the sub-domain.

4. Internal Boundary Node (IBN)

As mentioned in the previous section, a network element termed "Internal Boundary Node" (IBN) is responsible for bridging packets between higher and lower layers of SFC-enabled domains. It behaves as an SF to the higher level ([Section 3.1](#)), and looks like a classifier and end-of-chain to the lower level ([Section 3.2](#)).

To achieve the benefits of hierarchy, the IBN should be applying more granular traffic classification rules at the lower level than the traffic passed to it. This means that the number of SFPs within the lower level is greater than the number of SFPs arriving to the IBN.

The IBN is also the termination of lower-level SFPs. This is because the packets exiting lower-level SF paths must be returned to the higher-level SF paths and forwarded to the next hop in the higher-level domain.

When different metadata schemes are used at different levels, the IBN has further responsibilities: when packets enter the sub-domain, the IBN translates upper-level metadata into lower-level metadata; and when packets leave the sub-domain at the termination of lower-level SFPs, the IBN translates lower-level metadata into upper-level metadata.

Appropriately configuring IBNs is key to ensure the consistency of the overall SFC operation within a given domain that enables hSFC. Classification rules (or lack thereof) in the IBN classifier can of course impact higher levels.

[4.1](#). IBN Path Configuration

The lower-level domain may be provisioned with valid high-level paths or may allow any high-level paths.

When packets enter the sub-domain, the Service Path Identifier (SPI) and Service Index (SI) are re-marked according to the path selected by the (sub-domain) classifier.

At the termination of an SFP in the sub-domain, packets can be restored to an original upper-level SFP by implementing one of these methods:

1. Saving SPI and SI in transport-layer flow state ([Section 4.1.1](#)).
2. Pushing SPI and SI into a metadata header ([Section 4.1.2](#)).

3. Using unique lower-level paths per upper-level path coordinates ([Section 4.1.3](#)).
4. Nesting NSH headers, encapsulating the higher-level NSH headers within the lower-level NSH headers ([Section 4.1.4](#)).
5. Saving upper-level by a flow identifier (ID) and placing an hSFC flow ID into a metadata header ([Section 4.1.5](#)).

[4.1.1](#). Flow-Stateful IBN

An IBN can be flow-aware, returning packets to the correct higher-level SFP on the basis, for example, of the transport-layer coordinates (typically, a 5-tuple) of packets exiting the lower-level SFPs.

When packets are received by the IBN on a higher-level path, the classifier parses encapsulated packets for IP and transport-layer (TCP, UDP, etc.) coordinates. State is created, indexed by some or all transport-coordinates ({source-IP, destination-IP, source-port, destination-port and transport protocol}, typically). The state contains at minimum the critical fields of the encapsulating SFC header (SPI, SI, MD Type, flags); additional information carried in the packet (metadata, TTL) may also be extracted and saved as state. Note, that the some fields of a packet may be altered by an SF of the sub-domain (e.g., source IP address).

Note that this state is only accessed by the classifier and terminator functions of the sub-domain. Neither the SFFs nor SFs have knowledge of this state; in fact they may be agnostic about being in a sub-domain.

One approach is to ensure that packets are terminated at the same IBN at the end of the chain that classified the packet at the start of the chain. If the packet is returned to a different egress IBN, state must be synchronized between the IBNs.

When a packet returns to the IBN at the end of a chain (which is the SFP terminating node of the lower-level chain), the SFC header is removed, the packet is parsed for flow-identifying information, and state is retrieved from them. The state contains the information required to forward the packet within the higher-level service chain.

State cannot be created by packets arriving from the lower-level chain; when state cannot be found for such packets, they must be dropped.

This stateful approach is limited to use with SFs that retain the transport coordinates of the packet. This approach cannot be used with SFs that modify those coordinates (e.g., NATs) or otherwise create packets for new coordinates other than those received (e.g., as an HTTP cache might do to retrieve content on behalf of the original flow). In both cases, the fundamental problem is the inability to forward packets when state cannot be found for the packet transport-layer coordinates.

In the stateful approach, there are issues caused by having state, such as how long the state should be maintained, as well as whether the state needs to be replicated to other devices to create a highly available network.

It is valid to consider the state to be disposable after failure, since it can be re-created by each new packet arriving from the higher-level domain. For example, if an IBN loses all flow state, the state is re-created by an end-point retransmitting a TCP packet.

If an SFC domain handles multiple network regions (e.g., multiple private networks), the coordinates may be augmented with additional parameters, perhaps using some metadata to identify the network region.

In this stateful approach, it is not necessary for the sub-domain's control plane to modify paths when higher-level paths are changed. The complexity of the higher-level domain does not cause complexity in the lower-level domain.

Since it doesn't depend on NSH in the lower domain, this flow-stateful approach can be applied to translation methods of converting NSH to other forwarding techniques (refer to [Section 7](#)).

[4.1.2](#). Encoding Upper-Level Paths in Metadata

An IBN can push the upper-level SPI and SI (or encoding thereof) into a metadata field of the lower-level encapsulation (e.g., placing upper-level path information into a metadata field of NSH). When packets exit the lower-level path, the upper-level SPI and SI can be

restored from the metadata retrieved from the packet.

This approach requires the SFs in the path to be capable of forwarding the metadata and appropriately attaching metadata to any packets injected for a flow.

Using new metadata header may inflate packet size when variable-length metadata (NSH MD Type 0x2) is used.

It is conceivable that the MD Type 0x1 Fixed-Length Context Header field of NSH are not all relevant to the lower-level domain. In this case, 32 bits of the Fixed Length Context Header could be repurposed within the lower-level domain, and restored when leaving.

If flags or TTL (see [Section 4.4](#)) from the original header also need to be saved, more metadata space will be consumed.

In this metadata approach, it is not necessary for the sub-domain's control element to modify paths when higher-level paths are changed. The complexity of the higher-level domain does not increase complexity in the lower-level domain.

[4.1.3](#). Using Unique Paths per Upper-Level Path

This approach assumes that paths within the sub-domain are constrained so that a SPI (of the sub-domain) unambiguously indicates the egress SPI and SI (of the upper domain). This allows the original path information to be restored at sub-domain egress from a look-up table using the sub-domain SPI.

Whenever the upper-level domain provisions a path via the lower-level domain, the lower-level domain control plane must provision corresponding paths to traverse the lower-level domain.

A down-side of this approach is that the number of paths in the lower-level domain is multiplied by the number of paths in the higher-level domain that traverse the lower-level domain. I.e., a sub-path must be created for each combination of upper SPI/SI and lower chain. The number of paths required for lower-level domains will increase exponentially as hierarchy becomes deep.

A further down-side of this approach is that it requires upper and lower levels to utilize the same metadata configuration.

Furthermore, this approach does not allow any information to be stashed away in state or embedded in metadata. E.g., the TTL modifications by the lower level cannot be hidden from the upper level.

[4.1.4.](#) Nesting Upper-Level NSH within Lower-Level NSH

When packets arrive at an IBN in the top-level domain, the classifier in the IBN determines the path for the lower-level domain and pushes the new NSH header in front of the original NSH header.

As shown in Figure 3 the Lower-NSH header used to forward packets in the lower-level domain precedes the Upper-NSH header from the top-level domain.

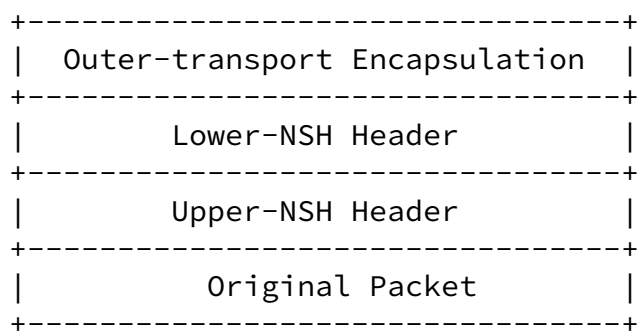

Figure 3: Encapsulation of NSH within NSH

The traffic with the above stack of two NSH headers is to be forwarded according to the Lower-NSH header in the lower-level SFC domain. The Upper-NSH header is preserved in the packets but not used for forwarding. At the last SFF of the chain of the lower-level domain (which resides in the IBN), the Lower-NSH header is removed from the packet, and then the packet is forwarded by the IBN to an SFF of the upper-level domain. The packet will be forwarded in the top-level domain according to the Upper-NSH header.

With such encapsulation, Upper-NSH information is carried along the extent of the lower-level chain without modification.

A benefit of this approach is that it does not require state in the IBN or configuration to encode fields in meta-data. All header fields, including flags and TTL are easily restored when the chains of the sub-domain terminate.

However, the down-side is it does require SFC-aware SFs in the lower-level domain to be able to parse multiple NSH layers. If an SFC-aware SF injects packets, it must also be able to deal with adding appropriate multiple layers of headers to injected packets.

By increasing packet overhead, nesting may lead to fragmentation or decreased MTU in some networks.

[4.1.5. Stateful/Metadata Hybrid](#)

The basic idea of this approach is for the IBN to save upper domain encapsulation information such that it can be retrieved by a unique identifier, termed an "hSFC Flow ID".

The ID is placed, for example, in the NSH Fixed-Length Context Header of the packet in the lower domain, as shown in Figure 4. Likewise, hSFC Flow ID may be encoded as a Variable-Length Context Header when MD Type 0x2 is used.

When packets exit the lower domain, the IBN uses the ID to retrieve the appropriate NSH encapsulation for returning the packet to the upper domain.

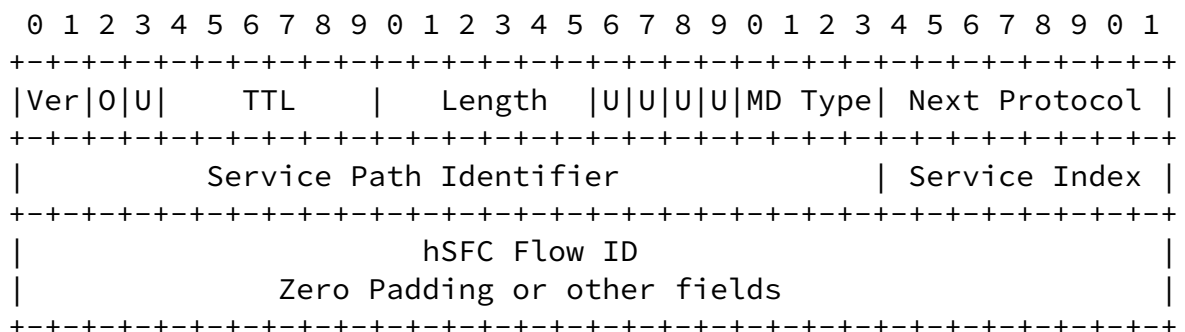

Figure 4: Storing hSFC Flow ID in lower-level NSH Fixed-Length Context Header

Advantages of this approach include:

- o Does not require state based on 5-tuple, so it works with SFs that change the IP addresses or ports of a packet such as NATs.
- o Does not require all domains to have the same metadata scheme.
- o Can be used to restore any upper-domain information, including metadata, flags and TTL, not just service path.
- o The lower domain only requires a single item of metadata regardless of the number of items of metadata used in the upper domain.
- o No special functionality is required to be supported by an SFC-aware SF, other than the usual ability to preserve metadata and to apply metadata to injected packets.

Disadvantages include those of other stateful approaches, including state timeout and replication mentioned in [Section 4.1.1](#).

There may be a large number of unique NSH encapsulations to be stored, given that the hSFC Flow ID must represent all of the bits in the upper-level encapsulation. This might consume a lot of memory or create out-of-memory situations in which IDs cannot be created or old IDs are discarded while still in use.

[4.2](#). Gluing Levels Together

The SPI or metadata included in a packet received by the IBN may be used as input to reclassification and path selection within a lower-level domain.

In some cases the meanings of the various path IDs and metadata must be coordinated between domains for the sake of proper end-to-end SFC operation.

One approach is to use well-known identifier values in metadata,

maintained in a global registry.

Another approach is to use well-known labels for chain identifiers or metadata, as an indirection to the actual identifiers. The actual identifiers can be assigned by control-plane systems. For example, a sub-domain classifier could have a policy, "if pathID = classA then chain packet to path 1234"; the higher-level controller would be expected to configure the concrete higher-level 'pathID' for 'classA'.

[4.3.](#) Decrementing Service Index

Because the IBN acts as an SFC-aware SF to the higher-level domain, it must decrement the Service Index in the NSH headers of the higher-level path. This operation should be undertaken when the packet is first received by the IBN, before applying any of the strategies of [Section 4.1](#), immediately prior to classification.

[4.4.](#) Managing TTL

The NSH base header contains a TTL field [[RFC8300](#)]. There is a choice:

a sub-domain may appear as a pure service function, which should not decrement the TTL from the perspective of the higher-level domain, or

all of the TTL changes within the sub-domain may be visible to the higher-level domain.

Some readers may recognize this as a choice between "pipe" and "uniform" models, respectively [[RFC3443](#)].

The network operator should be given control of this behavior, choosing whether to expose the lower-level topology to the higher layer. An implementation may support per-packet policy, allowing some users to perform a layer-transcending trace-route, for example.

The choice affects whether the methods of restoring the paths in [Section 4.1](#) restore a saved version of TTL or propagate it with the packet. The method of [Section 4.1.3](#) does not permit topology-hiding. The other methods of [Section 4.1.1](#), [Section 4.1.2](#), [Section 4.1.4](#), and

[Section 4.1.5](#) have unique methods for restoring saved versions of TTL.

5. Sub-domain Classifier

Within the sub-domain (referring to Figure 2), as the classifier receives incoming packets, the high-level encapsulation is treated according to one of the methods described in [Section 4.1](#) to either statefully store, encode, or nest header information. The classifier then selects the path and metadata for the packet within the sub-domain.

One of the goals of the hierarchical approach is to make it easy to have transport-flow-aware service chaining with bidirectional paths. For example, it is desired that for each TCP flow, the client-to-server packets traverse the same SF instances as the server-to-client packets, but in the opposite sequence. We call this bidirectional symmetry. If bidirectional symmetry is required, it is the responsibility of the control plane to be aware of symmetric paths and configure the classifier to chain the traffic in a symmetric manner.

Another goal of the hierarchical approach is to simplify the mechanisms of scaling in and scaling out SFs. All of the complexities of load-balancing among multiple SFs can be handled within a sub-domain, under control of the classifier, allowing the higher-level domain to be oblivious to the existence of multiple SF instances.

Considering the requirements of bidirectional symmetry and load-balancing, it is useful to have all packets entering a sub-domain to be received by the same classifier or a coordinated cluster of classifiers. There are both stateful and stateless approaches to ensuring bidirectional symmetry.

6. Control Plane Elements

Although SFC control protocols have not yet been standardized (2018), from the point of view of hierarchical service function chaining we have these expectations:

- o Each control-plane instance manages a single level of hierarchy of a single domain.

- o Each control plane is agnostic about other levels of hierarchy. This aspect allows humans to reason about the system within a single domain and allows control-plane algorithms to use only domain-local inputs. Top-level control does not need visibility to sub-domain policies, nor does sub-domain control need visibility to higher-level policies. (Top-level control considers a sub-domain as though it were an SF.)
- o Sub-domain control planes are agnostic about control planes of other sub-domains. This allows both humans and machines to manipulate sub-domain policy without considering policies of other domains.

Recall that the IBN acts as an SFC-aware SF in the higher-level domain (receiving SF instructions from the higher-level control plane) and as a classifier in the lower-level domain (receiving classification rules from the sub-domain control plane). In this view, it is the IBN that glues the layers together.

The above expectations are not intended to prohibit network-wide control. A control hierarchy can be envisaged to distribute information and instructions to multiple domains and sub-domains. Control hierarchy is outside the scope of this document.

7. Extension for Adapting to NSH-Unaware Service Functions

The hierarchical approach can be used for dividing networks into NSH-aware and NSH-unaware domains by converting NSH encapsulation to other forwarding techniques (e.g., 5-tuple-based routing with OpenFlow), as shown in Figure 5.

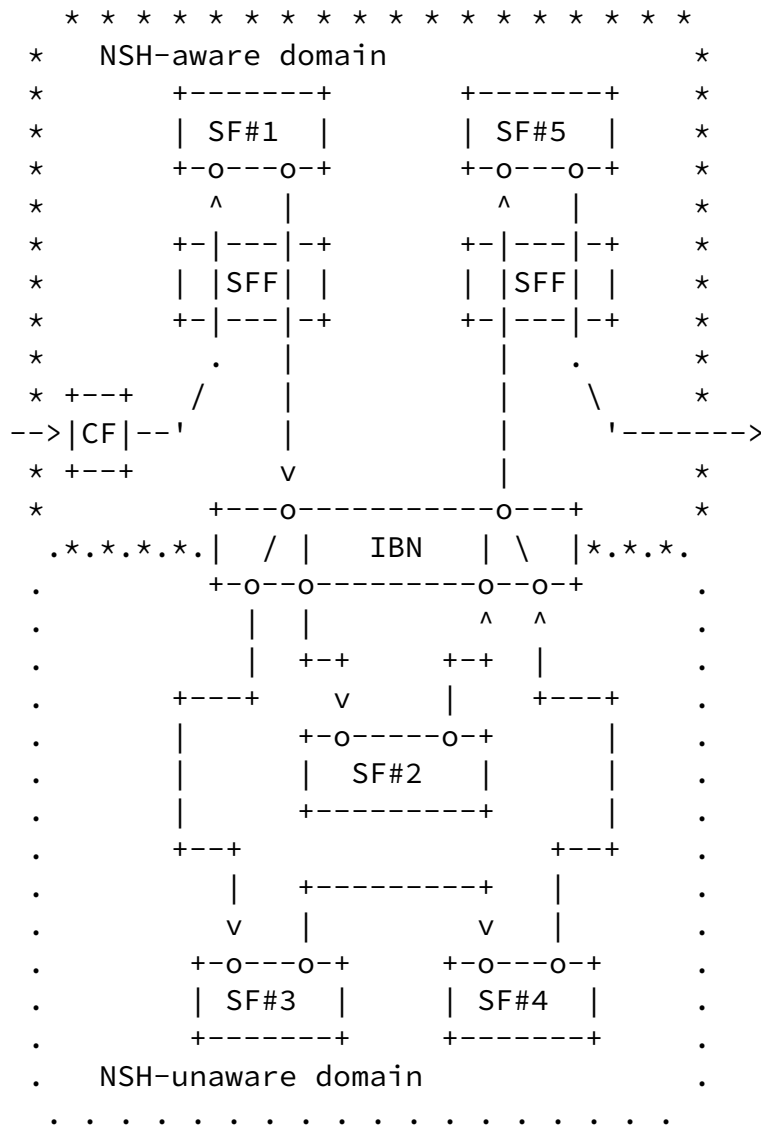

SF#1 and SF#5 are NSH-aware and SF#2, SF#3 and SF#4 are NSH-unaware. In the NSH-unaware domain, packets are conveyed in a format supported by SFs which are deployed there.

Figure 5: Dividing NSH-aware and NSH-unaware domains

[7.1.](#) Purpose

This approach is expected to facilitate service chaining in networks in which NSH-aware and NSH-unaware SFs coexist. Some examples of such situations are:

- o In a period of transition from legacy SFs to NSH-aware SFs, and
- o Supporting multi-tenancy.

[7.2.](#) Requirements for IBN

In this usage, an IBN classifier is required to have an NSH conversion table for applying packets to appropriate lower-level paths and returning packets to the correct higher-level paths. For example, the following methods would be used for saving/restoring upper-level path information:

- o Saving SPI and SI in transport-layer flow state (refer to [Section 4.1.1](#)) and
- o Using unique lower-level paths per upper-level NSH coordinates (refer to [Section 4.1.3](#)).

Especially, the use of unique paths approach would be good for translating NSH to a different forwarding technique in the lower level. A single path in the upper level may be branched to multiple paths in the lower level such that any lower-level path is only used by one upper-level path. This allows unambiguous restoration to the upper-level path.

In addition, an IBN might be required to convert metadata contained in NSH to the format appropriate to the packet in the lower-level path. For example, some legacy SFs identify subscriber based on information of network topology, such as VID (VLAN ID), and IBN would be required to create VLAN to packets from metadata if subscriber identifier is conveyed as metadata in higher-level domains.

Other fundamental functions required as IBN (e.g., maintaining metadata of upper level or decrementing Service Index) are same as normal usage.

It is useful to permit metadata to be transferred between levels of a

hierarchy. Metadata from a higher level may be useful within a sub-domain and a sub-domain may augment metadata for consumption in an upper domain. However, allowing uncontrolled metadata between domains may lead to forwarding failures.

In order to prevent SFs of low-level SFC-enabled domains from supplying (illegitimate) metadata, IBNs may be instructed to permit specific metadata types to exit the sub-domain. Such control over the metadata in the upper level is the responsibility of the upper-level control plane.

To limit unintentional metadata reaching SFs of low-level SFC-enabled sub-domains, IBNs may be instructed to permit specific metadata types into the sub-domain. Such control of metadata in

Dolson, et al.

Expires December 15, 2018

[Page 18]

Internet-Draft

hSFC

June 2018

the low-level domain is the responsibility of the lower-level control plane.

8. Acknowledgements

The concept of Hierarchical Service Path Domains was introduced in [[I-D.homma-sfc-forwarding-methods-analysis](#)] as a means to improve scalability of service chaining in large networks.

The concept of nesting NSH headers within lower-level NSH was contributed by Ting Ao. The concept originally appeared in [[I-D.ao-sfc-for-dc-interconnect](#)] as a means of creating hierarchical SFC in a data center.

We thank Dapeng Liu for contributing the data-center examples in the appendix.

The Stateful/Metadata Hybrid section was contributed by Victor Wu.

The authors would also like to thank the following individuals for providing valuable feedback:

Ron Parker

Christian Jacquenet

Jie Cao

Kyle Larose

Thanks to Ines Robles, Sean Turner, and Vijay Gurbani for their review.

9. IANA Considerations

This memo includes no request to IANA.

10. Security Considerations

Hierarchical service function chaining makes use of service chaining architecture, and hence inherits the security considerations described in the architecture document [[RFC7665](#)].

Furthermore, hierarchical service function chaining inherits security considerations of the data-plane protocols (e.g., NSH) and control-plane protocols used to realize the solution.

Dolson, et al.

Expires December 15, 2018

[Page 19]

Internet-Draft

hSFC

June 2018

This document describes systems that may be managed by distinct teams of a single administrative entity. Sub-domains must have consistent configurations in order to properly forward traffic. Any protocol designed to distribute the configurations must be secure from tampering. Means to prevent attacks from within a network must be enforced. For example, continuously monitoring the network may allow detecting such misbehaviors. hSFC adheres to the same security considerations of [[RFC8300](#)]. Those considerations must be taken into account.

All of the systems and protocols must be secure from modification by untrusted agents.

10.1. Control Plane

Security considerations related to the control plane should be discussed in the corresponding control specification documents (e.g., [[I-D.ietf-bess-nsh-bgp-control-plane](#)], [[I-D.wu-pce-traffic-steering-sfc](#)], or [[I-D.maglione-sfc-nsh-radius](#)]).

10.2. Infinite Forwarding Loops

Distributing policies among multiple domains may lead to forwarding loops. NSH supports the ability to detect loops ([Section 4.3](#) and [Section 4.4](#)), but means to ensure the consistency of the policies should be enabled at all levels of a domain. Within the context of hSFC, it is the responsibility of the Control Elements at all levels to prevent such (unwanted) loops.

11. References

11.1. Normative References

- [RFC7665] Halpern, J., Ed. and C. Pignataro, Ed., "Service Function Chaining (SFC) Architecture", [RFC 7665](#), DOI 10.17487/RFC7665, October 2015, <<https://www.rfc-editor.org/info/rfc7665>>.
- [RFC8300] Quinn, P., Ed., Elzur, U., Ed., and C. Pignataro, Ed., "Network Service Header (NSH)", [RFC 8300](#), DOI 10.17487/RFC8300, January 2018, <<https://www.rfc-editor.org/info/rfc8300>>.

11.2. Informative References

Dolson, et al. Expires December 15, 2018 [Page 20]

Internet-Draft hSFC June 2018

[I-D.ao-sfc-for-dc-interconnect]

Ao, T. and W. Bo, "Hierarchical SFC for DC Interconnection", [draft-ao-sfc-for-dc-interconnect-01](#) (work in progress), October 2015.

[I-D.homma-sfc-forwarding-methods-analysis]

Homma, S., Naito, K., Lopez, D., Stiernerling, M., Dolson, D., Gorbunov, A., Leymann, N., Bottorff, P., and d. don.fedyk@hpe.com, "Analysis on Forwarding Methods for Service Chaining", [draft-homma-sfc-forwarding-methods-analysis-05](#) (work in progress), January 2016.

[I-D.ietf-bess-nsh-bgp-control-plane]
Farrel, A., Drake, J., Rosen, E., Uttaro, J., and L. Jalil, "BGP Control Plane for NSH SFC", [draft-ietf-bess-nsh-bgp-control-plane-03](#) (work in progress), March 2018.

[I-D.ietf-sfc-dc-use-cases]
Kumar, S., Tufail, M., Majee, S., Captari, C., and S. Homma, "Service Function Chaining Use Cases In Data Centers", [draft-ietf-sfc-dc-use-cases-06](#) (work in progress), February 2017.

[I-D.maglione-sfc-nsh-radius]
Maglione, R., Trueba, G., and C. Pignataro, "RADIUS Attributes for NSH", [draft-maglione-sfc-nsh-radius-01](#) (work in progress), October 2016.

[I-D.wu-pce-traffic-steering-sfc]
Wu, Q., Dhody, D., Boucadair, M., Jacquenet, C., and J. Tantsura, "PCEP Extensions for Service Function Chaining (SFC)", [draft-wu-pce-traffic-steering-sfc-12](#) (work in progress), June 2017.

[RFC3443] Agarwal, P. and B. Akyol, "Time To Live (TTL) Processing in Multi-Protocol Label Switching (MPLS) Networks", [RFC 3443](#), DOI 10.17487/RFC3443, January 2003, <<https://www.rfc-editor.org/info/rfc3443>>.

[Appendix A](#). Examples of Hierarchical Service Function Chaining

The advantage of hierarchical service function chaining compared with normal or flat service function chaining is that it can reduce the management complexity significantly. This section discusses examples that show those advantages.

[A.1](#). Reducing the Number of Service Function Paths

In this case, hierarchical service function chaining is used to simplify service function chaining management by reducing the number of SFPs.

As shown in Figure 6, there are two domains, each with different concerns: a Security Domain that selects SFs based on network conditions and an Optimization Domain that selects SFs based on traffic protocol.

In this example there are five security functions deployed in the Security Domain. The Security Domain operator wants to enforce the five different security policies, and the Optimization Domain operator wants to apply different optimizations (either cache or video optimization) to each of these two types of traffic. If we use flat SFC (normal branching), 10 SFPs are needed in each domain. In contrast, if we use hierarchical SFC, only 5 SFPs in Security Domain and 2 SFPs in Optimization Domain will be required, as shown in Figure 7.

In the flat model, the number of SFPs is the product of the number of SFs in all of the domains. In the hSFC model, the number of SFPs is the sum of the number of SFs. For example, adding a "bypass" path in the Optimization Domain would cause the flat model to require 15 paths (5 more), but cause the hSFC model to require one more path in the Optimization Domain.

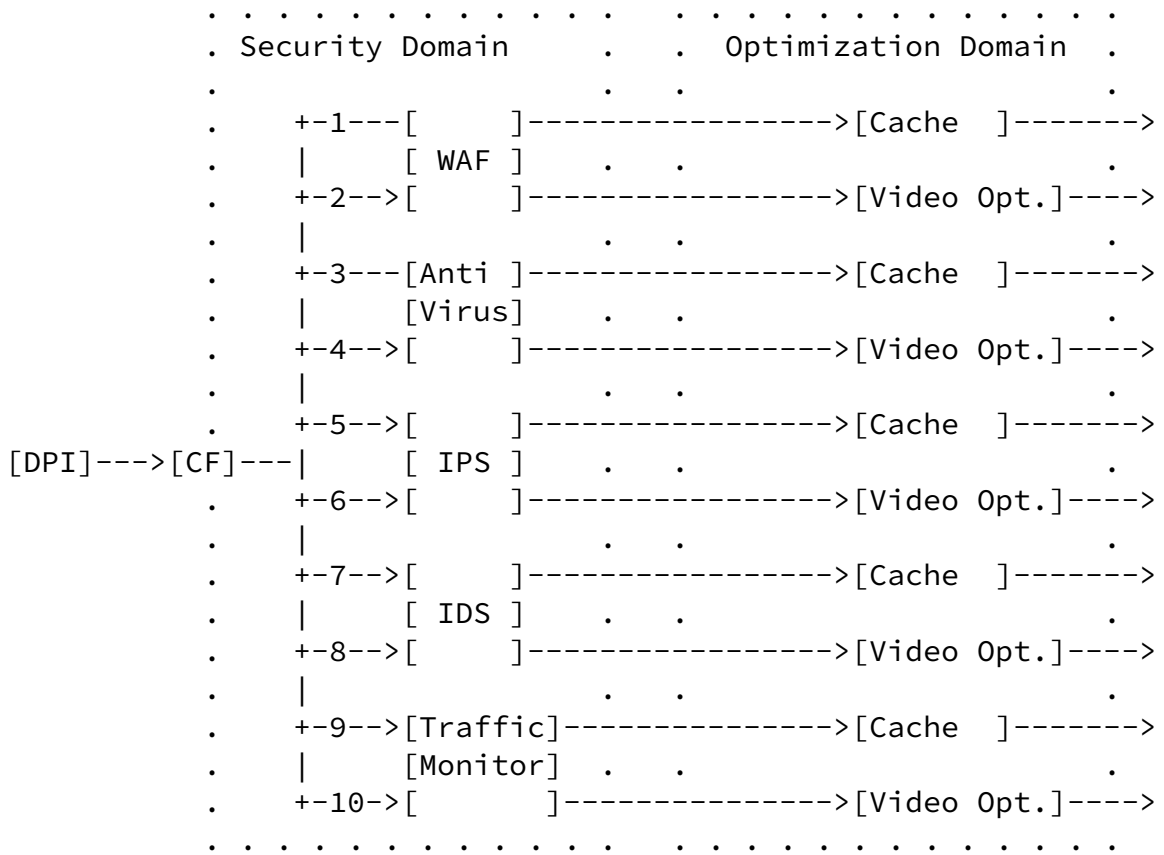

Legend:

- IDS: Intrusion Detection System
- IPS: Intrusion Prevention System
- WAF: Web Application Firewall
- DPI: Deep Packet Inspection

The classifier must select paths that determine the combination of Security and Optimization concerns. 1:WAF+Cache, 2:WAF+VideoOpt, 3:AntiVirus+Cache, 4:AntiVirus+VideoOpt, 5: IPS+Cache, 6:IPS+VideoOpt, 7:IDS+Cache, 8:IDS+VideoOpt, 9:TrafficMonitor+Cache, 10:TrafficMonitor+VideoOpt

Figure 6: Flat SFC (normal branching)

Internet-Draft

hSFC

June 2018

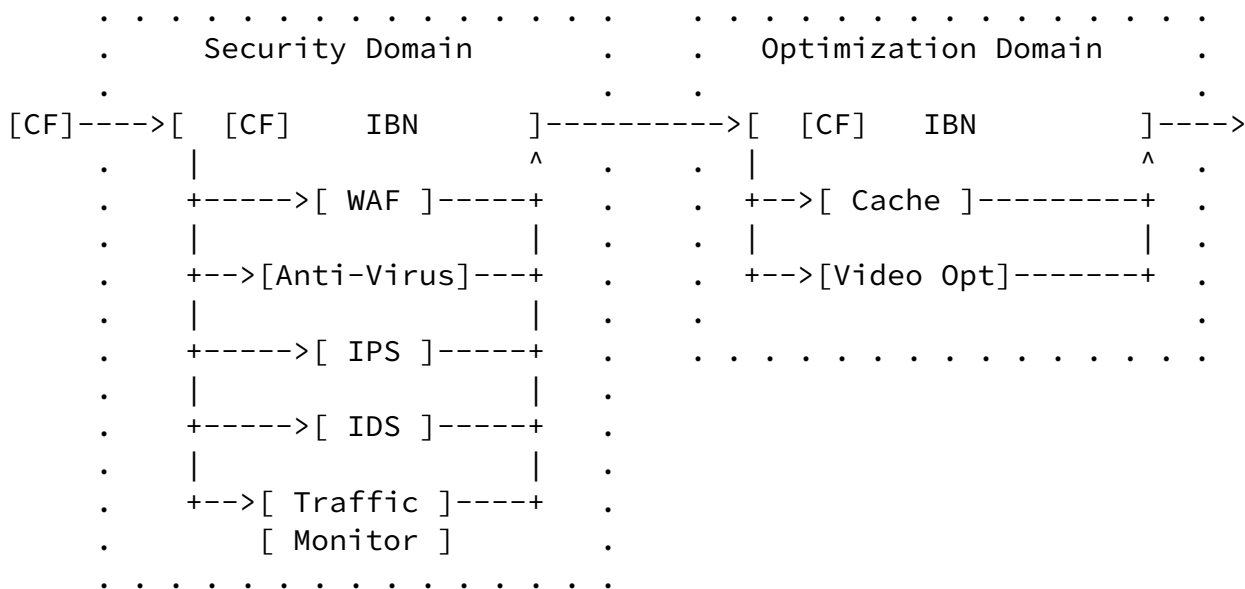

Figure 7: Simplified path management with Hierarchical SFC

[A.2.](#) Managing a Distributed Data-Center Network

Hierarchical service function chaining can be used to simplify inter-data-center SFC management. In the example of Figure 8, shown below, there is a central data center (Central DC) and multiple local data centers (Local DC#1, #2, #3) that are deployed in a geographically distributed manner. All of the data centers are under a single administrative domain.

The central DC may have some service functions that the local DC needs, such that the local DC needs to chain traffic via the central DC. This could be because:

- o Some SFs are deployed as dedicated hardware appliances, and there is a desire to lower the cost (both CAPEX and OPEX) of deploying such SFs in all data centers.
- o Some SFs are being trialed, introduced or otherwise handle a relatively small amount of traffic. It may be cheaper to manage these SFs in a single central data center and steer packets to the central data center than to manage these SFs in all data centers.

Internet-Draft

hSFC

June 2018

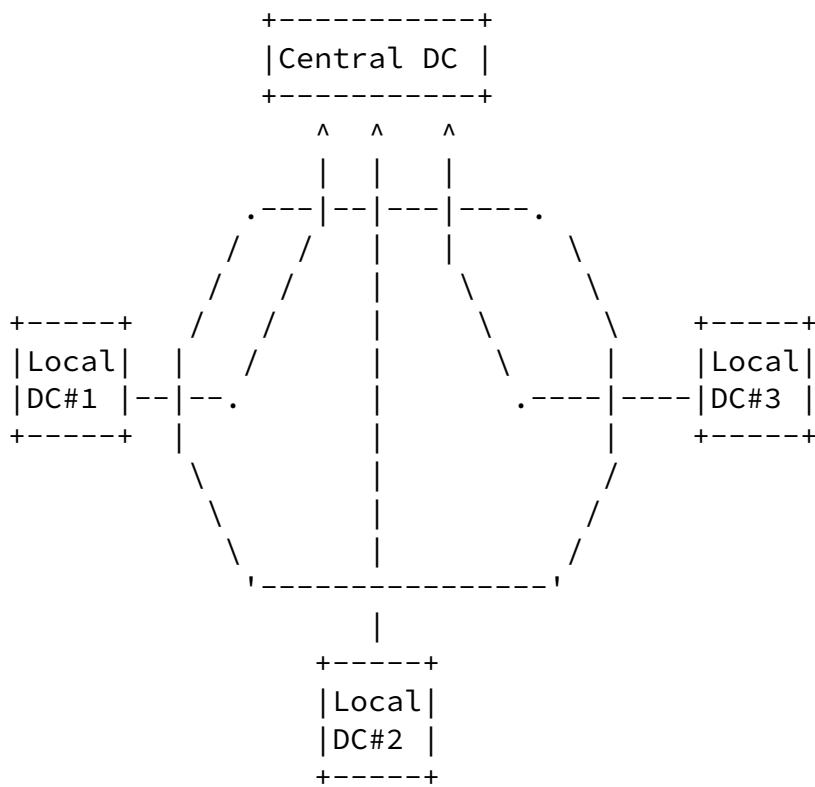

Figure 8: Simplify inter-DC SFC management

For large data center operators, one local DC may have tens of thousands of servers and hundreds of thousands of virtual machines. SFC can be used to manage user traffic. For example, SFC can be used to classify user traffic based on service type, DDoS state, etc.

In such large scale data center, using flat SFC is very complex, requiring a super-controller to configure all data centers. For example, any changes to SFs or SFPs in the central DC (e.g., deploying a new SF) would require updates to all of the SFPs in the local DCs accordingly. Furthermore, requirements for symmetric paths

add additional complexity when flat SFC is used in this scenario.

Conversely, if using hierarchical SFC, each data center can be managed independently to significantly reduce management complexity. SFPs between data centers can represent abstract notions without regard to details within data centers. Independent controllers can be used for the top level (getting packets to pass the correct data centers) and local levels (getting packets to specific SF instances).

Dolson, et al.

Expires December 15, 2018

[Page 25]

Internet-Draft

hSFC

June 2018

Authors' Addresses

David Dolson
Sandvine
Waterloo, ON
Canada

Email: ddolson@acm.org

Shunsuke Homma
NTT, Corp.
3-9-11, Midori-cho
Musashino-shi, Tokyo 180-8585
Japan

Email: homma.shunsuke@lab.ntt.co.jp

Diego R. Lopez
Telefonica I+D
Don Ramon de la Cruz, 82
Madrid 28006
Spain

Phone: +34 913 129 041

Email: diego.r.lopez@telefonica.com

Mohamed Boucadair
Orange
Rennes 35000
France

Email: mohamed.boucadair@orange.com