

TEAS Working Group  
Internet Draft  
Intended status: Standards Track

Xufeng Liu  
Volta Networks  
Igor Bryskin  
Huawei Technologies  
Vishnu Pavan Beeram  
Tarek Saad  
Juniper Networks  
Himanshu Shah  
Ciena  
Oscar Gonzalez De Dios  
Telefonica

Expires: December 19, 2019

June 19, 2019

**YANG Data Model for Traffic Engineering (TE) Topologies  
draft-ietf-teas-yang-te-topo-22**

Status of this Memo

This Internet-Draft is submitted in full conformance with the provisions of [BCP 78](#) and [BCP 79](#).

Internet-Drafts are working documents of the Internet Engineering Task Force (IETF), its areas, and its working groups. Note that other groups may also distribute working documents as Internet-Drafts.

Internet-Drafts are draft documents valid for a maximum of six months and may be updated, replaced, or obsoleted by other documents at any time. It is inappropriate to use Internet-Drafts as reference material or to cite them other than as "work in progress."

The list of current Internet-Drafts can be accessed at <http://www.ietf.org/ietf/1id-abstracts.txt>

The list of Internet-Draft Shadow Directories can be accessed at <http://www.ietf.org/shadow.html>

This Internet-Draft will expire on December 19, 2019.

Copyright Notice

Copyright (c) 2019 IETF Trust and the persons identified as the document authors. All rights reserved.

This document is subject to [BCP 78](#) and the IETF Trust's Legal Provisions Relating to IETF Documents



(<http://trustee.ietf.org/license-info>) in effect on the date of publication of this document. Please review these documents carefully, as they describe your rights and restrictions with respect to this document. Code Components extracted from this document must include Simplified BSD License text as described in Section 4.e of the Trust Legal Provisions and are provided without warranty as described in the Simplified BSD License.

Abstract

This document defines a YANG data model for representing, retrieving and manipulating Traffic Engineering (TE) Topologies. The model serves as a base model that other technology specific TE Topology models can augment.

Conventions used in this document

The key words "MUST", "MUST NOT", "REQUIRED", "SHALL", "SHALL NOT", "SHOULD", "SHOULD NOT", "RECOMMENDED", "NOT RECOMMENDED", "MAY", and "OPTIONAL" in this document are to be interpreted as described in [BCP 14](#) [[RFC2119](#)] [[RFC8174](#)] when, and only when, they appear in all capitals, as shown here.

Table of Contents

- [1. Introduction.....3](#)
- [1.1. Terminology.....4](#)
- [1.2. Tree Structure.....4](#)
- [1.3. Prefixes in Data Node Names.....5](#)
- [2. Characterizing TE Topologies.....5](#)
- [3. Modeling Abstractions and Transformations.....7](#)
- [3.1. TE Topology.....7](#)
- [3.2. TE Node.....7](#)
- [3.3. TE Link.....8](#)
- [3.4. Transitional TE Link for Multi-Layer Topologies.....8](#)
- [3.5. TE Link Termination Point \(LTP\).....10](#)
- [3.6. TE Tunnel Termination Point \(TTP\).....10](#)
- [3.7. TE Node Connectivity Matrix.....11](#)
- [3.8. TTP Local Link Connectivity List \(LLCL\).....11](#)
- [3.9. TE Path.....11](#)
- [3.10. TE Inter-Layer Lock.....12](#)
- [3.11. Underlay TE topology.....13](#)
- [3.12. Overlay TE topology.....13](#)
- [3.13. Abstract TE topology.....13](#)
- [4. Model Applicability.....14](#)
- [4.1. Native TE Topologies.....14](#)



4.2.	Customized TE Topologies.....	16
4.3.	Merging TE Topologies Provided by Multiple Providers.....	19
4.4.	Dealing with Multiple Abstract TE Topologies Provided by the Same Provider.....	22
5.	Modeling Considerations.....	25
5.1.	Network topology building blocks.....	25
5.2.	Technology agnostic TE Topology model.....	25
5.3.	Model Structure.....	26
5.4.	Topology Identifiers.....	27
5.5.	Generic TE Link Attributes.....	27
5.6.	Generic TE Node Attributes.....	28
5.7.	TED Information Sources.....	29
5.8.	Overlay/Underlay Relationship.....	30
5.9.	Templates.....	31
5.10.	Scheduling Parameters.....	32
5.11.	Notifications.....	33
6.	Guidance for Writing Technology Specific TE Topology Augmentations .....	33
7.	TE Topology YANG Module.....	46
8.	Security Considerations.....	92
9.	IANA Considerations.....	94
10.	References.....	95
10.1.	Normative References.....	95
10.2.	Informative References.....	96
11.	Acknowledgments.....	100
Appendix A.	Complete Model Tree Structure.....	101
Appendix B.	Companion YANG Model for Non-NMDA Compliant Implementations.....	163
Appendix C.	Example: YANG Model for Technology Specific Augmentations .....	172
	Contributors.....	210
	Authors' Addresses.....	210

## 1. Introduction

The Traffic Engineering Database (TED) is an essential component of Traffic Engineered (TE) systems that are based on MPLS-TE [[RFC2702](#)] and GMPLS [[RFC3945](#)]. The TED is a collection of all TE information about all TE nodes and TE links in the network. The TE Topology is a schematic arrangement of TE nodes and TE links present in a given TED. There could be one or more TE Topologies present in a given Traffic Engineered system. A TE Topology is the topology on which path computational algorithms are run to compute Traffic Engineered Paths (TE Paths).

This document defines a YANG [[RFC7950](#)] data model for representing and manipulating TE Topologies. This model contains technology



agnostic TE Topology building blocks that can be augmented and used by other technology-specific TE Topology models.

### **1.1. Terminology**

The key words "MUST", "MUST NOT", "REQUIRED", "SHALL", "SHALL NOT", "SHOULD", "SHOULD NOT", "RECOMMENDED", "NOT RECOMMENDED", "MAY", and "OPTIONAL" in this document are to be interpreted as described in [BCP 14](#) [[RFC2119](#)] [[RFC8174](#)] when, and only when, they appear in all capitals, as shown here.

The reader is assumed to be familiar with general body of work captured in currently available TE related RFCs. [[RFC7926](#)] serves as a good starting point for those who may be less familiar with Traffic Engineering related RFCs.

Some of the key terms used in this document are:

TED: The Traffic Engineering Database is a collection of all TE information about all TE nodes and TE links in a given network.

TE-Topology: The TE Topology is a schematic arrangement of TE nodes and TE links in a given TED. It forms the basis for a graph suitable for TE path computations.

Native TE Topology: Native TE Topology is a topology that is native to a given provider network. Native TE topology could be discovered via various routing protocols and/or subscribe/publish techniques. This is the topology on which path computational algorithms are run to compute TE Paths.

Customized TE Topology: Customized TE Topology is a custom topology that is produced by a provider for a given client. This topology typically makes abstractions on the provider's Native TE Topology, and is provided to the client. The client receives the Customized TE Topology, and merges it into the client's Native TE Topology. The client's path computational algorithms aren't typically run on the Customized TE Topology; they are run on the client's Native TE Topology after the merge.

### **1.2. Tree Structure**

A simplified graphical representation of the data model is presented in [Appendix A](#). of this document. The tree format defined in [[RFC8340](#)] is used for the YANG data model tree representation.





### 1.3. Prefixes in Data Node Names

In this document, names of data nodes and other data model objects are prefixed using the standard prefix associated with the corresponding YANG imported modules, as shown in Table 1.

Prefix	YANG module	Reference
yang	ietf-yang-types	[RFC6991]
inet	ietf-inet-types	[RFC6991]
nw	ietf-network	[RFC6991]
nt	ietf-network-topology	[RFC8345]
te-types	ietf-te-types	[I-D.ietf-teas-yang-te-types]

Table 1: Prefixes and corresponding YANG modules

## 2. Characterizing TE Topologies

The data model proposed by this document takes the following characteristics of TE Topologies into account:

- TE Topology is an abstract control-plane representation of the data-plane topology. Hence attributes specific to the data-plane must make their way into the corresponding TE Topology modeling. The TE Topology comprises of dynamic auto-discovered data as well as fairly static data associated with data-plane nodes and links. The dynamic data may change frequently, such as unreserved bandwidth available on data-plane links. The static data rarely changes, such as layer network identification, switching and adaptation capabilities and limitations, fate sharing, and administrative colors. It is possible for a single TE Topology to encompass TE information at multiple switching layers.
- TE Topologies are protocol independent. Information about topological elements may be learnt via link-state protocols, but the topology can exist without being dependent on any particular protocol.
- TE Topology may not be congruent to the routing topology in a given TE System. The routing topology is constructed based on routing adjacencies. There isn't always a one-to-one association between a TE-link and a routing adjacency. For example, the presence of a TE link between a pair of nodes doesn't necessarily imply the existence of a routing-adjacency between these nodes. To



learn more, see [[I-D.ietf-teas-te-topo-and-tunnel-modeling](#)] and [[I-D.ietf-teas-yang-13-te-topo](#)].

- Each TE Topological element has at least one information source associated with it. In some scenarios, there could be more than one information source associated with any given topological element.
- TE Topologies can be hierarchical. Each node and link of a given TE Topology can be associated with respective underlay topology. This means that each node and link of a given TE Topology can be associated with an independent stack of supporting TE Topologies.
- TE Topologies can be customized. TE topologies of a given network presented by the network provider to its client could be customized on per-client request basis. This customization could be performed by provider, by client or by provider/client negotiation. The relationship between a customized topology and provider's native topology could be captured as hierarchical (overlay-underlay), but otherwise the two topologies are decoupled from each other. A customized topology is presented to the client, while provider's native topology is known in its entirety to the provider itself.

### 3. Modeling Abstractions and Transformations

```

| +---+
| | | TE Node  \ / TTP  o LTP
| +---+
|
| ----- TE Link
| ***** Node Connectivity Matrix,
| TTP Local Link Connectivity
| @@@@ TE Tunnel
0-----

```

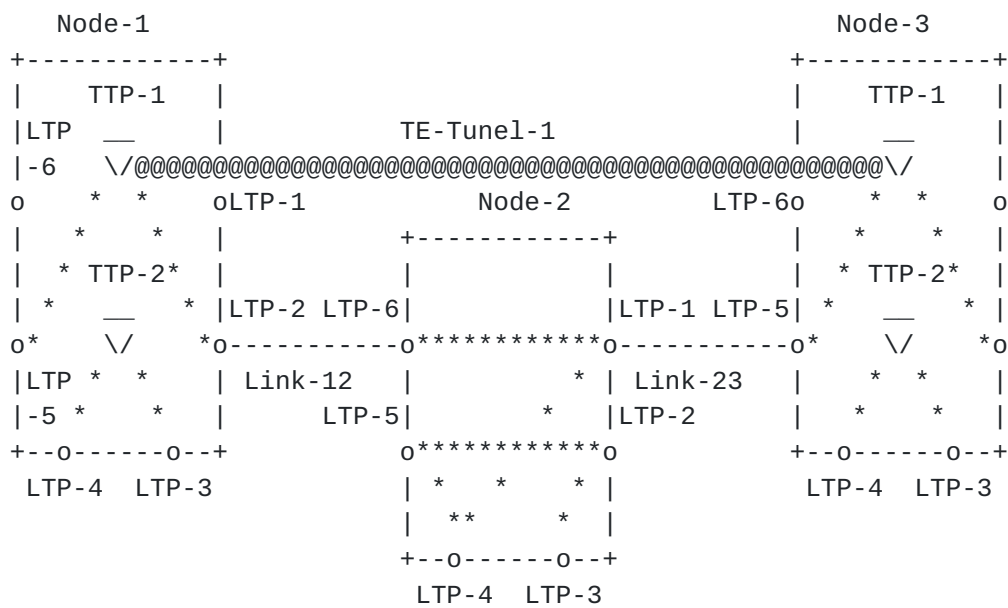

Figure 1: TE Topology Modeling Abstractions

#### 3.1. TE Topology

TE topology is a traffic engineering representation of one or more layers of network topologies. TE topology is comprised of TE nodes (TE graph vertices) interconnected via TE links (TE graph edges). A TE topology is mapped to a TE graph.

#### 3.2. TE Node

TE node is an element of a TE topology, presented as a vertex on TE graph. TE node represents one or several nodes, or a fraction of a node, which can be a switch or router that is physical or virtual. TE node belongs to and is fully defined in exactly one TE topology. TE node is assigned a unique ID within the TE topology scope. TE node attributes include information related to the data plane aspects of



the associated node(s) (e.g. connectivity matrix), as well as configuration data (such as TE node name). A given TE node can be reached on the TE graph over one of TE links terminated by the TE node.

Multi-layer TE nodes providing switching functions at multiple network layers are an example where a physical node can be decomposed into multiple logical TE nodes, which are fractions of the physical node. Some of these (logical) TE nodes may reside in the client layer TE topology while the remaining TE nodes belong to the server layer TE topology.

In Figure 1, Node-1, Node-2, and Node-3 are TE nodes.

### **3.3. TE Link**

TE link is an element of a TE topology, presented as an edge on TE graph. The arrows on an edge indicate one or both directions of the TE link. When there are a pair of parallel links of opposite directions, an edge without arrows is also used. TE link represents one or several (physical) links or a fraction of a link. TE link belongs to and is fully defined in exactly one TE topology. TE link is assigned a unique ID within the TE topology scope. TE link attributes include parameters related to the data plane aspects of the associated link(s) (e.g. unreserved bandwidth, resource maps/pools, etc.), as well as the configuration data (such as remote node/link IDs, SRLGs, administrative colors, etc.). TE link is connected to TE node, terminating the TE link via exactly one TE link termination point (LTP).

In Figure 1, Link-12 and Link-23 are TE links.

### **3.4. Transitional TE Link for Multi-Layer Topologies**

Networks are typically composed of multiple network layers where one or multiple signals in the client layer network can be multiplexed and encapsulated into a server layer signal [[RFC5212](#)] [[G.805](#)]. The server layer signal can be carried in the server layer network across multiple nodes until the server layer signal is terminated and the client layer signals reappear in the node that terminates the server layer signal. Examples of multi-layer networks are: IP over MPLS over Ethernet, low order Optical Data Unit-k (ODUk) signals multiplexed into a high order ODU1 (1>k) carried over an Optical Channel (OCh) signal in an optical transport network as defined in [[G.872](#)] and [[G.709](#)].



TE links as defined in [Section 3.3](#). can be used to represent links within a network layer. In case of a multi-layer network, TE nodes and TE links only allow representation of each network layer as a separate TE topology. Each of these single layer TE topologies would be isolated from their client and their server layer TE topology, if present. The highest and the lowest network layer in the hierarchy only have a single adjacent layer below or above, respectively. Multiplexing of client layer signals and encapsulating them into a server layer signal requires a function that is provided inside a node (typically realized in hardware). This function is also called layer transition.

One of the key requirements for path computation is to be able to calculate a path between two endpoints across a multi-layer network based on the TE topology representing this multi-layer network. This means that an additional TE construct is needed that represents potential layer transitions in the multi-layer TE-topology that connects the TE-topologies representing each separate network layer. The so-called transitional TE link is such a construct and it represents the layer transition function residing inside a node that is decomposed into multiple logical nodes that are represented as TE nodes (see also the transitional link definition in [\[G.8080\]](#) for the optical transport network). Hence, a transitional TE link connects a client layer node with a server layer node. A TE link as defined in 3.3. has LTPs of exactly the same kind on each link end whereas the transitional TE link has client layer LTPs on the client side of the transitional link and in most cases a single server layer LTP on the server side. It should be noted that transitional links are a helper construct in the multi-layer TE topology and they only exist as long as they are not in use, as they represent potential connectivity. When the server layer trail has been established between the server layer LTP of two transitional links in the server layer network, the resulting client layer link in the data plane will be represented as a normal TE link in the client layer topology. The transitional TE links will re-appear when the server layer trail has been torn down.





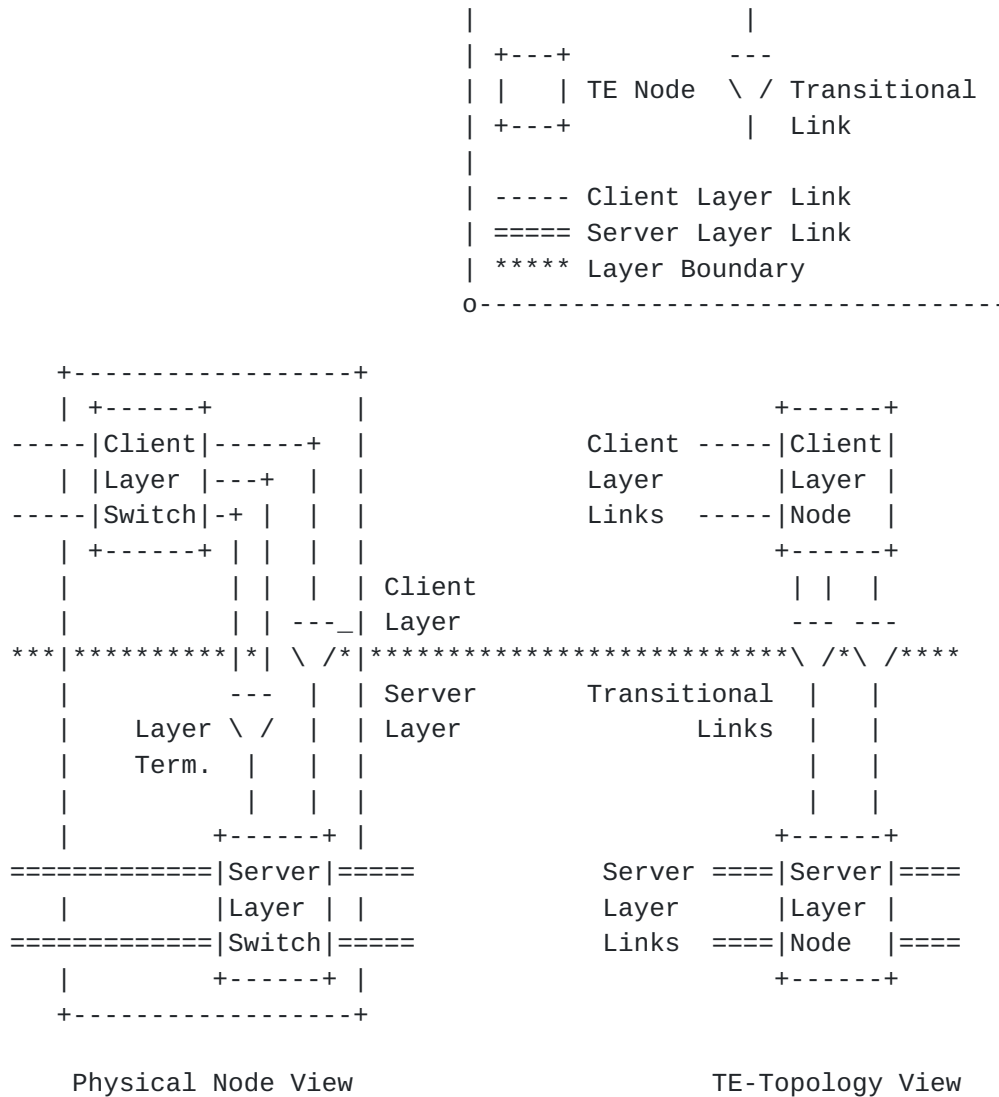

Figure 2: Modeling a Multi-Layer Node (Dual-Layer Example)

**3.5. TE Link Termination Point (LTP)**

TE link termination point (LTP) is a conceptual point of connection of a TE node to one of the TE links, terminated by the TE node. Cardinality between an LTP and the associated TE link is 1:0..1.

In Figure 1, Node-2 has six LTPs: LTP-1 to LTP-6.

**3.6. TE Tunnel Termination Point (TTP)**

TE tunnel termination point (TTP) is an element of TE topology representing one or several of potential transport service termination points (i.e. service client adaptation points such as



WDM/OCh transponder). TTP is associated with (hosted by) exactly one TE node. TTP is assigned a unique ID within the TE node scope. Depending on the TE node's internal constraints, a given TTP hosted by the TE node could be accessed via one, several or all TE links terminated by the TE node.

In Figure 1, Node-1 has two TTPs: TTP-1 and TTP-2.

### **3.7. TE Node Connectivity Matrix**

TE node connectivity matrix is a TE node's attribute describing the TE node's switching limitations in a form of valid switching combinations of the TE node's LTPs (see below). From the point of view of a potential TE path arriving at the TE node at a given inbound LTP, the node's connectivity matrix describes valid (permissible) outbound LTPs for the TE path to leave the TE node from.

In Figure 1, the connectivity matrix on Node-2 is:

```
{<LTP-6, LTP-1>, <LTP-5, LTP-2>, <LTP-5, LTP-4>, <LTP-4, LTP-1>, <LTP-3, LTP-2>}
```

### **3.8. TTP Local Link Connectivity List (LLCL)**

TTP Local Link Connectivity List (LLCL) is a List of TE links terminated by the TTP hosting TE node (i.e. list of the TE link LTPs), which the TTP could be connected to. From the point of view of a potential TE path, LLCL provides a list of valid TE links the TE path needs to start/stop on for the connection, taking the TE path, to be successfully terminated on the TTP in question.

In Figure 1, the LLCL on Node-1 is:

```
{<TTP-1, LTP-5>, <TTP-1, LTP-2>, <TTP-2, LTP-3>, <TTP-2, LTP4>}
```

### **3.9. TE Path**

TE path is an ordered list of TE links and/or TE nodes on the TE topology graph, inter-connecting a pair of TTPs to be taken by a potential connection. TE paths, for example, could be a product of successful path computation performed for a given transport service.

In Figure 1, the TE Path for TE-Tunnel-1 is:

```
{Node-1:TTP-1, Link-12, Node-2, Link-23, Node-3:TTP1}
```



**3.10. TE Inter-Layer Lock**

TE inter-layer lock is a modeling concept describing client-server layer adaptation relationships and hence important for the multi-layer traffic engineering. It is an association of M client layer LTPs and N server layer TTPs, within which data arriving at any of the client layer LTPs could be adopted onto any of the server layer TTPs. TE inter-layer lock is identified by inter-layer lock ID, which is unique across all TE topologies provided by the same provider. The client layer LTPs and the server layer TTPs associated within a given TE inter-layer lock are annotated with the same inter-layer lock ID attribute.

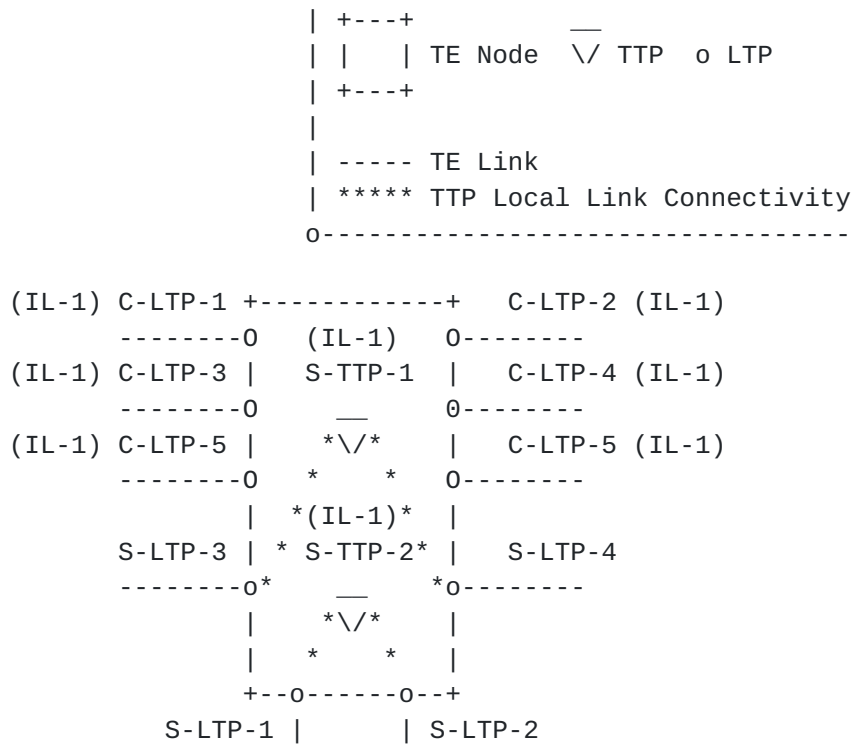

Figure 3: TE Inter-Layer Lock ID Associations

On the picture above a TE inter-layer lock with IL\_1 ID associates 6 client layer LTPs (C-LTP-1 - C-LTP-6) with two server layer TTPs (S-TTP-1 and S-TTP-2). They all have the same attribute - TE inter-layer lock ID: IL-1, which is the only thing that indicates the association. A given LTP may have 0, 1 or more inter-layer lock IDs. In the latter case this means that the data arriving at the LTP may be adopted onto any of TTPs associated with all specified inter-layer locks. For example, C-LTP-1 could have two inter-layer lock IDs - IL-1 and IL-2. This would mean that C-LTP-1 for adaptation purposes could use not just TTPs associated with inter-layer lock IL-1 (i.e.



S-TTP-1 and S-TTP-2 on the picture), but any of TTPs associated with inter-layer lock IL-2 as well. Likewise, a given TTP may have one or more inter-layer lock IDs, meaning that it can offer the adaptation service to any of client layer LTPs with inter-layer lock ID matching one of its own. Additionally, each TTP has an attribute - Unreserved Adaptation Bandwidth, which announces its remaining adaptation resources sharable between all potential client LTPs.

LTPs and TTPs associated within the same TE inter-layer lock may be hosted by the same (hybrid, multi-layer) TE node or multiple TE nodes located in the same or separate TE topologies. The latter is especially important since TE topologies of different layer networks could be modeled by separate augmentations of the basic (common to all layers) TE topology model.

### **3.11. Underlay TE topology**

Underlay TE topology is a TE topology that serves as a base for constructing of overlay TE topologies

### **3.12. Overlay TE topology**

Overlay TE topology is a TE topology constructed based on one or more underlay TE topologies. Each TE node of the overlay TE topology represents an arbitrary segment of an underlay TE topology; each TE link of the overlay TE topology represents an arbitrary TE path in one of the underlay TE topologies. The overlay TE topology and the supporting underlay TE topologies may represent distinct layer networks (e.g. OTN/ODUK and WDM/OCh respectively) or the same layer network.

### **3.13. Abstract TE topology**

Abstract TE topology is a topology that contains abstract topological elements (nodes, links, tunnel termination points). Abstract TE topology is an overlay TE topology created by a topology provider and customized for a topology provider's client based on one or more of the provider's native TE topologies (underlay TE topologies), the provider's policies and the client's preferences. For example, a first level topology provider (such as Domain Controller) can create an abstract TE topology for its client (e.g. Multi-Domain Service Coordinator) based on the provider's one or more native TE topologies, local policies/profiles and the client's TE topology configuration requests

Figure 4 shows an example of abstract TE topology.





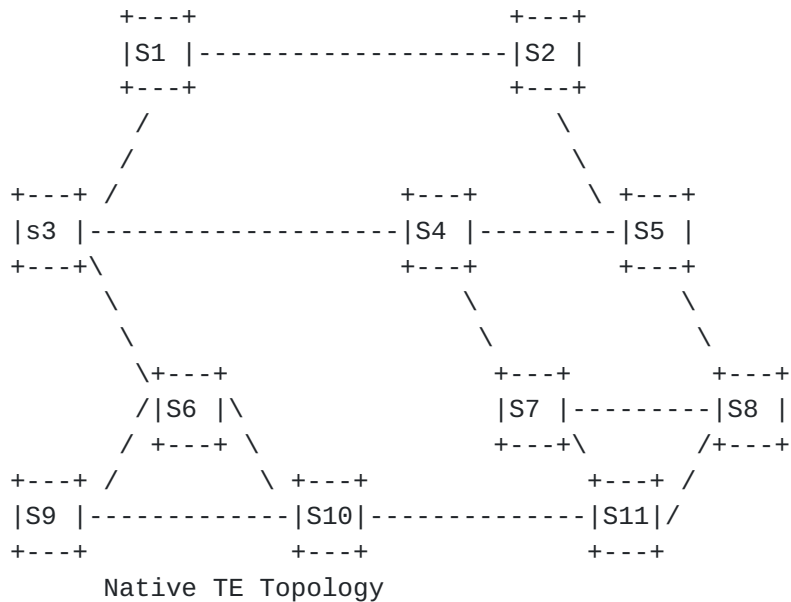
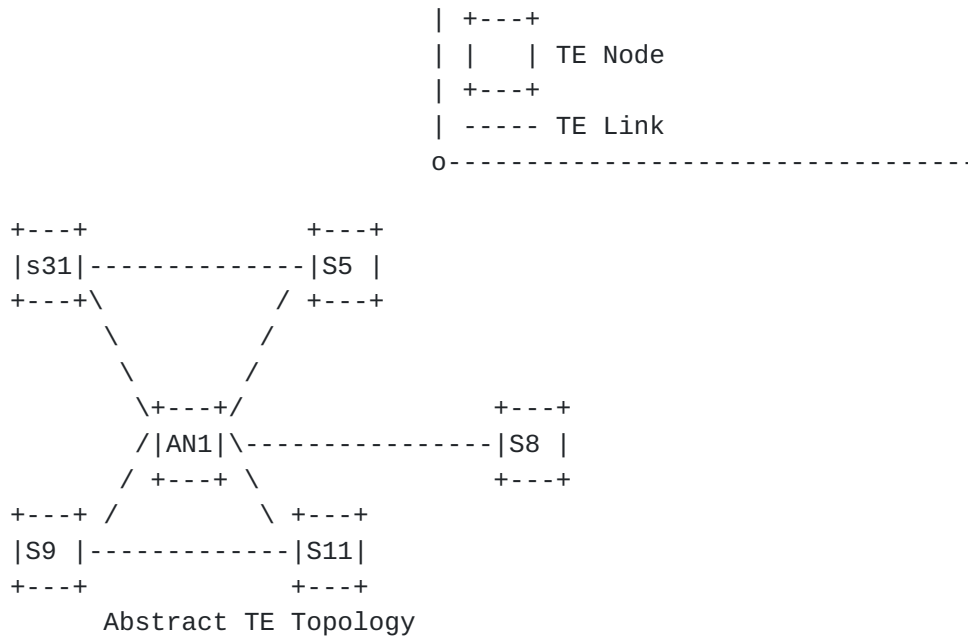

Figure 4: Abstract TE Topology

4. Model Applicability

4.1. Native TE Topologies

The model discussed in this draft can be used to represent and retrieve native TE topologies on a given TE system.



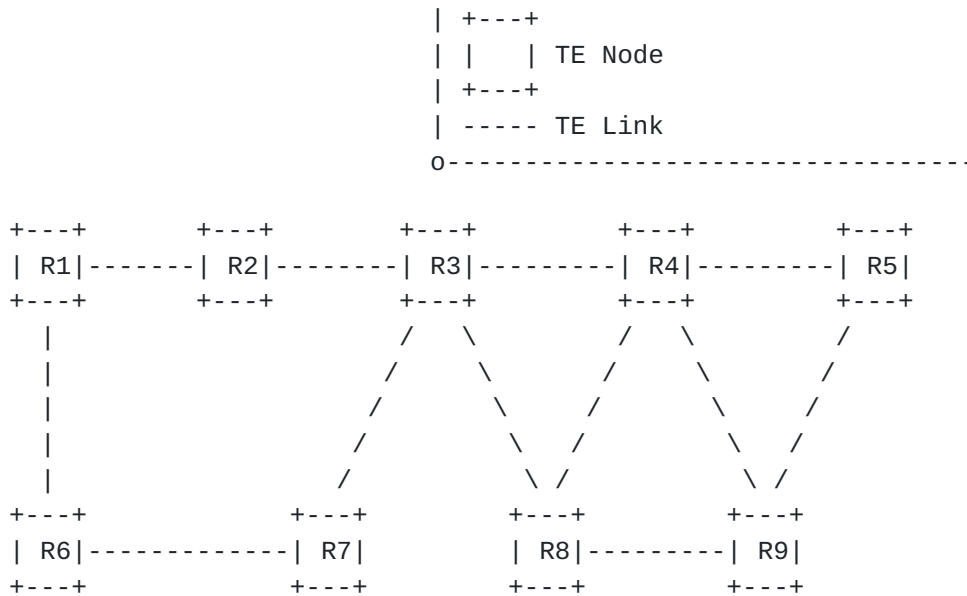

Figure 5a: Example Network Topology

Consider the network topology depicted in Figure 5a. R1 .. R9 are nodes representing routers. An implementation MAY choose to construct a native TE Topology using all nodes and links present in the given TED as depicted in Figure 5b. The data model proposed in this document can be used to retrieve/represent this TE topology.

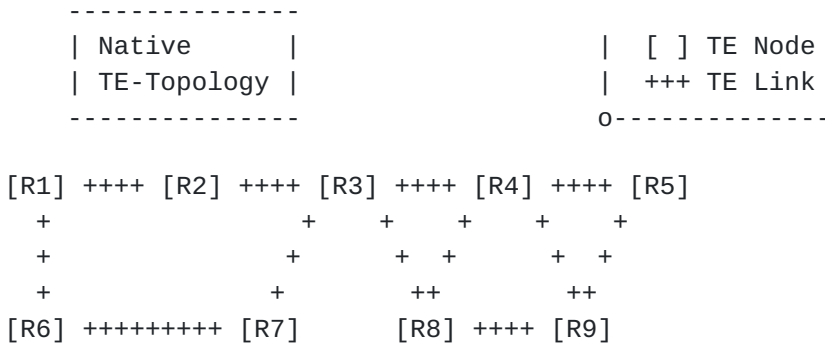

Figure 5b: Native TE Topology as seen on Node R3

Consider the case of the topology being split in a way that some nodes participate in OSPF-TE while others participate in ISIS-TE (Figure 6a). An implementation MAY choose to construct separate TE Topologies based on the information source. The native TE Topologies constructed using only nodes and links that were learnt via a specific information source are depicted in Figure 6b. The data model proposed in this document can be used to retrieve/represent these TE topologies.



Similarly, the data model can be used to represent/retrieve a TE Topology that is constructed using only nodes and links that belong to a particular technology layer. The data model is flexible enough to retrieve and represent many such native TE Topologies.

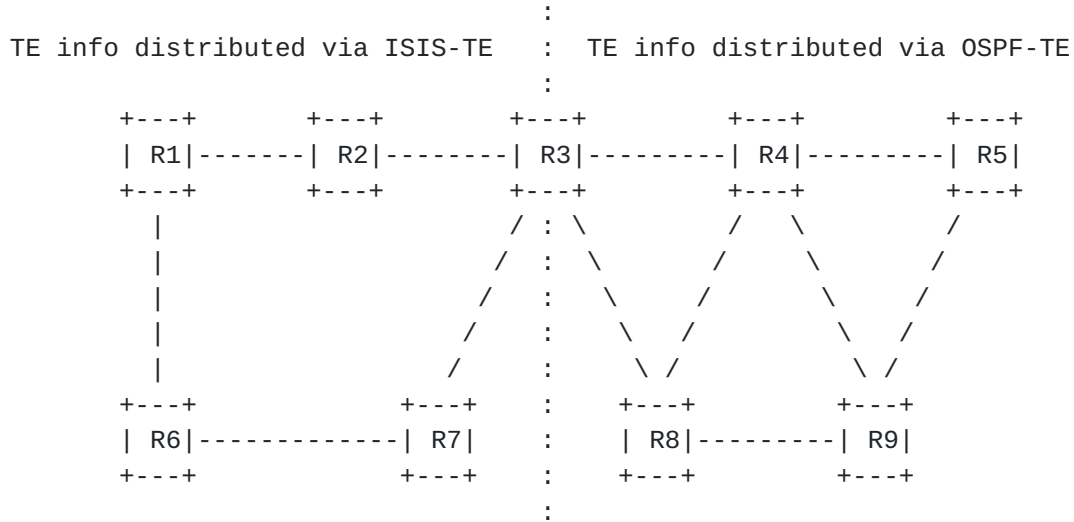

Figure 6a: Example Network Topology

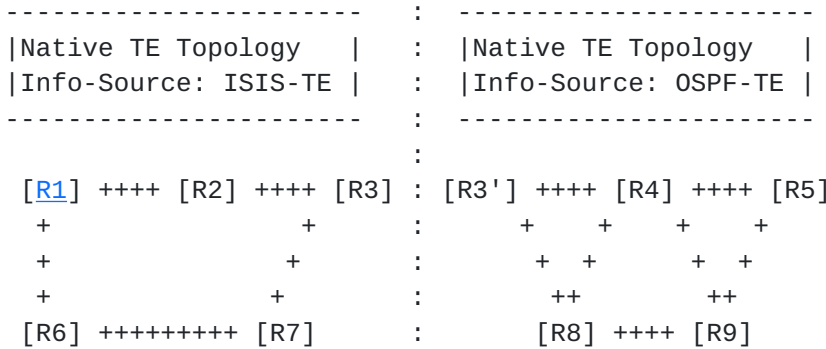

Figure 6b: Native TE Topologies as seen on Node R3

#### 4.2. Customized TE Topologies

Customized TE topology is a topology that was modified by the provider to honor a particular client's requirements or preferences. The model discussed in this draft can be used to represent, retrieve and manipulate customized TE Topologies. The model allows the provider to present the network in abstract TE Terms on a per client



basis. These customized topologies contain sufficient information for the path computing client to select paths according to its policies.

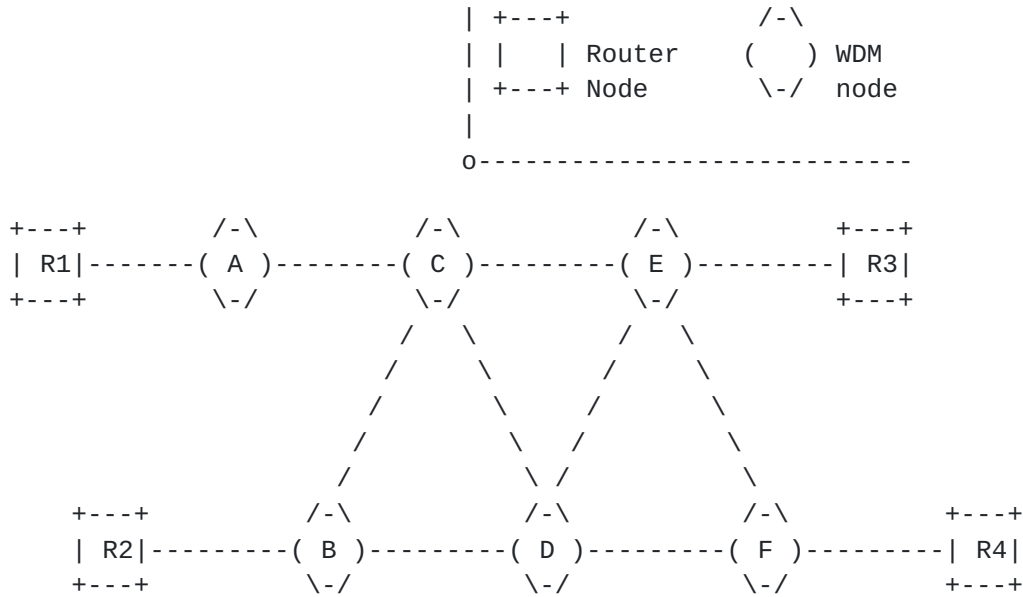

Figure 7: Example packet optical topology

Consider the network topology depicted in Figure 7. This is a typical packet optical transport deployment scenario where the WDM layer network domain serves as a Server Network Domain providing transport connectivity to the packet layer network Domain (Client Network Domain). Nodes R1, R2, R3 and R4 are IP routers that are connected to an Optical WDM transport network. A, B, C, D, E and F are WDM nodes that constitute the Server Network Domain.

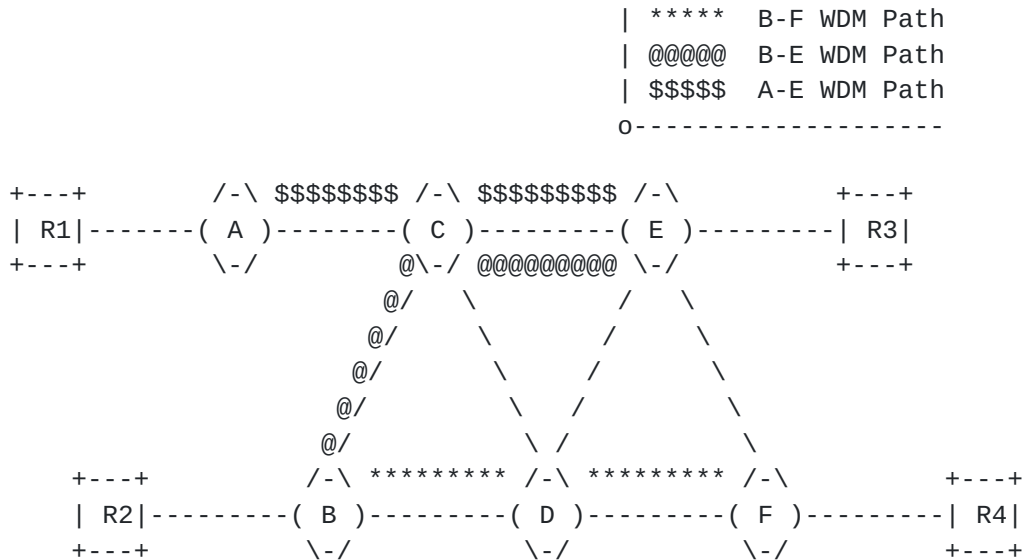





Figure 8a: Paths within the provider domain

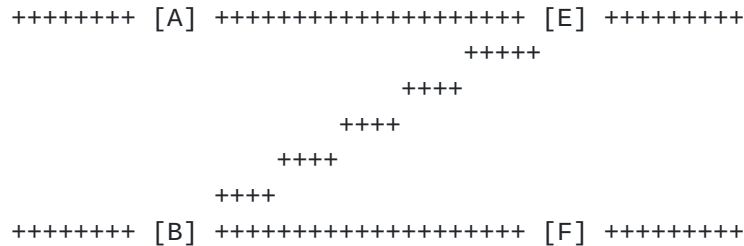

Figure 8b: Customized TE Topology provided to the Client

The goal here is to augment the Client TE Topology with a customized TE Topology provided by the WDM network. Given the availability of the paths A-E, B-F and B-E (Figure 8a), a customized TE Topology as depicted in Figure 8b is provided to the Client. This customized TE Topology is merged with the Client's Native TE Topology and the resulting topology is depicted in Figure 8c.

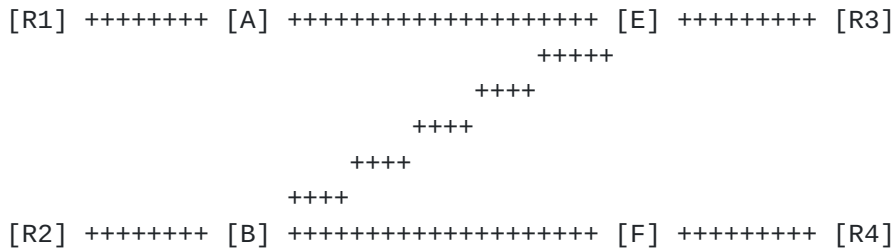

Figure 8c: Customized TE Topology merged with the Client's Native TE Topology

The data model proposed in this document can be used to retrieve/represent/manipulate the customized TE Topology depicted in Figure 8b.

A customized TE topology is not necessarily an abstract TE topology. The provider may produce, for example, an abstract TE topology of certain type (e.g. single-abstract-node-with-connectivity-matrix topology, a border-nodes-connected-via-mesh-of-abstract-links topology, etc.) and expose it to all/some clients in expectation that the clients will use it without customization.

On the other hand, a client may request a customized version of the provider's native TE topology (e.g. by requesting removal of TE links



which belong to certain layers, are too slow, not protected and/or have a certain affinity). Note that the resulting TE topology will not be abstract (because it will not contain abstract elements), but customized (modified upon client's instructions).

The client ID field in the TE topology identifier ([Section 5.4.](#) ) indicates which client the TE topology is customized for. Although an authorized client MAY receive a TE topology with the client ID field matching some other client, the client can customize only TE topologies with the client ID field either 0 or matching the ID of the client in question. If the client starts reconfiguration of a topology its client ID will be automatically set in the topology ID field for all future configurations and updates wrt. the topology in question.

The provider MAY tell the client that a given TE topology cannot be re-negotiated, by setting its own (provider's) ID in the client ID field of the topology ID.

Even though this data model allows to access TE topology information across clients, implementations MAY restrict access for particular clients to particular data fields. The Network Configuration Access Control Model (NACM) [[RFC8341](#)] provides such a mechanism.

#### **4.3. Merging TE Topologies Provided by Multiple Providers**

A client may receive TE topologies provided by multiple providers, each of which managing a separate domain of multi-domain network. In order to make use of said topologies, the client is expected to merge the provided TE topologies into one or more client's native TE topologies, each of which homogeneously representing the multi-domain network. This makes it possible for the client to select end-to-end TE paths for its services traversing multiple domains.

In particular, the process of merging TE topologies includes:

- Identifying neighboring domains and locking their topologies horizontally by connecting their inter-domain open-ended TE links;
- Renaming TE node, link, and SRLG IDs to ones allocated from a separate name space; this is necessary because all TE topologies are considered to be, generally speaking, independent with a possibility of clashes among TE node, link or SRLG IDs;
- Locking, vertically, TE topologies associated with different layer networks, according to provided topology inter-layer locks; this is to facilitate inter-layer path computations across multiple TE topologies provided by the same topology provider.

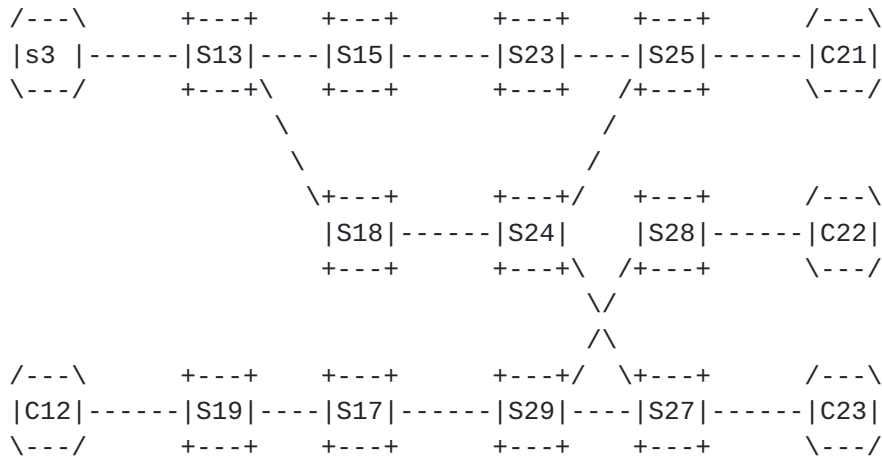

Domain 1 TE Topology

Domain 2 TE Topology

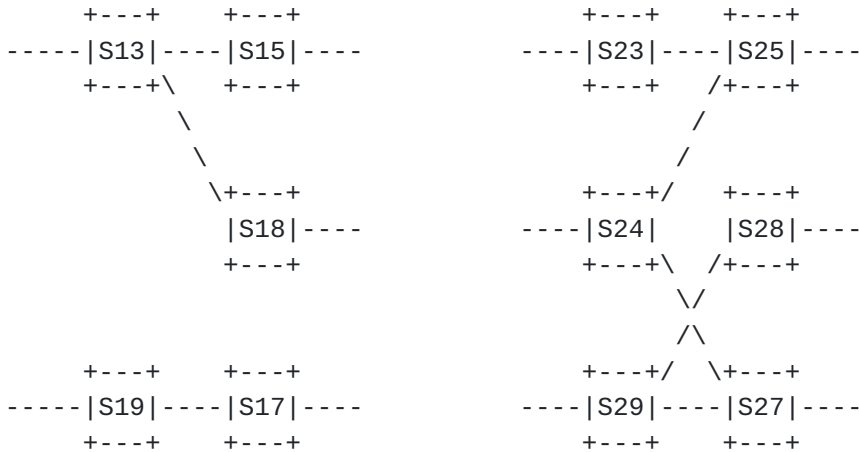

Figure 9: Merging Domain TE Topologies

Figure 9 illustrates the process of merging, by the client, of TE topologies provided by the client's providers. In the Figure, each of the two providers caters to the client (abstract or native) TE topology, describing the network domain under the respective provider's control. The client, by consulting the attributes of the inter-domain TE links - such as inter-domain plug IDs or remote TE node/link IDs (as defined by the TE Topology model) - is able to determine that:

- a) the two domains are adjacent and are inter-connected via three inter-domain TE links, and;



- b) each domain is connected to a separate customer site, connecting the left domain in the Figure to customer devices C-11 and C-12, and the right domain to customer devices C-21, C-22 and C-23.

Therefore, the client inter-connects the open-ended TE links, as shown on the upper part of the Figure.

As mentioned, one way to inter-connect the open-ended inter-domain TE links of neighboring domains is to mandate the providers to specify remote nodeID/linkID attribute in the provided inter-domain TE links. This, however, may prove to be not flexible. For example, the providers may not know the respective remote nodeIDs/ linkIDs. More importantly, this option does not allow for the client to mix-n-match multiple (more than one) topologies catered by the same providers (see below). Another, more flexible, option to resolve the open-ended inter-domain TE links is by annotating them with the inter-domain plug ID attribute. Inter-domain plug ID is a network-wide unique number that identifies on the network a connectivity supporting a given inter-domain TE link. Instead of specifying remote node ID/link ID, an inter-domain TE link may provide a non-zero inter-domain plug ID. It is expected that two neighboring domain TE topologies (provided by separate providers) will have each at least one open-ended inter-domain TE link with an inter-domain plug ID matching to one provided by its neighbor. For example, the inter-domain TE link originating from node S15 of the Domain 1 TE topology (Figure 9) and the inter-domain TE link coming from node S23 of Domain 2 TE topology may specify matching inter-domain plug ID (e.g. 175344). This allows for the client to identify adjacent nodes in the separate neighboring TE topologies and resolve the inter-domain TE links connecting them regardless of their respective nodeIDs/linkIDs (which, as mentioned, could be allocated from independent name spaces). Inter-domain plug IDs may be assigned and managed by a central network authority. Alternatively, inter-domain plug IDs could be dynamically auto-discovered (e.g. via LMP protocol).

Furthermore, the client renames the TE nodes, links and SRLGs offered in the abstract TE topologies by assigning to them IDs allocated from a separate name space managed by the client. Such renaming is necessary, because the two abstract TE topologies may have their own name spaces, generally speaking, independent one from another; hence, ID overlaps/clashes are possible. For example, both TE topologies have TE nodes named S7, which, after renaming, appear in the merged TE topology as S17 and S27, respectively.

Once the merging process is complete, the client can use the merged TE topology for path computations across both domains, for example, to compute a TE path connecting C-11 to C-23.





4.4. Dealing with Multiple Abstract TE Topologies Provided by the Same Provider

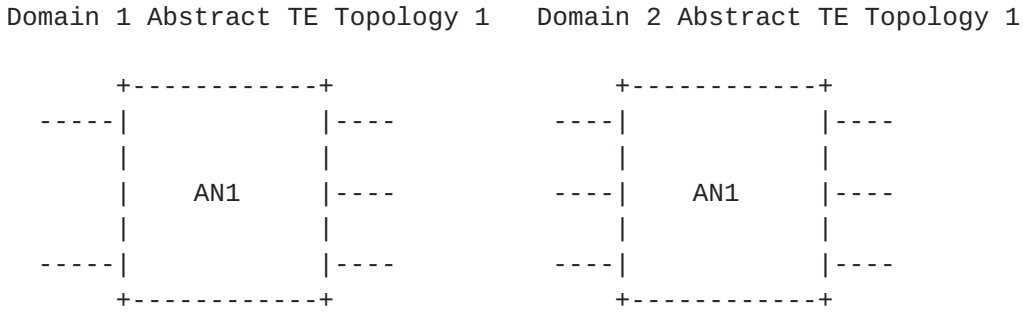
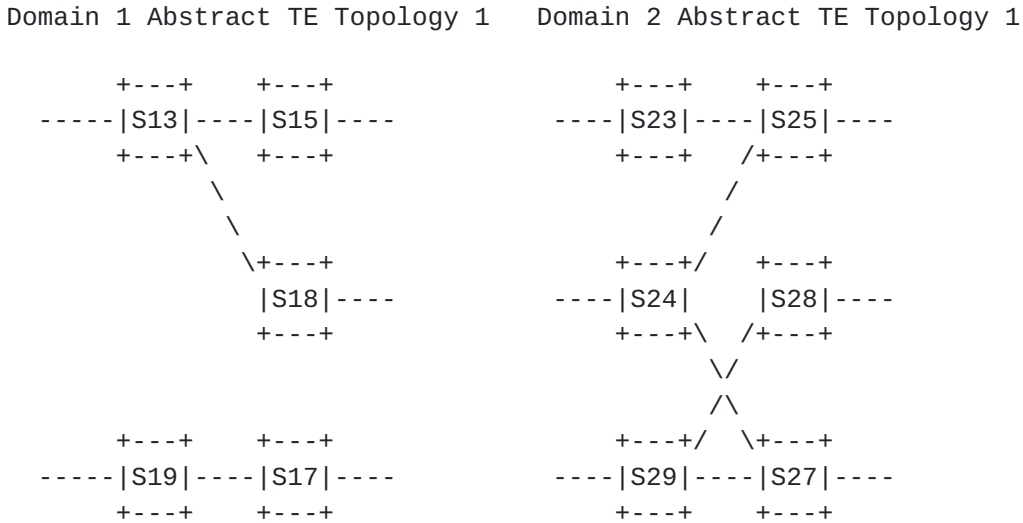

Figure 10: Merging Domain TE Topologies

Based on local configuration, templates and/or policies pushed by the client, a given provider may expose more than one abstract TE topology to the client. For example, one abstract TE topology could be optimized based on a lowest-cost criterion, while another one could be based on best possible delay metrics, while yet another one could be based on maximum bandwidth availability for the client services. Furthermore, the client may request all or some providers to expose additional abstract TE topologies, possibly of a different type and/or optimized differently, as compared to already-provided TE topologies. In any case, the client should be prepared for a provider to offer to the client more than one abstract TE topology.

It should be up to the client (based on the client's local configuration and/or policies conveyed to the client by the client's



clients) to decide how to mix-and-match multiple abstract TE topologies provided by each or some of the providers, as well as how to merge them into the client's native TE topologies. The client also decides how many such merged TE topologies it needs to produce and maintain. For example, in addition to the merged TE topology depicted in the upper part of Figure 9, the client may merge the abstract TE topologies received from the two providers, as shown in Figure 10, into the client's additional native TE topologies, as shown in Figure 11.

Note that allowing for the client mix-n-matching of multiple TE topologies assumes that inter-domain plug IDs (rather than remote nodeID/linkID) option is used for identifying neighboring domains and inter-domain TE link resolution.

Client's Merged TE Topology 2

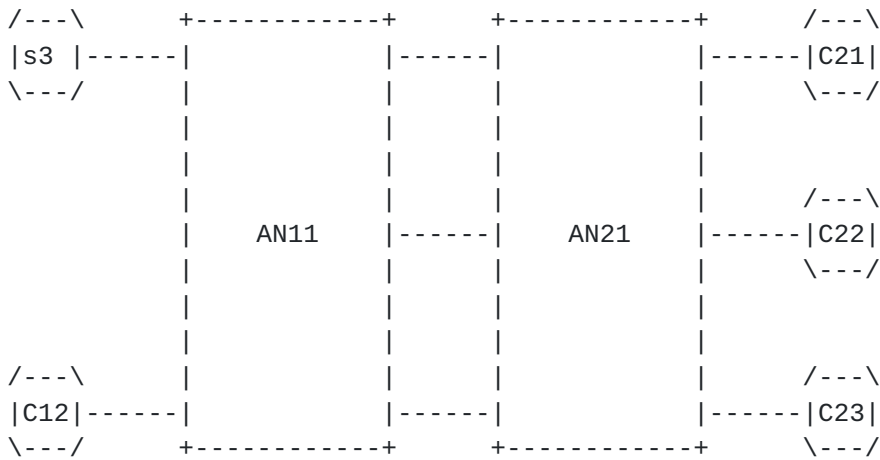

Client's Merged TE Topology 3

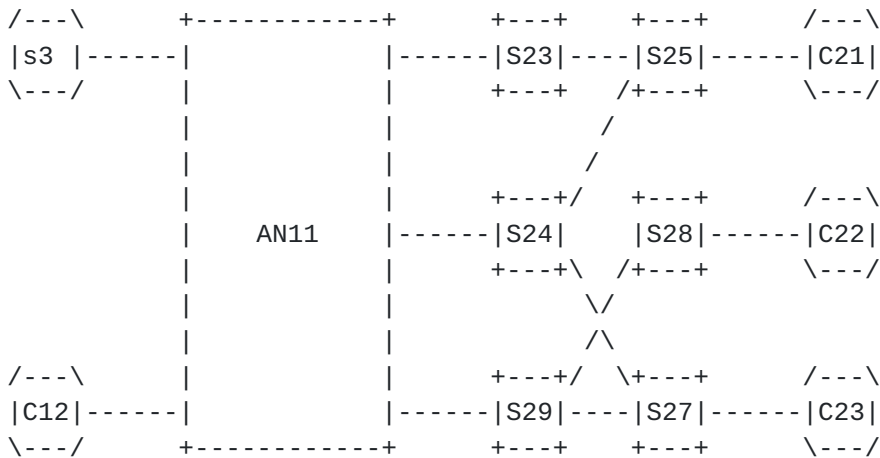

Figure 11: Multiple Native (Merged) Client's TE Topologies

It is important to note that each of the three native (merged) TE topologies could be used by the client for computing TE paths for any of the multi-domain services. The choice as to which topology to use for a given service depends on the service parameters/requirements and the topology's style, optimization criteria and the level of details.



**5. Modeling Considerations**

**5.1. Network topology building blocks**

The network topology building blocks are discussed in [RFC8345]. The TE Topology model proposed in this document augments and uses the ietf-network-topology module defined in [RFC8345].

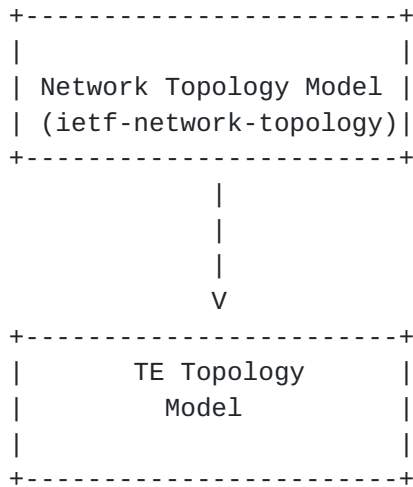

Figure 12: Augmenting the Network Topology Model

**5.2. Technology agnostic TE Topology model**

The TE Topology model proposed in this document is meant to be network technology agnostic. Other technology specific TE Topology models can augment and use the building blocks provided by the proposed model.

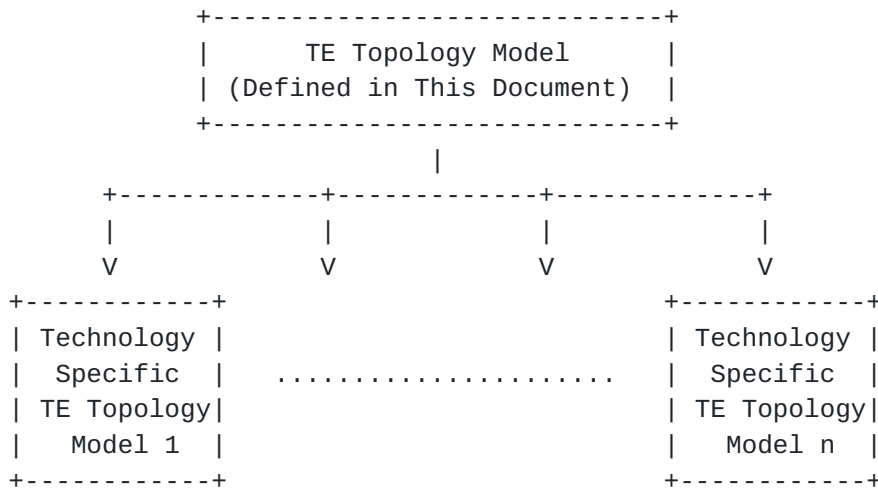

Figure 13: Augmenting the Technology agnostic TE Topology model

### 5.3. Model Structure

The high-level model structure proposed by this document is as shown below:

```

module: ietf-te-topology
augment /nw:networks/nw:network/nw:network-types:
  +--rw te-topology!

augment /nw:networks:
  +--rw te!
    +--rw templates
      +--rw node-template* [name] {template}?
      | .....
      +--rw link-template* [name] {template}?
      .....

augment /nw:networks/nw:network:
  +--rw te-topology-identifier
  | +--rw provider-id?   te-global-id
  | +--rw client-id?    te-global-id
  | +--rw topology-id?  te-topology-id
  +--rw te!
  | .....

augment /nw:networks/nw:network/nw:node:
  +--rw te-node-id?    te-types:te-node-id
  +--rw te!
  | .....
  +--rw tunnel-termination-point* [tunnel-tp-id]
    
```





```

    +--rw tunnel-tp-id    binary
    | .....
    +--rw supporting-tunnel-termination-point* [node-ref tunnel-
tp-ref]
    | .....

```

```

augment /nw:networks/nw:network/nt:link:
  +--rw te!
  | .....

```

```

augment /nw:networks/nw:network/nw:node/nt:termination-point:
  +--rw te-tp-id?    te-types:te-tp-id
  +--rw te!
  | .....

```

**5.4. Topology Identifiers**

The TE-Topology is uniquely identified by a key that has 3 constituents - topology-id, provider-id and client-id. The combination of provider-id and topology-id uniquely identifies a native TE Topology on a given provider. The client-id is used only when Customized TE Topologies come into play; a value of "0" is used as the client-id for native TE Topologies.

```

augment /nw:networks/nw:network:
  +--rw te-topology-identifier
  | +--rw provider-id?    te-global-id
  | +--rw client-id?     te-global-id
  | +--rw topology-id?   te-topology-id
  +--rw te!
  | .....

```

**5.5. Generic TE Link Attributes**

The model covers the definitions for generic TE Link attributes - bandwidth, admin groups, SRLGs, switching capabilities, TE metric extensions etc.

```

+--rw te-link-attributes
  .....
  +--rw admin-status?          te-admin-status
  | .....
  +--rw link-index?           uint64
  +--rw administrative-group?  te-types:admin-groups
  +--rw link-protection-type?  enumeration
  +--rw max-link-bandwidth?    te-bandwidth

```



```

+--rw max-resv-link-bandwidth?          te-bandwidth
+--rw unreserved-bandwidth* [priority]
| .....
+--rw te-default-metric?                 uint32
| .....
+--rw te-srlgs
+--rw te-nsrlgs {nsrlg}?                .....
    
```

**5.6. Generic TE Node Attributes**

The model covers the definitions for generic TE Node attributes.

The definition of a generic connectivity matrix is shown below:

```

+--rw te-node-attributes
.....
+--rw connectivity-matrices
.....
| +--rw connectivity-matrix* [id]
| | +--rw id                uint32
| | +--rw from
| | | +--rw tp-ref?         leafref
| | | +--rw label-restrictions
| | +--rw to
| | | +--rw tp-ref?         leafref
| | | +--rw label-restrictions
| | +--rw is-allowed?      boolean
.....
| | +--rw underlay! {te-topology-hierarchy}?
.....
| | +--rw path-constraints
.....
| | +--rw optimizations
.....
| | +--ro path-properties
.....
    
```

The definition of a TTP Local Link Connectivity List is shown below:

```

+--rw tunnel-termination-point* [tunnel-tp-id]
+--rw tunnel-tp-id          binary
+--rw admin-status?         te-types:te-admin-status
+--rw name?                  string
+--rw switching-capability?  identityref
+--rw encoding?              identityref
+--rw inter-layer-lock-id*   uint32
    
```



```

+--rw protection-type?          Identityref
+--rw client-layer-adaptation
.....
+--rw local-link-connectivities
.....
|  +--rw local-link-connectivity* [link-tp-ref]
|    +--rw link-tp-ref          leafref
|    +--rw label-restrictions
.....
|    +--rw is-allowed?          boolean
|    +--rw underlay {te-topology-hierarchy}?
.....
|    +--rw path-constraints
.....
|    +--rw optimizations
.....
|    +--ro path-properties
.....
+--rw supporting-tunnel-termination-point* [node-ref tunnel-tp-
ref]
    +--rw node-ref              inet:uri
    +--rw tunnel-tp-ref         binary

```

The attributes directly under container connectivity-matrices are the default attributes for all connectivity-matrix entries when the per entry corresponding attribute is not specified. When a per entry attribute is specified, it overrides the corresponding attribute directly under the container connectivity-matrices. The same rule applies to the attributes directly under container local-link-connectivities.

Each TTP (Tunnel Termination Point) MAY be supported by one or more supporting TTPs. If the TE node hosting the TTP in question refers to a supporting TE node, then the supporting TTPs are hosted by the supporting TE node. If the TE node refers to an underlay TE topology, the supporting TTPs are hosted by one or more specified TE nodes of the underlay TE topology.

### **5.7. TED Information Sources**

The model allows each TE topological element to have multiple TE information sources (OSPF-TE, ISIS-TE, BGP-LS, User-Configured, System-Processed, Other). Each information source is associated with a credibility preference to indicate precedence. In scenarios where a customized TE Topology is merged into a Client's native TE Topology, the merged topological elements would point to the corresponding customized TE Topology as its information source.



```

augment /nw:networks/nw:network/nw:node:
  +-rw te!
  .....
  +-ro information-source?          te-info-source
  +-ro information-source-instance? string
  +-ro information-source-state
  | +-ro credibility-preference?   uint16
  | +-ro logical-network-element?  string
  | +-ro network-instance?        string
  | +-ro topology
  |   +-ro node-ref?              leafref
  |   +-ro network-ref?          leafref
  +-ro information-source-entry*
  |   [information-source information-source-instance]
  |   +-ro information-source      te-info-source
  |   +-ro information-source-instance string
  .....

```

```

augment /nw:networks/nw:network/nt:link:
  +-rw te!
  .....
  +-ro information-source?          te-info-source
  +-ro information-source-instance? string
  +-ro information-source-state
  | +-ro credibility-preference?   uint16
  | +-ro logical-network-element?  string
  | +-ro network-instance?        string
  | +-ro topology
  |   +-ro link-ref?              leafref
  |   +-ro network-ref?          leafref
  +-ro information-source-entry*
  |   [information-source information-source-instance]
  |   +-ro information-source      te-info-source
  |   +-ro information-source-instance string
  .....

```

### 5.8. Overlay/Underlay Relationship

The model captures overlay and underlay relationship for TE nodes/links. For example - in networks where multiple TE Topologies are built hierarchically, this model allows the user to start from a specific topological element in the top most topology and traverse all the way down to the supporting topological elements in the bottom most topology.

This relationship is captured via the "underlay-topology" field for the node and via the "underlay" field for the link. The use of these





fields is optional and this functionality is tagged as a "feature" ("te-topology-hierarchy").

```

augment /nw:networks/nw:network/nw:node:
  +--rw te-node-id?   te-types:te-node-id
  +--rw te!
    +--rw te-node-template*          leafref {template}?
    +--rw te-node-attributes
      | +--rw admin-status?          te-types:te-admin-status
      | | .....
      | +--rw underlay-topology {te-topology-hierarchy}?
      |   +--rw network-ref? leafref
  
```

```

augment /nw:networks/nw:network/nt:link:
  +--rw te!
    +--rw te-link-attributes
      | .....
      | +--rw underlay {te-topology-hierarchy}?
      | | +--rw enabled?                boolean
      | | +--rw primary-path
      | | | +--rw network-ref? leafref
      | | | .....
      | | +--rw backup-path* [index]
      | | | +--rw index                uint32
      | | | +--rw network-ref? leafref
      | | | .....
      | | +--rw protection-type?        identityref
      | | +--rw tunnel-termination-points
      | | | +--rw source?                binary
      | | | +--rw destination?         binary
      | | +--rw tunnels
      | | | .....
  
```

### 5.9. Templates

The data model provides the users with the ability to define templates and apply them to link and node configurations. The use of "template" configuration is optional and this functionality is tagged as a "feature" ("template").

```

augment /nw:networks/nw:network/nw:node:
  +--rw te-node-id?   te-types:te-node-id
  +--rw te!
    +--rw te-node-template*
      | -> ../../../../te/templates/node-template/name
      | {template}?
  
```



```

augment /nw:networks/nw:network/nt:link:
  +--rw te!
    +--rw te-link-template*
      |      -> ../../../../te/templates/link-template/name
      |      {template}?

augment /nw:networks:
  +--rw te!
    +--rw templates
      +--rw node-template* [name] {template}?
        | +--rw name
        | |      te-types:te-template-name
        | +--rw priority?          uint16
        | +--rw reference-change-policy?  enumeration
        | +--rw te-node-attributes
        | .....
      +--rw link-template* [name] {template}?
        +--rw name
        |      te-types:te-template-name
        +--rw priority?          uint16
        +--rw reference-change-policy?  enumeration
        +--rw te-link-attributes
        .....

```

Multiple templates can be specified to a configuration element. When two or more templates specify values for the same configuration field, the value from the template with the highest priority is used. The range of the priority is from 0 to 65535, with a lower number indicating a higher priority. The reference-change-policy specifies the action that needs to be taken when the template changes on a configuration element that has a reference to this template. The choices of action include taking no action, rejecting the change to the template and applying the change to the corresponding configuration.

### 5.10. Scheduling Parameters

The model allows time scheduling parameters to be specified for each topological element or for the topology as a whole. These parameters allow the provider to present different topological views to the client at different time slots. The use of "scheduling parameters" is optional.

The YANG data model for configuration scheduling is defined in [\[I-D.liu-netmod-yang-schedule\]](#), which allows specifying configuration schedules without altering this data model.



### 5.11. Notifications

Notifications are a key component of any topology data model.

[I-D.ietf-netconf-subscribed-notifications] and [I-D.ietf-netconf-yang-push] define a subscription and push mechanism for YANG datastores. This mechanism currently allows the user to:

- Subscribe notifications on a per client basis
- Specify subtree filters or xpath filters so that only interested contents will be sent.
- Specify either periodic or on-demand notifications.

## 6. Guidance for Writing Technology Specific TE Topology Augmentations

The TE topology model defined in this document is technology agnostic as it defines concepts, abstractions and attributes that are common across multiple network technologies. It is envisioned that this base model will be widely used when defining technology specific TE topology models for various layer networks.

[I-D.ietf-ccamp-wson-yang], [I-D.ietf-ccamp-otn-topo-yang], and [I-D.ietf-teas-yang-l3-te-topo] are some examples of technology specific TE Topology models. Writers of such models are encouraged to augment the basic TE topology model's containers, such as TE Topology, TE Node, TE Link, Link Termination Point (LTP), Tunnel Termination Point (TTP), Bandwidth and Label with the layer specific attributes instead of defining new containers.

Consider the following technology specific example-topology model:

```

module: example-topology
  augment /nw:networks/nw:network/nw:network-types/tet:te-topology:
    +-rw example-topology!
  augment /nw:networks/nw:network/tet:te:
    +-rw attributes
      +-rw attribute-1?  uint8
  augment /nw:networks/nw:network/nw:node/tet:te
    /tet:te-node-attributes:
    +-rw attributes
      +-rw attribute-2?  uint8
  augment /nw:networks/nw:network/nw:node/tet:te
    /tet:te-node-attributes/tet:connectivity-matrices:
    +-rw attributes
      +-rw attribute-3?  uint8
  augment /nw:networks/nw:network/nw:node/tet:te

```

```

        /tet:te-node-attributes/tet:connectivity-matrices
        /tet:connectivity-matrix:
    +--rw attributes
      +--rw attribute-3?  uint8
augment /nw:networks/nw:network/nw:node/tet:te
  /tet:tunnel-termination-point:
    +--rw attributes
      +--rw attribute-4?  uint8
augment /nw:networks/nw:network/nw:node/nt:termination-point
  /tet:te:
    +--rw attributes
      +--rw attribute-5?  uint8
augment /nw:networks/nw:network/nt:link/tet:te
  /tet:te-link-attributes:
    +--rw attributes
      +--rw attribute-6?  uint8

```

The technology specific TE bandwidth for this example topology can be specified using the following augment statements:

```

augment /nw:networks/tet:te/tet:templates/tet:link-template
  /tet:te-link-attributes
  /tet:interface-switching-capability/tet:max-lsp-bandwidth
  /tet:te-bandwidth/tet:technology:
+--:(example)
  +--rw example
    +--rw bandwidth-1?  uint32
augment /nw:networks/tet:te/tet:templates/tet:link-template
  /tet:te-link-attributes/tet:max-link-bandwidth
  /tet:te-bandwidth/tet:technology:
+--:(example)
  +--rw example
    +--rw bandwidth-1?  uint32
augment /nw:networks/tet:te/tet:templates/tet:link-template
  /tet:te-link-attributes/tet:max-resv-link-bandwidth
  /tet:te-bandwidth/tet:technology:
+--:(example)
  +--rw example
    +--rw bandwidth-1?  uint32
augment /nw:networks/tet:te/tet:templates/tet:link-template

```

```

        /tet:te-link-attributes/tet:unreserved-bandwidth
        /tet:te-bandwidth/tet:technology:
+--:(example)
  +--rw example
    +--rw bandwidth-1?  uint32
augment /nw:networks/nw:network/nw:node/tet:te
  /tet:te-node-attributes/tet:connectivity-matrices
  /tet:path-constraints/tet:te-bandwidth/tet:technology:
+--:(example)
  +--rw example
    +--rw bandwidth-1?  uint32
augment /nw:networks/nw:network/nw:node/tet:te
  /tet:te-node-attributes/tet:connectivity-matrices
  /tet:connectivity-matrix/tet:path-constraints
  /tet:te-bandwidth/tet:technology:
+--:(example)
  +--rw example
    +--rw bandwidth-1?  uint32
augment /nw:networks/nw:network/nw:node/tet:te
  /tet:information-source-entry/tet:connectivity-matrices
  /tet:path-constraints/tet:te-bandwidth/tet:technology:
+--:(example)
  +--ro example
    +--ro bandwidth-1?  uint32
augment /nw:networks/nw:network/nw:node/tet:te
  /tet:information-source-entry/tet:connectivity-matrices
  /tet:connectivity-matrix/tet:path-constraints
  /tet:te-bandwidth/tet:technology:
+--:(example)
  +--ro example
    +--ro bandwidth-1?  uint32
augment /nw:networks/nw:network/nw:node/tet:te
  /tet:tunnel-termination-point/tet:client-layer-adaptation
  /tet:switching-capability/tet:te-bandwidth
  /tet:technology:
+--:(example)
  +--rw example
    +--rw bandwidth-1?  uint32
augment /nw:networks/nw:network/nw:node/tet:te
  /tet:tunnel-termination-point
  /tet:local-link-connectivities/tet:path-constraints

```

```

        /tet:te-bandwidth/tet:technology:
+--:(example)
  +-rw example
    +-rw bandwidth-1?  uint32
augment /nw:networks/nw:network/nw:node/tet:te
  /tet:tunnel-termination-point
  /tet:local-link-connectivities
  /tet:local-link-connectivity/tet:path-constraints
  /tet:te-bandwidth/tet:technology:
+--:(example)
  +-rw example
    +-rw bandwidth-1?  uint32
augment /nw:networks/nw:network/nt:link/tet:te
  /tet:te-link-attributes
  /tet:interface-switching-capability/tet:max-lsp-bandwidth
  /tet:te-bandwidth/tet:technology:
+--:(example)
  +-rw example
    +-rw bandwidth-1?  uint32
augment /nw:networks/nw:network/nt:link/tet:te
  /tet:te-link-attributes/tet:max-link-bandwidth
  /tet:te-bandwidth/tet:technology:
+--:(example)
  +-rw example
    +-rw bandwidth-1?  uint32
augment /nw:networks/nw:network/nt:link/tet:te
  /tet:te-link-attributes/tet:max-resv-link-bandwidth
  /tet:te-bandwidth/tet:technology:
+--:(example)
  +-rw example
    +-rw bandwidth-1?  uint32
augment /nw:networks/nw:network/nt:link/tet:te
  /tet:information-source-entry
  /tet:interface-switching-capability/tet:max-lsp-bandwidth
  /tet:te-bandwidth/tet:technology:
+--:(example)
  +-ro example
    +-ro bandwidth-1?  uint32
augment /nw:networks/nw:network/nt:link/tet:te
  /tet:information-source-entry/tet:max-link-bandwidth
  /tet:te-bandwidth/tet:technology:

```



```

+--:(example)
  +--ro example
    +--ro bandwidth-1?  uint32
augment /nw:networks/nw:network/nt:link/tet:te
  /tet:information-source-entry/tet:max-resv-link-bandwidth
  /tet:te-bandwidth/tet:technology:
+--:(example)
  +--ro example
    +--ro bandwidth-1?  uint32
augment /nw:networks/nw:network/nt:link/tet:te
  /tet:information-source-entry/tet:unreserved-bandwidth
  /tet:te-bandwidth/tet:technology:
+--:(example)
  +--ro example
    +--ro bandwidth-1?  uint32
augment /nw:networks/nw:network/nw:node/nt:termination-point/tet:te
  /tet:interface-switching-capability/tet:max-lsp-bandwidth
  /tet:te-bandwidth/tet:technology:
+--:(example)
  +--rw example
    +--rw bandwidth-1?  uint32

```

The technology specific TE label for this example topology can be specified using the following augment statements:

```

augment /nw:networks/tet:te/tet:templates/tet:link-template
  /tet:te-link-attributes/tet:underlay/tet:primary-path
  /tet:path-element/tet:type/tet:label/tet:label-hop
  /tet:te-label/tet:technology:
+--:(example)
  +--rw example
    +--rw label-1?  uint32
augment /nw:networks/tet:te/tet:templates/tet:link-template
  /tet:te-link-attributes/tet:underlay/tet:backup-path
  /tet:path-element/tet:type/tet:label/tet:label-hop
  /tet:te-label/tet:technology:
+--:(example)
  +--rw example
    +--rw label-1?  uint32
augment /nw:networks/tet:te/tet:templates/tet:link-template

```

```

        /tet:te-link-attributes/tet:label-restrictions
        /tet:label-restriction/tet:label-start/tet:te-label
        /tet:technology:
+--:(example)
  +--rw example
    +--rw label-1?  uint32
augment /nw:networks/tet:te/tet:templates/tet:link-template
  /tet:te-link-attributes/tet:label-restrictions
  /tet:label-restriction/tet:label-end/tet:te-label
  /tet:technology:
+--:(example)
  +--rw example
    +--rw label-1?  uint32
augment /nw:networks/nw:network/nw:node/tet:te
  /tet:te-node-attributes/tet:connectivity-matrices
  /tet:label-restrictions/tet:label-restriction
  /tet:label-start/tet:te-label/tet:technology:
+--:(example)
  +--rw example
    +--rw label-1?  uint32
augment /nw:networks/nw:network/nw:node/tet:te
  /tet:te-node-attributes/tet:connectivity-matrices
  /tet:label-restrictions/tet:label-restriction
  /tet:label-end/tet:te-label/tet:technology:
+--:(example)
  +--rw example
    +--rw label-1?  uint32
augment /nw:networks/nw:network/nw:node/tet:te
  /tet:te-node-attributes/tet:connectivity-matrices
  /tet:underlay/tet:primary-path/tet:path-element/tet:type
  /tet:label/tet:label-hop/tet:te-label/tet:technology:
+--:(example)
  +--rw example
    +--rw label-1?  uint32
augment /nw:networks/nw:network/nw:node/tet:te
  /tet:te-node-attributes/tet:connectivity-matrices
  /tet:underlay/tet:backup-path/tet:path-element/tet:type
  /tet:label/tet:label-hop/tet:te-label/tet:technology:
+--:(example)
  +--rw example
    +--rw label-1?  uint32

```

```

augment /nw:networks/nw:network/nw:node/tet:te
  /tet:te-node-attributes/tet:connectivity-matrices
  /tet:path-properties/tet:path-route-objects
  /tet:path-route-object/tet:type/tet:label/tet:label-hop
  /tet:te-label/tet:technology:
+--:(example)
  +--ro example
    +--ro label-1?  uint32
augment /nw:networks/nw:network/nw:node/tet:te
  /tet:te-node-attributes/tet:connectivity-matrices
  /tet:connectivity-matrix/tet:from/tet:label-restrictions
  /tet:label-restriction/tet:label-start/tet:te-label
  /tet:technology:
+--:(example)
  +--rw example
    +--rw label-1?  uint32
augment /nw:networks/nw:network/nw:node/tet:te
  /tet:te-node-attributes/tet:connectivity-matrices
  /tet:connectivity-matrix/tet:from/tet:label-restrictions
  /tet:label-restriction/tet:label-end/tet:te-label
  /tet:technology:
+--:(example)
  +--rw example
    +--rw label-1?  uint32
augment /nw:networks/nw:network/nw:node/tet:te
  /tet:te-node-attributes/tet:connectivity-matrices
  /tet:connectivity-matrix/tet:to/tet:label-restrictions
  /tet:label-restriction/tet:label-start/tet:te-label
  /tet:technology:
+--:(example)
  +--rw example
    +--rw label-1?  uint32
augment /nw:networks/nw:network/nw:node/tet:te
  /tet:te-node-attributes/tet:connectivity-matrices
  /tet:connectivity-matrix/tet:to/tet:label-restrictions
  /tet:label-restriction/tet:label-end/tet:te-label
  /tet:technology:
+--:(example)
  +--rw example
    +--rw label-1?  uint32
augment /nw:networks/nw:network/nw:node/tet:te

```

```

        /tet:te-node-attributes/tet:connectivity-matrices
        /tet:connectivity-matrix/tet:underlay/tet:primary-path
        /tet:path-element/tet:type/tet:label/tet:label-hop
        /tet:te-label/tet:technology:
+--:(example)
  +--rw example
    +--rw label-1?  uint32
augment /nw:networks/nw:network/nw:node/tet:te
  /tet:te-node-attributes/tet:connectivity-matrices
  /tet:connectivity-matrix/tet:underlay/tet:backup-path
  /tet:path-element/tet:type/tet:label/tet:label-hop
  /tet:te-label/tet:technology:
+--:(example)
  +--rw example
    +--rw label-1?  uint32
augment /nw:networks/nw:network/nw:node/tet:te
  /tet:te-node-attributes/tet:connectivity-matrices
  /tet:connectivity-matrix/tet:path-properties
  /tet:path-route-objects/tet:path-route-object/tet:type
  /tet:label/tet:label-hop/tet:te-label/tet:technology:
+--:(example)
  +--ro example
    +--ro label-1?  uint32
augment /nw:networks/nw:network/nw:node/tet:te
  /tet:information-source-entry/tet:connectivity-matrices
  /tet:label-restrictions/tet:label-restriction
  /tet:label-start/tet:te-label/tet:technology:
+--:(example)
  +--ro example
    +--ro label-1?  uint32
augment /nw:networks/nw:network/nw:node/tet:te
  /tet:information-source-entry/tet:connectivity-matrices
  /tet:label-restrictions/tet:label-restriction
  /tet:label-end/tet:te-label/tet:technology:
+--:(example)
  +--ro example
    +--ro label-1?  uint32
augment /nw:networks/nw:network/nw:node/tet:te
  /tet:information-source-entry/tet:connectivity-matrices
  /tet:underlay/tet:primary-path/tet:path-element/tet:type
  /tet:label/tet:label-hop/tet:te-label/tet:technology:

```

```

+--:(example)
  +--ro example
    +--ro label-1?  uint32
augment /nw:networks/nw:network/nw:node/tet:te
  /tet:information-source-entry/tet:connectivity-matrices
  /tet:underlay/tet:backup-path/tet:path-element/tet:type
  /tet:label/tet:label-hop/tet:te-label/tet:technology:
+--:(example)
  +--ro example
    +--ro label-1?  uint32
augment /nw:networks/nw:network/nw:node/tet:te
  /tet:information-source-entry/tet:connectivity-matrices
  /tet:path-properties/tet:path-route-objects
  /tet:path-route-object/tet:type/tet:label/tet:label-hop
  /tet:te-label/tet:technology:
+--:(example)
  +--ro example
    +--ro label-1?  uint32
augment /nw:networks/nw:network/nw:node/tet:te
  /tet:information-source-entry/tet:connectivity-matrices
  /tet:connectivity-matrix/tet:from/tet:label-restrictions
  /tet:label-restriction/tet:label-start/tet:te-label
  /tet:technology:
+--:(example)
  +--ro example
    +--ro label-1?  uint32
augment /nw:networks/nw:network/nw:node/tet:te
  /tet:information-source-entry/tet:connectivity-matrices
  /tet:connectivity-matrix/tet:from/tet:label-restrictions
  /tet:label-restriction/tet:label-end/tet:te-label
  /tet:technology:
+--:(example)
  +--ro example
    +--ro label-1?  uint32
augment /nw:networks/nw:network/nw:node/tet:te
  /tet:information-source-entry/tet:connectivity-matrices
  /tet:connectivity-matrix/tet:to/tet:label-restrictions
  /tet:label-restriction/tet:label-start/tet:te-label
  /tet:technology:
+--:(example)
  +--ro example

```

```

    +--ro label-1?  uint32
augment /nw:networks/nw:network/nw:node/tet:te
    /tet:information-source-entry/tet:connectivity-matrices
    /tet:connectivity-matrix/tet:to/tet:label-restrictions
    /tet:label-restriction/tet:label-end/tet:te-label
    /tet:technology:
+--:(example)
  +--ro example
    +--ro label-1?  uint32
augment /nw:networks/nw:network/nw:node/tet:te
    /tet:information-source-entry/tet:connectivity-matrices
    /tet:connectivity-matrix/tet:underlay/tet:primary-path
    /tet:path-element/tet:type/tet:label/tet:label-hop
    /tet:te-label/tet:technology:
+--:(example)
  +--ro example
    +--ro label-1?  uint32
augment /nw:networks/nw:network/nw:node/tet:te
    /tet:information-source-entry/tet:connectivity-matrices
    /tet:connectivity-matrix/tet:underlay/tet:backup-path
    /tet:path-element/tet:type/tet:label/tet:label-hop
    /tet:te-label/tet:technology:
+--:(example)
  +--ro example
    +--ro label-1?  uint32
augment /nw:networks/nw:network/nw:node/tet:te
    /tet:information-source-entry/tet:connectivity-matrices
    /tet:connectivity-matrix/tet:path-properties
    /tet:path-route-objects/tet:path-route-object/tet:type
    /tet:label/tet:label-hop/tet:te-label/tet:technology:
+--:(example)
  +--ro example
    +--ro label-1?  uint32
augment /nw:networks/nw:network/nw:node/tet:te
    /tet:tunnel-termination-point
    /tet:local-link-connectivities/tet:label-restrictions
    /tet:label-restriction/tet:label-start/tet:te-label
    /tet:technology:
+--:(example)
  +--rw example
    +--rw label-1?  uint32

```

```

augment /nw:networks/nw:network/nw:node/tet:te
  /tet:tunnel-termination-point
  /tet:local-link-connectivities/tet:label-restrictions
  /tet:label-restriction/tet:label-end/tet:te-label
  /tet:technology:
+--:(example)
  +--rw example
    +--rw label-1?  uint32
augment /nw:networks/nw:network/nw:node/tet:te
  /tet:tunnel-termination-point
  /tet:local-link-connectivities/tet:underlay
  /tet:primary-path/tet:path-element/tet:type/tet:label
  /tet:label-hop/tet:te-label/tet:technology:
+--:(example)
  +--rw example
    +--rw label-1?  uint32
augment /nw:networks/nw:network/nw:node/tet:te
  /tet:tunnel-termination-point
  /tet:local-link-connectivities/tet:underlay
  /tet:backup-path/tet:path-element/tet:type/tet:label
  /tet:label-hop/tet:te-label/tet:technology:
+--:(example)
  +--rw example
    +--rw label-1?  uint32
augment /nw:networks/nw:network/nw:node/tet:te
  /tet:tunnel-termination-point
  /tet:local-link-connectivities/tet:path-properties
  /tet:path-route-objects/tet:path-route-object/tet:type
  /tet:label/tet:label-hop/tet:te-label/tet:technology:
+--:(example)
  +--ro example
    +--ro label-1?  uint32
augment /nw:networks/nw:network/nw:node/tet:te
  /tet:tunnel-termination-point
  /tet:local-link-connectivities
  /tet:local-link-connectivity/tet:label-restrictions
  /tet:label-restriction/tet:label-start/tet:te-label
  /tet:technology:
+--:(example)
  +--rw example
    +--rw label-1?  uint32

```

```

augment /nw:networks/nw:network/nw:node/tet:te
  /tet:tunnel-termination-point
  /tet:local-link-connectivities
  /tet:local-link-connectivity/tet:label-restrictions
  /tet:label-restriction/tet:label-end/tet:te-label
  /tet:technology:
+--:(example)
  +--rw example
    +--rw label-1?  uint32
augment /nw:networks/nw:network/nw:node/tet:te
  /tet:tunnel-termination-point
  /tet:local-link-connectivities
  /tet:local-link-connectivity/tet:underlay
  /tet:primary-path/tet:path-element/tet:type/tet:label
  /tet:label-hop/tet:te-label/tet:technology:
+--:(example)
  +--rw example
    +--rw label-1?  uint32
augment /nw:networks/nw:network/nw:node/tet:te
  /tet:tunnel-termination-point
  /tet:local-link-connectivities
  /tet:local-link-connectivity/tet:underlay/tet:backup-path
  /tet:path-element/tet:type/tet:label/tet:label-hop
  /tet:te-label/tet:technology:
+--:(example)
  +--rw example
    +--rw label-1?  uint32
augment /nw:networks/nw:network/nw:node/tet:te
  /tet:tunnel-termination-point
  /tet:local-link-connectivities
  /tet:local-link-connectivity/tet:path-properties
  /tet:path-route-objects/tet:path-route-object/tet:type
  /tet:label/tet:label-hop/tet:te-label/tet:technology:
+--:(example)
  +--ro example
    +--ro label-1?  uint32
augment /nw:networks/nw:network/nt:link/tet:te
  /tet:te-link-attributes/tet:label-restrictions
  /tet:label-restriction/tet:label-start/tet:te-label
  /tet:technology:
+--:(example)

```



```

    +--rw example
      +--rw label-1?  uint32
augment /nw:networks/nw:network/nt:link/tet:te
  /tet:te-link-attributes/tet:label-restrictions
  /tet:label-restriction/tet:label-end/tet:te-label
  /tet:technology:
+--:(example)
  +--rw example
    +--rw label-1?  uint32
augment /nw:networks/nw:network/nt:link/tet:te
  /tet:te-link-attributes/tet:underlay/tet:primary-path
  /tet:path-element/tet:type/tet:label/tet:label-hop
  /tet:te-label/tet:technology:
+--:(example)
  +--rw example
    +--rw label-1?  uint32
augment /nw:networks/nw:network/nt:link/tet:te
  /tet:te-link-attributes/tet:underlay/tet:backup-path
  /tet:path-element/tet:type/tet:label/tet:label-hop
  /tet:te-label/tet:technology:
+--:(example)
  +--rw example
    +--rw label-1?  uint32
augment /nw:networks/nw:network/nt:link/tet:te
  /tet:information-source-entry/tet:label-restrictions
  /tet:label-restriction/tet:label-start/tet:te-label
  /tet:technology:
+--:(example)
  +--ro example
    +--ro label-1?  uint32
augment /nw:networks/nw:network/nt:link/tet:te
  /tet:information-source-entry/tet:label-restrictions
  /tet:label-restriction/tet:label-end/tet:te-label
  /tet:technology:
+--:(example)
  +--ro example
    +--ro label-1?  uint32

```

The YANG module to implement the above example topology can be seen in [Appendix C](#).

## 7. TE Topology YANG Module

This module references [\[RFC1195\]](#), [\[RFC3209\]](#), [\[RFC3272\]](#), [\[RFC3471\]](#), [\[RFC3630\]](#), [\[RFC3785\]](#), [\[RFC4201\]](#), [\[RFC4202\]](#), [\[RFC4203\]](#), [\[RFC4206\]](#), [\[RFC4872\]](#), [\[RFC5152\]](#), [\[RFC5212\]](#), [\[RFC5305\]](#), [\[RFC5316\]](#), [\[RFC5329\]](#), [\[RFC5392\]](#), [\[RFC6001\]](#), [\[RFC6241\]](#), [\[RFC6991\]](#), [\[RFC7308\]](#), [\[RFC7471\]](#), [\[RFC7579\]](#), [\[RFC7752\]](#), [\[RFC8345\]](#), and [\[I-D.ietf-teas-yang-te-types\]](#).

```
<CODE BEGINS> file "ietf-te-topology@2019-02-07.yang"
module ietf-te-topology {
  yang-version 1.1;
  namespace "urn:ietf:params:xml:ns:yang:ietf-te-topology";

  prefix "tet";

  import ietf-yang-types {
    prefix "yang";
    reference "RFC 6991: Common YANG Data Types";
  }

  import ietf-inet-types {
    prefix "inet";
    reference "RFC 6991: Common YANG Data Types";
  }

  import ietf-te-types {
    prefix "te-types";
    reference
      "I-D.ietf-teas-yang-te-types: Traffic Engineering Common YANG
      Types";
  }

  import ietf-network {
    prefix "nw";
    reference "RFC 8345: A YANG Data Model for Network Topologies";
  }

  import ietf-network-topology {
    prefix "nt";
    reference "RFC 8345: A YANG Data Model for Network Topologies";
  }
}
```

## organization

"IETF Traffic Engineering Architecture and Signaling (TEAS)  
Working Group";

## contact

"WG Web: <<http://tools.ietf.org/wg/teas/>>

WG List: <<mailto:teas@ietf.org>>

Editor: Xufeng Liu  
<<mailto:xufeng.liu.ietf@gmail.com>>

Editor: Igor Bryskin  
<<mailto:Igor.Bryskin@huawei.com>>

Editor: Vishnu Pavan Beeram  
<<mailto:vbeeram@juniper.net>>

Editor: Tarek Saad  
<<mailto:tsaad@juniper.net>>

Editor: Himanshu Shah  
<<mailto:hshah@ciena.com>>

Editor: Oscar Gonzalez De Dios  
<<mailto:oscar.gonzalezdedios@telefonica.com>>"

## description

"TE topology model for representing and manipulating technology  
agnostic TE Topologies.

Copyright (c) 2019 IETF Trust and the persons identified as  
authors of the code. All rights reserved.

Redistribution and use in source and binary forms, with or  
without modification, is permitted pursuant to, and subject to  
the license terms contained in, the Simplified BSD License set  
forth in [Section 4.c](#) of the IETF Trust's Legal Provisions  
Relating to IETF Documents  
(<http://trustee.ietf.org/license-info>).

This version of this YANG module is part of RFC XXXX; see the

```
    RFC itself for full legal notices.";

revision "2019-02-07" {
    description "Initial revision";
    reference "RFC XXXX: YANG Data Model for TE Topologies";
    // RFC Ed.: replace XXXX with actual RFC number and remove
    // this note
}

/*
 * Features
 */
feature nsrlg {
    description
        "This feature indicates that the system supports NSRLG
        (Not Sharing Risk Link Group).";
}

feature te-topology-hierarchy {
    description
        "This feature indicates that the system allows underlay
        and/or overlay TE topology hierarchy.";
}

feature template {
    description
        "This feature indicates that the system supports
        template configuration.";
}

/*
 * Typedefs
 */
typedef geographic-coordinate-degree {
    type decimal64 {
        fraction-digits 8;
    }
    description
        "Decimal degree (DD) used to express latitude and longitude
        geographic coordinates.";
} // geographic-coordinate-degree
```

```
typedef te-info-source {
  type enumeration {
    enum "unknown" {
      description "The source is unknown.";
    }
    enum "locally-configured" {
      description "Configured entity.";
    }
    enum "ospfv2" {
      description "OSPFv2.";
    }
    enum "ospfv3" {
      description "OSPFv3.";
    }
    enum "isis" {
      description "ISIS.";
    }
    enum "bgp-ls" {
      description "BGP-LS.";
      reference
        "RFC 7752: North-Bound Distribution of Link-State and
        Traffic Engineering (TE) Information Using BGP";
    }
    enum "system-processed" {
      description "System processed entity.";
    }
    enum "other" {
      description "Other source.";
    }
  }
  description
    "Describing the type of source that has provided the
    related information, and the source credibility.";
} // te-info-source

/*
 * Groupings
 */
grouping connectivity-matrix-entry-path-attributes {
  description
```

```
    "Attributes of connectivity matrix entry.";
  leaf is-allowed {
    type boolean;
    description
      "true - switching is allowed,
       false - switching is disallowed.";
  }
  container underlay {
    if-feature te-topology-hierarchy;
    description "Attributes of the te-link underlay.";
    reference
      "RFC 4206: Label Switched Paths (LSP) Hierarchy with
       Generalized Multi-Protocol Label Switching (GMPLS)
       Traffic Engineering (TE)";

    uses te-link-underlay-attributes;
  } // underlay

  uses te-types:generic-path-constraints;
  uses te-types:generic-path-optimization;
  uses te-types:generic-path-properties;
} // connectivity-matrix-entry-path-attributes

grouping geolocation-container {
  description
    "A container containing a GPS location.";
  container geolocation{
    config false;
    description
      "A container containing a GPS location.";
    leaf altitude {
      type int64;
      units millimeter;
      description
        "Distance above the sea level.";
    }
    leaf latitude {
      type geographic-coordinate-degree {
        range "-90..90";
      }
    }
    description

```

```
        "Relative position north or south on the Earth's surface.";
    }
    leaf longitude {
        type geographic-coordinate-degree {
            range "-180..180";
        }
        description
            "Angular distance east or west on the Earth's surface.";
    }
} // gps-location
} // geolocation-container

grouping information-source-state-attributes {
    description
        "The attributes identifying source that has provided the
        related information, and the source credibility.";
    leaf credibility-preference {
        type uint16;
        description
            "The preference value to calculate the traffic
            engineering database credibility value used for
            tie-break selection between different
            information-source values.
            Higher value is more preferable.";
    }
    leaf logical-network-element {
        type string;
        description
            "When applicable, this is the name of a logical network
            element from which the information is learned.";
    } // logical-network-element
    leaf network-instance {
        type string;
        description
            "When applicable, this is the name of a network-instance
            from which the information is learned.";
    } // network-instance
} // information-source-state-attributes

grouping information-source-per-link-attributes {
    description
```

```
    "Per node container of the attributes identifying source that
      has provided the related information, and the source
      credibility.";
leaf information-source {
  type te-info-source;
  config false;
  description
    "Indicates the type of the information source.";
}
leaf information-source-instance {
  type string;
  config false;
  description
    "The name indicating the instance of the information
      source.";
}
container information-source-state {
  config false;
  description
    "The container contains state attributes related to
      the information source.";
  uses information-source-state-attributes;
  container topology {
    description
      "When the information is processed by the system,
        the attributes in this container indicate which topology
        is used to process to generate the result information.";
    uses nt:link-ref;
  } // topology
} // information-source-state
} // information-source-per-link-attributes

grouping information-source-per-node-attributes {
  description
    "Per node container of the attributes identifying source that
      has provided the related information, and the source
      credibility.";
  leaf information-source {
    type te-info-source;
    config false;
    description
```



```
        "Indicates the type of the information source.";
    }
    leaf information-source-instance {
        type string;
        config false;
        description
            "The name indicating the instance of the information
            source.";
    }
    container information-source-state {
        config false;
        description
            "The container contains state attributes related to
            the information source.";
        uses information-source-state-attributes;
        container topology {
            description
                "When the information is processed by the system,
                the attributes in this container indicate which topology
                is used to process to generate the result information.";
            uses nw:node-ref;
        } // topology
    } // information-source-state
} // information-source-per-node-attributes

grouping interface-switching-capability-list {
    description
        "List of Interface Switching Capabilities Descriptors (ISCD)";
    list interface-switching-capability {
        key "switching-capability encoding";
        description
            "List of Interface Switching Capabilities Descriptors (ISCD)
            for this link.";
        reference
            "RFC 3471: Generalized Multi-Protocol Label Switching (GMPLS)
            Signaling Functional Description.
            RFC 4203: OSPF Extensions in Support of Generalized
            Multi-Protocol Label Switching (GMPLS).";
    }
    leaf switching-capability {
        type identityref {
            base te-types:switching-capabilities;
        }
    }
}
```

```
    }
    description
      "Switching Capability for this interface.";
  }
  leaf encoding {
    type identityref {
      base te-types:lsp-encoding-types;
    }
    description
      "Encoding supported by this interface.";
  }
  uses te-link-iscd-attributes;
} // interface-switching-capability
} // interface-switching-capability-list

grouping statistics-per-link {
  description
    "Statistics attributes per TE link.";
  leaf discontinuity-time {
    type yang:date-and-time;
    description
      "The time on the most recent occasion at which any one or
      more of this interface's counters suffered a
      discontinuity.  If no such discontinuities have occurred
      since the last re-initialization of the local management
      subsystem, then this node contains the time the local
      management subsystem re-initialized itself.";
  }
  /* Administrative attributes */
  leaf disables {
    type yang:counter32;
    description
      "Number of times that link was disabled.";
  }
  leaf enables {
    type yang:counter32;
    description
      "Number of times that link was enabled.";
  }
  leaf maintenance-clears {
    type yang:counter32;
```

```
    description
      "Number of times that link was put out of maintenance.";
  }
  leaf maintenance-sets {
    type yang:counter32;
    description
      "Number of times that link was put in maintenance.";
  }
  leaf modifies {
    type yang:counter32;
    description
      "Number of times that link was modified.";
  }
  /* Operational attributes */
  leaf downs {
    type yang:counter32;
    description
      "Number of times that link was set to operational down.";
  }
  leaf ups {
    type yang:counter32;
    description
      "Number of times that link was set to operational up.";
  }
  /* Recovery attributes */
  leaf fault-clears {
    type yang:counter32;
    description
      "Number of times that link experienced fault clear event.";
  }
  leaf fault-detects {
    type yang:counter32;
    description
      "Number of times that link experienced fault detection.";
  }
  leaf protection-switches {
    type yang:counter32;
    description
      "Number of times that link experienced protection
        switchover.";
  }
}
```

```
leaf protection-reverts {
  type yang:counter32;
  description
    "Number of times that link experienced protection
    reversion.";
}
leaf restoration-failures {
  type yang:counter32;
  description
    "Number of times that link experienced restoration
    failure.";
}
leaf restoration-starts {
  type yang:counter32;
  description
    "Number of times that link experienced restoration
    start.";
}
leaf restoration-successes {
  type yang:counter32;
  description
    "Number of times that link experienced restoration
    success.";
}
leaf restoration-reversion-failures {
  type yang:counter32;
  description
    "Number of times that link experienced restoration reversion
    failure.";
}
leaf restoration-reversion-starts {
  type yang:counter32;
  description
    "Number of times that link experienced restoration reversion
    start.";
}
leaf restoration-reversion-successes {
  type yang:counter32;
  description
    "Number of times that link experienced restoration reversion
    success.";
```

```
    }  
  } // statistics-per-link  
  
  grouping statistics-per-node {  
    description  
      "Statistics attributes per TE node.";  
    leaf discontinuity-time {  
      type yang:date-and-time;  
      description  
        "The time on the most recent occasion at which any one or  
        more of this interface's counters suffered a  
        discontinuity. If no such discontinuities have occurred  
        since the last re-initialization of the local management  
        subsystem, then this node contains the time the local  
        management subsystem re-initialized itself.";  
    }  
    container node {  
      description  
        "Containing TE node level statistics attributes.";  
      leaf disables {  
        type yang:counter32;  
        description  
          "Number of times that node was disabled.";  
      }  
      leaf enables {  
        type yang:counter32;  
        description  
          "Number of times that node was enabled.";  
      }  
      leaf maintenance-sets {  
        type yang:counter32;  
        description  
          "Number of times that node was put in maintenance.";  
      }  
      leaf maintenance-clears {  
        type yang:counter32;  
        description  
          "Number of times that node was put out of maintenance.";  
      }  
      leaf modifies {  
        type yang:counter32;
```

```
        description
            "Number of times that node was modified.";
    }
} // node
container connectivity-matrix-entry {
    description
        "Containing connectivity matrix entry level statistics
        attributes.";
    leaf creates {
        type yang:counter32;
        description
            "Number of times that a connectivity matrix entry was
            created.";
        reference
            "RFC 6241. Section 7.2 for 'create' operation. ";
    }
    leaf deletes {
        type yang:counter32;
        description
            "Number of times that a connectivity matrix entry was
            deleted.";
        reference
            "RFC 6241. Section 7.2 for 'delete' operation. ";
    }
    leaf disables {
        type yang:counter32;
        description
            "Number of times that a connectivity matrix entry was
            disabled.";
    }
    leaf enables {
        type yang:counter32;
        description
            "Number of times that a connectivity matrix entry was
            enabled.";
    }
    leaf modifies {
        type yang:counter32;
        description
            "Number of times that a connectivity matrix entry was
            modified.";
```

```
    }
  } // connectivity-matrix-entry
} // statistics-per-node

grouping statistics-per-ttp {
  description
    "Statistics attributes per TE TTP (Tunnel Termination Point).";
  leaf discontinuity-time {
    type yang:date-and-time;
    description
      "The time on the most recent occasion at which any one or
      more of this interface's counters suffered a
      discontinuity. If no such discontinuities have occurred
      since the last re-initialization of the local management
      subsystem, then this node contains the time the local
      management subsystem re-initialized itself.";
  }
  container tunnel-termination-point {
    description
      "Containing TE TTP (Tunnel Termination Point) level
      statistics attributes.";
    /* Administrative attributes */
    leaf disables {
      type yang:counter32;
      description
        "Number of times that TTP was disabled.";
    }
    leaf enables {
      type yang:counter32;
      description
        "Number of times that TTP was enabled.";
    }
    leaf maintenance-clears {
      type yang:counter32;
      description
        "Number of times that TTP was put out of maintenance.";
    }
    leaf maintenance-sets {
      type yang:counter32;
      description
        "Number of times that TTP was put in maintenance.";
    }
  }
}
```

```
    }
    leaf modifies {
      type yang:counter32;
      description
        "Number of times that TTP was modified.";
    }
    /* Operational attributes */
    leaf downs {
      type yang:counter32;
      description
        "Number of times that TTP was set to operational down.";
    }
    leaf ups {
      type yang:counter32;
      description
        "Number of times that TTP was set to operational up.";
    }
    leaf in-service-clears {
      type yang:counter32;
      description
        "Number of times that TTP was taken out of service
        (TE tunnel was released).";
    }
    leaf in-service-sets {
      type yang:counter32;
      description
        "Number of times that TTP was put in service by a TE
        tunnel (TE tunnel was set up).";
    }
  } // tunnel-termination-point

container local-link-connectivity {
  description
    "Containing TE LLCL (Local Link Connectivity List) level
    statistics attributes.";
  leaf creates {
    type yang:counter32;
    description
      "Number of times that an LLCL entry was created.";
    reference
      "RFC 6241. Section 7.2 for 'create' operation.";
  }
}
```



```
    }
    leaf deletes {
      type yang:counter32;
      description
        "Number of times that an LLCL entry was deleted.";
      reference
        "RFC 6241. Section 7.2 for 'delete' operation.";
    }
    leaf disables {
      type yang:counter32;
      description
        "Number of times that an LLCL entry was disabled.";
    }
    leaf enables {
      type yang:counter32;
      description
        "Number of times that an LLCL entry was enabled.";
    }
    leaf modifies {
      type yang:counter32;
      description
        "Number of times that an LLCL entry was modified.";
    }
  } // local-link-connectivity
} // statistics-per-ttp

grouping te-link-augment {
  description
    "Augmentation for TE link.";
  uses te-link-config;
  uses te-link-state-derived;
  container statistics {
    config false;
    description
      "Statistics data.";
    uses statistics-per-link;
  } // statistics
} // te-link-augment

grouping te-link-config {
  description
```

```
"TE link configuration grouping.";
choice bundle-stack-level {
  description
    "The TE link can be partitioned into bundled
    links, or component links.";
  case bundle {
    container bundled-links {
      description
        "A set of bundled links.";
      reference
        "RFC 4201: Link Bundling in MPLS Traffic Engineering
        (TE).";
      list bundled-link {
        key "sequence";
        description
          "Specify a bundled interface that is
          further partitioned.";
        leaf sequence {
          type uint32;
          description
            "Identify the sequence in the bundle.";
        }
      } // list bundled-link
    }
  }
  case component {
    container component-links {
      description
        "A set of component links";
      list component-link {
        key "sequence";
        description
          "Specify a component interface that is
          sufficient to unambiguously identify the
          appropriate resources";

        leaf sequence {
          type uint32;
          description
            "Identify the sequence in the bundle.";
        }
      }
    }
  }
}
```

```

        leaf src-interface-ref {
            type string;
            description
                "Reference to component link interface on the
                 source node.";
        }
        leaf des-interface-ref {
            type string;
            description
                "Reference to component link interface on the
                 destinatioin node.";
        }
    }
}
} // bundle-stack-level

leaf-list te-link-template {
    if-feature template;
    type leafref {
        path "../../../../../te/templates/link-template/name";
    }
    description
        "The reference to a TE link template.";
}
uses te-link-config-attributes;
} // te-link-config

grouping te-link-config-attributes {
    description
        "Link configuration attributes in a TE topology.";
    container te-link-attributes {
        description "Link attributes in a TE topology.";
        leaf access-type {
            type te-types:te-link-access-type;
            description
                "Link access type, which can be point-to-point or
                 multi-access.";
        }
        container external-domain {
            description

```

```
    "For an inter-domain link, specify the attributes of
    the remote end of link, to facilitate the signalling at
    local end.";
  uses nw:network-ref;
  leaf remote-te-node-id {
    type te-types:te-node-id;
    description
      "Remote TE node identifier, used together with
      remote-te-link-id to identify the remote link
      termination point in a different domain.";
  }
  leaf remote-te-link-tp-id {
    type te-types:te-tp-id;
    description
      "Remote TE link termination point identifier, used
      together with remote-te-node-id to identify the remote
      link termination point in a different domain.";
  }
}
leaf is-abstract {
  type empty;
  description "Present if the link is abstract.";
}
leaf name {
  type string;
  description "Link Name.";
}
container underlay {
  if-feature te-topology-hierarchy;
  description "Attributes of the te-link underlay.";
  reference
    "RFC 4206: Label Switched Paths (LSP) Hierarchy with
    Generalized Multi-Protocol Label Switching (GMPLS)
    Traffic Engineering (TE)";

  uses te-link-underlay-attributes;
} // underlay
leaf admin-status {
  type te-types:te-admin-status;
  description
    "The administrative state of the link.";
```

```
    }

    uses te-link-info-attributes;
  } // te-link-attributes
} // te-link-config-attributes

grouping te-link-info-attributes {
  description
    "Advertised TE information attributes.";
  leaf link-index {
    type uint64;
    description
      "The link identifier.  If OSPF is used, this represents an
      ospfLsdbID.  If IS-IS is used, this represents an isisLSPID.
      If a locally configured link is used, this object represents
      a unique value, which is locally defined in a router.";
  }
  leaf administrative-group {
    type te-types:admin-groups;
    description
      "Administrative group or color of the link.
      This attribute covers both administrative group (defined in
      RFC 3630, RFC 5305 and RFC 5329), and extended
      administrative group (defined in RFC 7308).";
  }
}

uses interface-switching-capability-list;
uses te-types:label-set-info;

leaf link-protection-type {
  type identityref {
    base te-types:link-protection-type;
  }
  description
    "Link Protection Type desired for this link.";
  reference
    "RFC 4202: Routing Extensions in Support of
    Generalized Multi-Protocol Label Switching (GMPLS).";
}

container max-link-bandwidth {
```

```
    uses te-types:te-bandwidth;
    description
      "Maximum bandwidth that can be seen on this link in this
        direction. Units in bytes per second.";
    reference
      "RFC 3630: Traffic Engineering (TE) Extensions to OSPF
        Version 2.
      RFC 5305: IS-IS Extensions for Traffic Engineering.";
  }
  container max-resv-link-bandwidth {
    uses te-types:te-bandwidth;
    description
      "Maximum amount of bandwidth that can be reserved in this
        direction in this link. Units in bytes per second.";
    reference
      "RFC 3630: Traffic Engineering (TE) Extensions to OSPF
        Version 2.
      RFC 5305: IS-IS Extensions for Traffic Engineering.";
  }
  list unreserved-bandwidth {
    key "priority";
    max-elements "8";
    description
      "Unreserved bandwidth for 0-7 priority levels. Units in
        bytes per second.";
    reference
      "RFC 3630: Traffic Engineering (TE) Extensions to OSPF
        Version 2.
      RFC 5305: IS-IS Extensions for Traffic Engineering.";
    leaf priority {
      type uint8 {
        range "0..7";
      }
      description "Priority.";
    }
    uses te-types:te-bandwidth;
  }
  leaf te-default-metric {
    type uint32;
    description
      "Traffic engineering metric.";
```

```
reference
  "RFC 3630: Traffic Engineering (TE) Extensions to OSPF
  Version 2.
  RFC 5305: IS-IS Extensions for Traffic Engineering.";
}
leaf te-delay-metric {
  type uint32;
  description
    "Traffic engineering delay metric.";
  reference
    "RFC 7471: OSPF Traffic Engineering (TE) Metric Extensions.";
}
leaf te-igp-metric {
  type uint32;
  description
    "IGP metric used for traffic engineering.";
  reference
    "RFC 3785: Use of Interior Gateway Protocol (IGP) Metric as a
    Second MPLS Traffic Engineering (TE) Metric.";
}
container te-srlgs {
  description
    "Containing a list of SRLGs.";
  leaf-list value {
    type te-types:srlg;
    description "SRLG value.";
    reference
      "RFC 4202: Routing Extensions in Support of
      Generalized Multi-Protocol Label Switching (GMPLS).";
  }
}
container te-nsrlgs {
  if-feature nsrlg;
  description
    "Containing a list of NSRLGs (Not Sharing Risk Link
    Groups).
    When an abstract TE link is configured, this list specifies
    the request that underlay TE paths need to be mutually
    disjoint with other TE links in the same groups.";
  leaf-list id {
    type uint32;
```

```
        description
          "NSRLG ID, uniquely configured within a topology.";
        reference
          "RFC 4872: RSVP-TE Extensions in Support of End-to-End
          Generalized Multi-Protocol Label Switching (GMPLS)
          Recovery";
      }
    }
  } // te-link-info-attributes

grouping te-link-iscd-attributes {
  description
    "TE link ISCD (Interface Switching Capability Descriptor)
    attributes.";
  reference
    "Sec 1.4, RFC 4203: OSPF Extensions in Support of Generalized
    Multi-Protocol Label Switching (GMPLS). Section 1.4.";
  list max-lsp-bandwidth {
    key "priority";
    max-elements "8";
    description
      "Maximum LSP Bandwidth at priorities 0-7.";
    leaf priority {
      type uint8 {
        range "0..7";
      }
      description "Priority.";
    }
    uses te-types:te-bandwidth;
  }
} // te-link-iscd-attributes

grouping te-link-state-derived {
  description
    "Link state attributes in a TE topology.";
  leaf oper-status {
    type te-types:te-oper-status;
    config false;
    description
      "The current operational state of the link.";
  }
}
```



```
leaf is-transitional {
  type empty;
  config false;
  description
    "Present if the link is transitional, used as an
     alternative approach in lieu of inter-layer-lock-id
     for path computation in a TE topology covering multiple
     layers or multiple regions.";
  reference
    "RFC 5212: Requirements for GMPLS-Based Multi-Region and
     Multi-Layer Networks (MRN/MLN).
     RFC 6001: Generalized MPLS (GMPLS) Protocol Extensions
     for Multi-Layer and Multi-Region Networks (MLN/MRN).";
}
uses information-source-per-link-attributes;
list information-source-entry {
  key "information-source information-source-instance";
  config false;
  description
    "A list of information sources learned, including the one
     used.";
  uses information-source-per-link-attributes;
  uses te-link-info-attributes;
}
container recovery {
  config false;
  description
    "Status of the recovery process.";
  leaf restoration-status {
    type te-types:te-recovery-status;
    description
      "Restoration status.";
  }
  leaf protection-status {
    type te-types:te-recovery-status;
    description
      "Protection status.";
  }
}
}
container underlay {
  if-feature te-topology-hierarchy;
```

```
    config false;
    description "State attributes for te-link underlay.";
    leaf dynamic {
        type boolean;
        description
            "true if the underlay is dynamically created.";
    }
    leaf committed {
        type boolean;
        description
            "true if the underlay is committed.";
    }
}
} // te-link-state-derived

grouping te-link-underlay-attributes {
    description "Attributes for te-link underlay.";
    reference
        "RFC 4206: Label Switched Paths (LSP) Hierarchy with
        Generalized Multi-Protocol Label Switching (GMPLS)
        Traffic Engineering (TE)";
    leaf enabled {
        type boolean;
        description
            "'true' if the underlay is enabled.
            'false' if the underlay is disabled.";
    }
}
container primary-path {
    description
        "The service path on the underlay topology that
        supports this link.";
    uses nw:network-ref;
    list path-element {
        key "path-element-id";
        description
            "A list of path elements describing the service path.";
        leaf path-element-id {
            type uint32;
            description "To identify the element in a path.";
        }
    }
    uses te-path-element;
```

```
    }  
  } // primary-path  
  list backup-path {  
    key "index";  
    description  
      "A list of backup service paths on the underlay topology that  
      protect the underlay primary path. If the primary path is  
      not protected, the list contains zero elements. If the  
      primary path is protected, the list contains one or more  
      elements.";  
    leaf index {  
      type uint32;  
      description  
        "A sequence number to identify a backup path.";  
    }  
    uses nw:network-ref;  
    list path-element {  
      key "path-element-id";  
      description  
        "A list of path elements describing the backup service  
        path";  
      leaf path-element-id {  
        type uint32;  
        description "To identify the element in a path.";  
      }  
      uses te-path-element;  
    }  
  } // underlay-backup-path  
  leaf protection-type {  
    type identityref {  
      base te-types:lsp-protection-type;  
    }  
    description  
      "Underlay protection type desired for this link.";  
  }  
  container tunnel-termination-points {  
    description  
      "Underlay TTP(Tunnel Termination Points) desired for this  
      link.";  
    leaf source {  
      type binary;  
    }  
  }  
}
```

```
    description
      "Source tunnel termination point identifier.";
  }
  leaf destination {
    type binary;
    description
      "Destination tunnel termination point identifier.";
  }
}
container tunnels {
  description
    "Underlay TE tunnels supporting this TE link.";
  leaf sharing {
    type boolean;
    default true;
    description
      "'true' if the underlay tunnel can be shared with other
      TE links;
      'false' if the underlay tunnel is dedicated to this
      TE link.
      This leaf is the default option for all TE tunnels,
      and may be overridden by the per TE tunnel value.";
  }
  list tunnel {
    key "tunnel-name";
    description
      "Zero, one or more underlay TE tunnels that support this TE
      link.";
    leaf tunnel-name {
      type string;
      description
        "A tunnel name uniquely identifies an underlay TE tunnel,
        used together with the source-node of this link.
        The detailed information of this tunnel can be retrieved
        from the ietf-te model.";
      reference "RFC 3209";
    }
  }
  leaf sharing {
    type boolean;
    description
      "'true' if the underlay tunnel can be shared with other
```

```
        TE links;
        'false' if the underlay tunnel is dedicated to this
        TE link.";
    }
} // tunnel
} // tunnels
} // te-link-underlay-attributes

grouping te-node-augment {
  description
    "Augmentation for TE node.";
  uses te-node-config;
  uses te-node-state-derived;
  container statistics {
    config false;
    description
      "Statistics data.";
    uses statistics-per-node;
  } // statistics

  list tunnel-termination-point {
    key "tunnel-tp-id";
    description
      "A termination point can terminate a tunnel.";
    leaf tunnel-tp-id {
      type binary;
      description
        "Tunnel termination point identifier.";
    }

    uses te-node-tunnel-termination-point-config;
    leaf oper-status {
      type te-types:te-oper-status;
      config false;
      description
        "The current operational state of the tunnel
        termination point.";
    }
  }
  uses geolocation-container;
  container statistics {
    config false;
  }
}
```

```
    description
      "Statistics data.";
    uses statistics-per-ttp;
  } // statistics

  // Relations to other tunnel termination points
  list supporting-tunnel-termination-point {
    key "node-ref tunnel-tp-ref";
    description
      "Identifies the tunnel termination points, that this
       tunnel termination point is depending on.";
    leaf node-ref {
      type inet:uri;
      description
        "This leaf identifies the node in which the supporting
         tunnel termination point is present.
         This node is either the supporting node or a node in
         an underlay topology.";
    }
    leaf tunnel-tp-ref {
      type binary;
      description
        "Reference to a tunnel termination point, which is
         either in the supporting node or a node in an
         underlay topology.";
    }
  } // supporting-tunnel-termination-point
} // tunnel-termination-point
} // te-node-augment

grouping te-node-config {
  description "TE node configuration grouping.";
  leaf-list te-node-template {
    if-feature template;
    type leafref {
      path "../../../../../te/templates/node-template/name";
    }
  }
  description
    "The reference to a TE node template.";
}
uses te-node-config-attributes;
```

```
} // te-node-config

grouping te-node-config-attributes {
  description "Configuration node attributes in a TE topology.";
  container te-node-attributes {
    description "Containing node attributes in a TE topology.";
    leaf admin-status {
      type te-types:te-admin-status;
      description
        "The administrative state of the link.";
    }
    uses te-node-connectivity-matrices;
    uses te-node-info-attributes;
  } // te-node-attributes
} // te-node-config-attributes

grouping te-node-config-attributes-template {
  description
    "Configuration node attributes for template in a TE topology.";
  container te-node-attributes {
    description "Containing node attributes in a TE topology.";
    leaf admin-status {
      type te-types:te-admin-status;
      description
        "The administrative state of the link.";
    }
    uses te-node-info-attributes;
  } // te-node-attributes
} // te-node-config-attributes-template

grouping te-node-connectivity-matrices {
  description "Connectivity matrix on a TE node.";
  container connectivity-matrices {
    description
      "Containing connectivity matrix on a TE node.";
    leaf number-of-entries {
      type uint16;
      description
        "The number of connectivity matrix entries.
        If this number is specified in the configuration request,
        the number is requested number of entries, which may not
```

```
        all be listed in the list;
        if this number is reported in the state data,
        the number is the current number of operational entries.";
    }
    uses te-types:label-set-info;
    uses connectivity-matrix-entry-path-attributes;
    list connectivity-matrix {
        key "id";
        description
            "Represents node's switching limitations, i.e. limitations
            in interconnecting network TE links across the node.";
        reference
            "RFC 7579: General Network Element Constraint Encoding
            for GMPLS-Controlled Networks.";
        leaf id {
            type uint32;
            description "Identifies the connectivity-matrix entry.";
        }
    } // connectivity-matrix
} // connectivity-matrices
} // te-node-connectivity-matrices

grouping te-node-connectivity-matrix-attributes {
    description
        "Termination point references of a connectivity matrix entry.";
    container from {
        description
            "Reference to source link termination point.";
        leaf tp-ref {
            type leafref {
                path "../.../nt:termination-point/nt:tp-id";
            }
            description
                "Relative reference to a termination point.";
        }
        uses te-types:label-set-info;
    }
    container to {
        description
            "Reference to destination link termination point.";
        leaf tp-ref {
```



```
    type leafref {
      path "../../../nt:termination-point/nt:tp-id";
    }
    description
      "Relative reference to a termination point.";
  }
  uses te-types:label-set-info;
}
uses connectivity-matrix-entry-path-attributes;
} // te-node-connectivity-matrix-attributes

grouping te-node-info-attributes {
  description
    "Advertised TE information attributes.";
  leaf domain-id {
    type uint32;
    description
      "Identifies the domain that this node belongs.
      This attribute is used to support inter-domain links.";
    reference
      "RFC 5152: A Per-Domain Path Computation Method for
      Establishing Inter-Domain Traffic Engineering (TE)
      Label Switched Paths (LSPs).
      RFC 5392: OSPF Extensions in Support of Inter-Autonomous
      System (AS) MPLS and GMPLS Traffic Engineering.
      RFC 5316: ISIS Extensions in Support of Inter-Autonomous
      System (AS) MPLS and GMPLS Traffic Engineering.";
  }
  leaf is-abstract {
    type empty;
    description
      "Present if the node is abstract, not present if the node
      is actual.";
  }
  leaf name {
    type string;
    description "Node name.";
  }
  leaf-list signaling-address {
    type inet:ip-address;
    description "Node signaling address.";
  }
}
```

```
    }
    container underlay-topology {
      if-feature te-topology-hierarchy;
      description
        "When an abstract node encapsulates a topology,
         the attributes in this container point to said topology.";
      uses nw:network-ref;
    }
  } // te-node-info-attributes

grouping te-node-state-derived {
  description "Node state attributes in a TE topology.";
  leaf oper-status {
    type te-types:te-oper-status;
    config false;
    description
      "The current operational state of the node.";
  }
  uses geolocation-container;
  leaf is-multi-access-dr {
    type empty;
    config false;
    description
      "The presence of this attribute indicates that this TE node
       is a pseudonode elected as a designated router.";
    reference
      "RFC 3630: Traffic Engineering (TE) Extensions to OSPF
       Version 2.
      RFC 1195: Use of OSI IS-IS for Routing in TCP/IP and Dual
       Environments.";
  }
  uses information-source-per-node-attributes;
  list information-source-entry {
    key "information-source information-source-instance";
    config false;
    description
      "A list of information sources learned, including the one
       used.";
    uses information-source-per-node-attributes;
    uses te-node-connectivity-matrices;
    uses te-node-info-attributes;
  }
}
```

```
    }
  } // te-node-state-derived

  grouping te-node-tunnel-termination-point-config {
    description
      "Termination capability of a tunnel termination point on a
      TE node.";
    uses te-node-tunnel-termination-point-config-attributes;
    container local-link-connectivities {
      description
        "Containing local link connectivity list for
        a tunnel termination point on a TE node.";
      leaf number-of-entries {
        type uint16;
        description
          "The number of local link connectivity list entries.
          If this number is specified in the configuration request,
          the number is requested number of entries, which may not
          all be listed in the list;
          if this number is reported in the state data,
          the number is the current number of operational entries.";
      }
      uses te-types:label-set-info;
      uses connectivity-matrix-entry-path-attributes;
    } // local-link-connectivities
  } // te-node-tunnel-termination-point-config

  grouping te-node-tunnel-termination-point-config-attributes {
    description
      "Configuration attributes of a tunnel termination point on a
      TE node.";
    leaf admin-status {
      type te-types:te-admin-status;
      description
        "The administrative state of the tunnel termination point.";
    }
    leaf name {
      type string;
      description
        "A descriptive name for the tunnel termination point.";
    }
  }
```

```
leaf switching-capability {
  type identityref {
    base te-types:switching-capabilities;
  }
  description
    "Switching Capability for this interface.";
}
leaf encoding {
  type identityref {
    base te-types:lsp-encoding-types;
  }
  description
    "Encoding supported by this interface.";
}
leaf-list inter-layer-lock-id {
  type uint32;
  description
    "Inter layer lock ID, used for path computation in a TE
    topology covering multiple layers or multiple regions.";
  reference
    "RFC 5212: Requirements for GMPLS-Based Multi-Region and
    Multi-Layer Networks (MRN/MLN).
    RFC 6001: Generalized MPLS (GMPLS) Protocol Extensions
    for Multi-Layer and Multi-Region Networks (MLN/MRN).";
}
leaf protection-type {
  type identityref {
    base te-types:lsp-protection-type;
  }
  description
    "The protection type that this tunnel termination point
    is capable of.";
}

container client-layer-adaptation {
  description
    "Containing capability information to support a client layer
    adaption in multi-layer topology.";
  list switching-capability {
    key "switching-capability encoding";
    description
```

```
    "List of supported switching capabilities";
  reference
    "RFC 6001: Generalized MPLS (GMPLS) Protocol Extensions
    for Multi-Layer and Multi-Region Networks (MLN/MRN).
    RFC 4202: Routing Extensions in Support of
    Generalized Multi-Protocol Label Switching (GMPLS).";
  leaf switching-capability {
    type identityref {
      base te-types:switching-capabilities;
    }
    description
      "Switching Capability for the client layer adaption.";
  }
  leaf encoding {
    type identityref {
      base te-types:lsp-encoding-types;
    }
    description
      "Encoding supported by the client layer adaption.";
  }
  uses te-types:te-bandwidth;
}
}
} // te-node-tunnel-termination-point-config-attributes

grouping te-node-tunnel-termination-point-llc-list {
  description
    "Local link connectivity list of a tunnel termination
    point on a TE node.";
  list local-link-connectivity {
    key "link-tp-ref";
    description
      "The termination capabilities between
      tunnel-termination-point and link termination-point.
      The capability information can be used to compute
      the tunnel path.
      The Interface Adjustment Capability Descriptors (IACD)
      (defined in RFC 6001) on each link-tp can be derived from
      this local-link-connectivity list.";
  }
  reference
    "RFC 6001: Generalized MPLS (GMPLS) Protocol Extensions
```

```
    for Multi-Layer and Multi-Region Networks (MLN/MRN).";

leaf link-tp-ref {
  type leafref {
    path "../../../../../nt:termination-point/nt:tp-id";
  }
  description
    "Link termination point.";
}
uses te-types:label-set-info;
uses connectivity-matrix-entry-path-attributes;
} // local-link-connectivity
} // te-node-tunnel-termination-point-config

grouping te-path-element {
  description
    "A group of attributes defining an element in a TE path
    such as TE node, TE link, TE atomic resource or label.";
  uses te-types:explicit-route-hop;
} // te-path-element

grouping te-termination-point-augment {
  description
    "Augmentation for TE termination point.";
  leaf te-tp-id {
    type te-types:te-tp-id;
    description
      "An identifier to uniquely identify a TE termination
      point.";
  }
  container te {
    must "../te-tp-id";
    presence "TE support.";
    description
      "Indicates TE support.";

    uses te-termination-point-config;
    leaf oper-status {
      type te-types:te-oper-status;
      config false;
      description

```

```
        "The current operational state of the link termination
        point.";
    }
    uses geolocation-container;
} // te
} // te-termination-point-augment

grouping te-termination-point-config {
    description
        "TE termination point configuration grouping.";
    leaf admin-status {
        type te-types:te-admin-status;
        description
            "The administrative state of the link termination point.";
    }
    leaf name {
        type string;
        description
            "A descriptive name for the link termination point.";
    }
    uses interface-switching-capability-list;
    leaf inter-domain-plug-id {
        type binary;
        description
            "A topology-wide unique number that identifies on the
            network a connectivity supporting a given inter-domain
            TE link. This is more flexible alternative to specifying
            remote-te-node-id and remote-te-link-tp-id on a TE link,
            when the provider does not know remote-te-node-id and
            remote-te-link-tp-id or need to give client the
            flexibility to mix-n-match multiple topologies.";
    }
    leaf-list inter-layer-lock-id {
        type uint32;
        description
            "Inter layer lock ID, used for path computation in a TE
            topology covering multiple layers or multiple regions.";
        reference
            "RFC 5212: Requirements for GMPLS-Based Multi-Region and
            Multi-Layer Networks (MRN/MLN).
            RFC 6001: Generalized MPLS (GMPLS) Protocol Extensions
```

```
        for Multi-Layer and Multi-Region Networks (MLN/MRN).";
    }
} // te-termination-point-config

grouping te-topologies-augment {
  description
    "Augmentation for TE topologies.";
  container te {
    presence "TE support.";
    description
      "Indicates TE support.";

    container templates {
      description
        "Configuration parameters for templates used for TE
        topology.";

      list node-template {
        if-feature template;
        key "name";
        leaf name {
          type te-types:te-template-name;
          description
            "The name to identify a TE node template.";
        }
        description
          "The list of TE node templates used to define sharable
          and reusable TE node attributes.";
        uses template-attributes;
        uses te-node-config-attributes-template;
      } // node-template

      list link-template {
        if-feature template;
        key "name";
        leaf name {
          type te-types:te-template-name;
          description
            "The name to identify a TE link template.";
        }
        description

```



```
        "The list of TE link templates used to define sharable
        and reusable TE link attributes.";
        uses template-attributes;
        uses te-link-config-attributes;
    } // link-template
} // templates
} // te
} // te-topologies-augment

grouping te-topology-augment {
    description
        "Augmentation for TE topology.";
    uses te-types:te-topology-identifier;

    container te {
        must "../te-topology-identifier/provider-id"
            + " and ../te-topology-identifier/client-id"
            + " and ../te-topology-identifier/topology-id";
        presence "TE support.";
        description
            "Indicates TE support.";

        uses te-topology-config;
        uses geolocation-container;
    } // te
} // te-topology-augment

grouping te-topology-config {
    description
        "TE topology configuration grouping.";
    leaf name {
        type string;
        description
            "Name of the TE topology. This attribute is optional and can
            be specified by the operator to describe the TE topology,
            which can be useful when network-id is not descriptive
            and not modifiable because of being generated by the
            system.";
    }
    leaf preference {
        type uint8 {
```

```
        range "1..255";
    }
    description
        "Specifies a preference for this topology. A lower number
        indicates a higher preference.";
}
leaf optimization-criterion {
    type identityref {
        base te-types:objective-function-type;
    }
    description
        "Optimization criterion applied to this topology.";
    reference
        "RFC 3272: Overview and Principles of Internet Traffic
        Engineering.";
}
list nsrlg {
    if-feature nsrlg;
    key "id";
    description
        "List of NSRLGs (Not Sharing Risk Link Groups).";
    reference
        "RFC 4872: RSVP-TE Extensions in Support of End-to-End
        Generalized Multi-Protocol Label Switching (GMPLS)
        Recovery";
    leaf id {
        type uint32;
        description
            "Identify the NSRLG entry.";
    }
    leaf disjointness {
        type te-types:te-path-disjointness;
        description
            "The type of resource disjointness.";
    }
} // nsrlg
} // te-topology-config

grouping template-attributes {
    description
        "Common attributes for all templates.";
```

```
leaf priority {
  type uint16;
  description
    "The preference value to resolve conflicts between different
    templates. When two or more templates specify values for
    one configuration attribute, the value from the template
    with the highest priority is used.
    A lower number indicates a higher priority. The highest
    priority is 0.";
}
leaf reference-change-policy {
  type enumeration {
    enum no-action {
      description
        "When an attribute changes in this template, the
        configuration node referring to this template does
        not take any action.";
    }
    enum not-allowed {
      description
        "When any configuration object has a reference to this
        template, changing this template is not allowed.";
    }
    enum cascade {
      description
        "When an attribute changes in this template, the
        configuration object referring to this template applies
        the new attribute value to the corresponding
        configuration.";
    }
  }
  description
    "This attribute specifies the action taken to a configuration
    node that has a reference to this template.";
}
} // template-attributes

/*
 * Data nodes
 */
augment "/nw:networks/nw:network/nw:network-types" {
```

```
description
  "Introduce new network type for TE topology.";
container te-topology {
  presence "Indicates TE topology.";
  description
    "Its presence identifies the TE topology type.";
}
}

augment "/nw:networks" {
  description
    "Augmentation parameters for TE topologies.";
  uses te-topologies-augment;
}

augment "/nw:networks/nw:network" {
  when "nw:network-types/tet:te-topology" {
    description
      "Augmentation parameters apply only for networks with
      TE topology type.";
  }
  description
    "Configuration parameters for TE topology.";
  uses te-topology-augment;
}

augment "/nw:networks/nw:network/nw:node" {
  when "../nw:network-types/tet:te-topology" {
    description
      "Augmentation parameters apply only for networks with
      TE topology type.";
  }
  description
    "Configuration parameters for TE at node level.";
  leaf te-node-id {
    type te-types:te-node-id;
    description
      "The identifier of a node in the TE topology.
      A node is specific to a topology to which it belongs.";
  }
  container te {
```

```
    must "../te-node-id" {
      description
        "te-node-id is mandatory.";
    }
    must "count(..nw:supporting-node)<=1" {
      description
        "For a node in a TE topology, there cannot be more
        than 1 supporting node. If multiple nodes are abstracted,
        the underlay-topology is used.";
    }
    presence "TE support.";
    description
      "Indicates TE support.";
    uses te-node-augment;
  } // te
}

augment "/nw:networks/nw:network/nt:link" {
  when "../nw:network-types/tet:te-topology" {
    description
      "Augmentation parameters apply only for networks with
      TE topology type.";
  }
  description
    "Configuration parameters for TE at link level.";
  container te {
    must "count(..nt:supporting-link)<=1" {
      description
        "For a link in a TE topology, there cannot be more
        than 1 supporting link. If one or more link paths are
        abstracted, the underlay is used.";
    }
    presence "TE support.";
    description
      "Indicates TE support.";
    uses te-link-augment;
  } // te
}

augment "/nw:networks/nw:network/nw:node/"
  + "nt:termination-point" {
```

```
when "../../../nw:network-types/tet:te-topology" {
  description
    "Augmentation parameters apply only for networks with
    TE topology type.";
}
description
  "Configuration parameters for TE at termination point level.";
uses te-termination-point-augment;
}

augment
  "/nw:networks/nw:network/nt:link/te/bundle-stack-level/"
  + "bundle/bundled-links/bundled-link" {
  when "../../../nw:network-types/tet:te-topology" {
    description
      "Augmentation parameters apply only for networks with
      TE topology type.";
  }
  description
    "Augment TE link bundled link.";
  leaf src-tp-ref {
    type leafref {
      path "../../../nw:node[nw:node-id = "
        + "current()/../../../nt:source/"
        + "nt:source-node]/"
        + "nt:termination-point/nt:tp-id";
      require-instance true;
    }
    description
      "Reference to another TE termination point on the
      same source node.";
  }
  leaf des-tp-ref {
    type leafref {
      path "../../../nw:node[nw:node-id = "
        + "current()/../../../nt:destination/"
        + "nt:dest-node]/"
        + "nt:termination-point/nt:tp-id";
      require-instance true;
    }
    description
```

```
        "Reference to another TE termination point on the
          same destination node.";
    }
}

augment
  "/nw:networks/nw:network/nw:node/te/"
  + "information-source-entry/connectivity-matrices/"
  + "connectivity-matrix" {
  when "../../../nw:network-types/tet:te-topology" {
    description
      "Augmentation parameters apply only for networks with
        TE topology type.";
  }
  description
    "Augment TE node connectivity-matrix.";
  uses te-node-connectivity-matrix-attributes;
}

augment
  "/nw:networks/nw:network/nw:node/te/te-node-attributes/"
  + "connectivity-matrices/connectivity-matrix" {
  when "../../../nw:network-types/tet:te-topology" {
    description
      "Augmentation parameters apply only for networks with
        TE topology type.";
  }
  description
    "Augment TE node connectivity-matrix.";
  uses te-node-connectivity-matrix-attributes;
}

augment
  "/nw:networks/nw:network/nw:node/te/"
  + "tunnel-termination-point/local-link-connectivities" {
  when "../../../nw:network-types/tet:te-topology" {
    description
      "Augmentation parameters apply only for networks with
        TE topology type.";
  }
  description
```

```
    "Augment TE node tunnel termination point LLCs
    (Local Link Connectivities).";
    uses te-node-tunnel-termination-point-llc-list;
  }
}
<CODE ENDS>
```

## 8. Security Considerations

The YANG module specified in this document defines a schema for data that is designed to be accessed via network management protocols such as NETCONF [[RFC6241](#)] or RESTCONF [[RFC8040](#)]. The lowest NETCONF layer is the secure transport layer, and the mandatory-to-implement secure transport is Secure Shell (SSH) [[RFC6242](#)]. The lowest RESTCONF layer is HTTPS, and the mandatory-to-implement secure transport is TLS [[RFC8446](#)].

The Network Configuration Access Control Model (NACM) [[RFC8341](#)] provides the means to restrict access for particular NETCONF or RESTCONF users to a preconfigured subset of all available NETCONF or RESTCONF protocol operations and content.

There are a number of data nodes defined in this YANG module that are writable/creatable/deletable (i.e., config true, which is the default). These data nodes may be considered sensitive or vulnerable in some network environments. Write operations (e.g., edit-config) to these data nodes without proper protection can have a negative effect on network operations. These are the subtrees and data nodes and their sensitivity/vulnerability:

- o /nw:networks/nw:network/nw:network-types/tet:te-topology  
This subtree specifies the TE topology type. Modifying the configurations can make TE topology type invalid. By such modifications, a malicious attacker may disable the TE capabilities on the related networks and cause traffic disrupted or misrouted.
- o /nw:networks/tet:te  
This subtree specifies the TE node templates and TE link templates. Modifying the configurations in this subtree will change the related future TE configurations. By such modifications, a malicious attacker may change the TE capabilities scheduled at a future time, to cause traffic disrupted or misrouted.



- o /nw:networks/nw:network  
This subtree specifies the topology-wide configurations, including the TE topology ID and topology-wide policies. Modifying the configurations in this subtree can add, remove, or modify TE topologies. By adding a TE topology, a malicious attacker may create an unauthorized traffic network. By removing or modifying a TE topology, a malicious attacker may cause traffic disabled or misrouted in the specified TE topology. Such traffic changes may also affect the traffic in the connected TE topologies.
- o /nw:networks/nw:network/nw:node  
This subtree specifies the configurations for TE nodes. Modifying the configurations in this subtree can add, remove, or modify TE nodes. By adding a TE node, a malicious attacker may create an unauthorized traffic path. By removing or modifying a TE node, a malicious attacker may cause traffic disabled or misrouted in the specified TE node. Such traffic changes may also affect the traffic on the surrounding TE nodes and TE links in this TE topology and the connected TE topologies.
- o /nw:networks/nw:network/nt:link/tet:te  
This subtree specifies the configurations for TE links. Modifying the configurations in this subtree can add, remove, or modify TE links. By adding a TE link, a malicious attacker may create an unauthorized traffic path. By removing or modifying a TE link, a malicious attacker may cause traffic disabled or misrouted on the specified TE link. Such traffic changes may also affect the traffic on the surrounding TE nodes and TE links in this TE topology and the connected TE topologies.
- o /nw:networks/nw:network/nw:node/nt:termination-point  
This subtree specifies the configurations of TE link termination points. Modifying the configurations in this subtree can add, remove, or modify TE link termination points. By adding a TE link termination point, a malicious attacker may create an unauthorized traffic path. By removing or modifying a TE link termination point, a malicious attacker may cause traffic disabled or misrouted on the specified TE link termination point. Such traffic changes may also affect the traffic on the surrounding TE nodes and TE links in this TE topology and the connected TE topologies.

Some of the readable data nodes in this YANG module may be considered sensitive or vulnerable in some network environments. It is thus important to control read access (e.g., via get, get-config, or notification) to these data nodes. These are the subtrees and data nodes and their sensitivity/vulnerability:



- o /nw:networks/nw:network/nw:network-types/tet:te-topology  
Unauthorized access to this subtree can disclose the TE topology type.
- o /nw:networks/tet:te  
Unauthorized access to this subtree can disclose the TE node templates and TE link templates.
- o /nw:networks/nw:network  
Unauthorized access to this subtree can disclose the topology-wide configurations, including the TE topology ID, the topology-wide policies, and the topology geolocation.
- o /nw:networks/nw:network/nw:node  
Unauthorized access to this subtree can disclose the operational state information of TE nodes.
- o /nw:networks/nw:network/nt:link/tet:te  
Unauthorized access to this subtree can disclose the operational state information of TE links.
- o /nw:networks/nw:network/nw:node/nt:termination-point  
Unauthorized access to this subtree can disclose the operational state information of TE link termination points.

## 9. IANA Considerations

This document registers the following URIs in the IETF XML registry [[RFC3688](#)]. Following the format in [[RFC3688](#)], the following registration is requested to be made.

URI: urn:ietf:params:xml:ns:yang:ietf-te-topology  
Registrant Contact: The IESG.  
XML: N/A, the requested URI is an XML namespace.

URI: urn:ietf:params:xml:ns:yang:ietf-te-topology-state  
Registrant Contact: The IESG.  
XML: N/A, the requested URI is an XML namespace.

This document registers a YANG module in the YANG Module Names registry [[RFC7950](#)].

name: ietf-te-topology  
namespace: urn:ietf:params:xml:ns:yang:ietf-te-topology  
prefix: tet  
reference: RFC XXXX



name: ietf-te-topology-state  
namespace: urn:ietf:params:xml:ns:yang:ietf-te-topology-state  
prefix: tet-s  
reference: RFC XXXX

## **10. References**

### **10.1. Normative References**

- [RFC2119] Bradner, S., "Key words for use in RFCs to Indicate Requirement Levels", [BCP 14](#), [RFC 2119](#), DOI 10.17487/RFC2119, March 1997, <<https://www.rfc-editor.org/info/rfc2119>>.
- [RFC3688] Mealling, M., "The IETF XML Registry", [BCP 81](#), [RFC 3688](#), DOI 10.17487/RFC3688, January 2004, <<https://www.rfc-editor.org/info/rfc3688>>.
- [RFC3945] Mannie, E., Ed., "Generalized Multi-Protocol Label Switching (GMPLS) Architecture", [RFC 3945](#), DOI 10.17487/RFC3945, October 2004, <<https://www.rfc-editor.org/info/rfc3945>>.
- [RFC6241] Enns, R., Ed., Bjorklund, M., Ed., Schoenwaelder, J., Ed., and A. Bierman, Ed., "Network Configuration Protocol (NETCONF)", [RFC 6241](#), DOI 10.17487/RFC6241, June 2011, <<https://www.rfc-editor.org/info/rfc6241>>.
- [RFC6242] Wasserman, M., "Using the NETCONF Protocol over Secure Shell (SSH)", [RFC 6242](#), DOI 10.17487/RFC6242, June 2011, <<https://www.rfc-editor.org/info/rfc6242>>.
- [RFC6991] Schoenwaelder, J., Ed., "Common YANG Data Types", [RFC 6991](#), DOI 10.17487/RFC6991, July 2013, <<https://www.rfc-editor.org/info/rfc6991>>.
- [RFC7926] Farrel, A., Ed., Drake, J., Bitar, N., Swallow, G., Ceccarelli, D., and X. Zhang, "Problem Statement and Architecture for Information Exchange between Interconnected Traffic-Engineered Networks", [BCP 206](#), [RFC 7926](#), DOI 10.17487/RFC7926, July 2016, <<https://www.rfc-editor.org/info/rfc7926>>.
- [RFC7950] Bjorklund, M., Ed., "The YANG 1.1 Data Modeling Language", [RFC 7950](#), DOI 10.17487/RFC7950, August 2016, <<https://www.rfc-editor.org/info/rfc7950>>.



- [RFC8040] Bierman, A., Bjorklund, M., and K. Watsen, "RESTCONF Protocol", [RFC 8040](#), DOI 10.17487/RFC8040, January 2017, <<https://www.rfc-editor.org/info/rfc8040>>.
- [RFC8174] Leiba, B., "Ambiguity of Uppercase vs Lowercase in [RFC 2119](#) Key Words", [BCP 14](#), [RFC 8174](#), DOI 10.17487/RFC8174, May 2017, <<https://www.rfc-editor.org/info/rfc8174>>.
- [RFC8341] Bierman, A. and M. Bjorklund, "Network Configuration Access Control Model", STD 91, [RFC 8341](#), DOI 10.17487/RFC8341, March 2018, <<https://www.rfc-editor.org/info/rfc8341>>.
- [RFC8342] Bjorklund, M., Schoenwaelder, J., Shafer, P., Watsen, K., and R. Wilton, "Network Management Datastore Architecture (NMDA)", [RFC 8342](#), DOI 10.17487/RFC8342, March 2018, <<https://www.rfc-editor.org/info/rfc8342>>.
- [RFC8345] Clemm, A., Medved, J., Varga, R., Bahadur, N., Ananthakrishnan, H., and X. Liu, "A YANG Data Model for Network Topologies", [RFC 8345](#), DOI 10.17487/RFC8345, March 2018, <<https://www.rfc-editor.org/info/rfc8345>>.
- [RFC8446] Rescorla, E., "The Transport Layer Security (TLS) Protocol Version 1.3", [RFC 8446](#), DOI 10.17487/RFC8446, August 2018, <<https://www.rfc-editor.org/info/rfc8446>>.
- [I-D.ietf-teas-yang-te-types]  
Saad, T., Gandhi, R., Liu, X., Beeram, V., and I. Bryskin, "Traffic Engineering Common YANG Types", [draft-ietf-teas-yang-te-types-08](#) (work in progress), April 2019.

## **10.2. Informative References**

- [G.709] ITU-T, "Interfaces for the optical transport network", ITU-T Recommendation G.709, June 2016.
- [G.805] ITU-T, "Generic functional architecture of transport networks", ITU-T Recommendation G.805, March 2000.
- [G.872] ITU-T, "Architecture of optical transport networks", ITU-T Recommendation G.872, January 2017.
- [G.8080] ITU-T, "Architecture for the automatically switched optical network", ITU-T Recommendation G.8080, February 2012.





- [RFC1195] Callon, R., "Use of OSI IS-IS for routing in TCP/IP and dual environments", [RFC 1195](#), DOI 10.17487/RFC1195, December 1990, <<https://www.rfc-editor.org/info/rfc1195>>.
- [RFC2702] Awduche, D., Malcolm, J., Agogbua, J., O'Dell, M., and J. McManus, "Requirements for Traffic Engineering Over MPLS", [RFC 2702](#), DOI 10.17487/RFC2702, September 1999, <<https://www.rfc-editor.org/info/rfc2702>>.
- [RFC3209] Awduche, D., Berger, L., Gan, D., Li, T., Srinivasan, V., and G. Swallow, "RSVP-TE: Extensions to RSVP for LSP Tunnels", [RFC 3209](#), DOI 10.17487/RFC3209, December 2001, <<https://www.rfc-editor.org/info/rfc3209>>.
- [RFC3272] Awduche, D., Chiu, A., Elwalid, A., Widjaja, I., and X. Xiao, "Overview and Principles of Internet Traffic Engineering", [RFC 3272](#), DOI 10.17487/RFC3272, May 2002, <<https://www.rfc-editor.org/info/rfc3272>>.
- [RFC3471] Berger, L., Ed., "Generalized Multi-Protocol Label Switching (GMPLS) Signaling Functional Description", [RFC 3471](#), DOI 10.17487/RFC3471, January 2003, <<https://www.rfc-editor.org/info/rfc3471>>.
- [RFC3630] Katz, D., Kompella, K., and D. Yeung, "Traffic Engineering (TE) Extensions to OSPF Version 2", [RFC 3630](#), DOI 10.17487/RFC3630, September 2003, <<https://www.rfc-editor.org/info/rfc3630>>.
- [RFC3785] Le Faucheur, F., Uppili, R., Vedrenne, A., Merckx, P., and T. Telkamp, "Use of Interior Gateway Protocol (IGP) Metric as a second MPLS Traffic Engineering (TE) Metric", [BCP 87](#), [RFC 3785](#), DOI 10.17487/RFC3785, May 2004, <<https://www.rfc-editor.org/info/rfc3785>>.
- [RFC4201] Kompella, K., Rekhter, Y., and L. Berger, "Link Bundling in MPLS Traffic Engineering (TE)", [RFC 4201](#), DOI 10.17487/RFC4201, October 2005, <<https://www.rfc-editor.org/info/rfc4201>>.
- [RFC4202] Kompella, K., Ed. and Y. Rekhter, Ed., "Routing Extensions in Support of Generalized Multi-Protocol Label Switching (GMPLS)", [RFC 4202](#), DOI 10.17487/RFC4202, October 2005, <<https://www.rfc-editor.org/info/rfc4202>>.
- [RFC4203] Kompella, K., Ed. and Y. Rekhter, Ed., "OSPF Extensions in Support of Generalized Multi-Protocol Label Switching



- (GMPLS)", [RFC 4203](#), DOI 10.17487/RFC4203, October 2005, <<https://www.rfc-editor.org/info/rfc4203>>.
- [RFC4206] Kompella, K. and Y. Rekhter, "Label Switched Paths (LSP) Hierarchy with Generalized Multi-Protocol Label Switching (GMPLS) Traffic Engineering (TE)", [RFC 4206](#), DOI 10.17487/RFC4206, October 2005, <<https://www.rfc-editor.org/info/rfc4206>>.
- [RFC4872] Lang, J., Ed., Rekhter, Y., Ed., and D. Papadimitriou, Ed., "RSVP-TE Extensions in Support of End-to-End Generalized Multi-Protocol Label Switching (GMPLS) Recovery", [RFC 4872](#), DOI 10.17487/RFC4872, May 2007, <<https://www.rfc-editor.org/info/rfc4872>>.
- [RFC5152] Vasseur, JP., Ed., Ayyangar, A., Ed., and R. Zhang, "A Per-Domain Path Computation Method for Establishing Inter-Domain Traffic Engineering (TE) Label Switched Paths (LSPs)", [RFC 5152](#), DOI 10.17487/RFC5152, February 2008, <<https://www.rfc-editor.org/info/rfc5152>>.
- [RFC5212] Shiomoto, K., Papadimitriou, D., Le Roux, JL., Vigoureux, M., and D. Brungard, "Requirements for GMPLS-Based Multi-Region and Multi-Layer Networks (MRN/MLN)", [RFC 5212](#), DOI 10.17487/RFC5212, July 2008, <<https://www.rfc-editor.org/info/rfc5212>>.
- [RFC5305] Li, T. and H. Smit, "IS-IS Extensions for Traffic Engineering", [RFC 5305](#), DOI 10.17487/RFC5305, October 2008, <<https://www.rfc-editor.org/info/rfc5305>>.
- [RFC5316] Chen, M., Zhang, R., and X. Duan, "ISIS Extensions in Support of Inter-Autonomous System (AS) MPLS and GMPLS Traffic Engineering", [RFC 5316](#), DOI 10.17487/RFC5316, December 2008, <<https://www.rfc-editor.org/info/rfc5316>>.
- [RFC5329] Ishiguro, K., Manral, V., Davey, A., and A. Lindem, Ed., "Traffic Engineering Extensions to OSPF Version 3", [RFC 5329](#), DOI 10.17487/RFC5329, September 2008, <<https://www.rfc-editor.org/info/rfc5329>>.
- [RFC5392] Chen, M., Zhang, R., and X. Duan, "OSPF Extensions in Support of Inter-Autonomous System (AS) MPLS and GMPLS Traffic Engineering", [RFC 5392](#), DOI 10.17487/RFC5392, January 2009, <<https://www.rfc-editor.org/info/rfc5392>>.
- [RFC6001] Papadimitriou, D., Vigoureux, M., Shiomoto, K., Brungard,



- D., and JL. Le Roux, "Generalized MPLS (GMPLS) Protocol Extensions for Multi-Layer and Multi-Region Networks (MLN/MRN)", [RFC 6001](#), DOI 10.17487/RFC6001, October 2010, <<https://www.rfc-editor.org/info/rfc6001>>.
- [RFC7308] Osborne, E., "Extended Administrative Groups in MPLS Traffic Engineering (MPLS-TE)", [RFC 7308](#), DOI 10.17487/RFC7308, July 2014, <<https://www.rfc-editor.org/info/rfc7308>>.
- [RFC7471] Giacalone, S., Ward, D., Drake, J., Atlas, A., and S. Previdi, "OSPF Traffic Engineering (TE) Metric Extensions", [RFC 7471](#), DOI 10.17487/RFC7471, March 2015, <<https://www.rfc-editor.org/info/rfc7471>>.
- [RFC7579] Bernstein, G., Ed., Lee, Y., Ed., Li, D., Imajuku, W., and J. Han, "General Network Element Constraint Encoding for GMPLS-Controlled Networks", [RFC 7579](#), DOI 10.17487/RFC7579, June 2015, <<https://www.rfc-editor.org/info/rfc7579>>.
- [RFC7752] Gredler, H., Ed., Medved, J., Previdi, S., Farrel, A., and S. Ray, "North-Bound Distribution of Link-State and Traffic Engineering (TE) Information Using BGP", [RFC 7752](#), DOI 10.17487/RFC7752, March 2016, <<https://www.rfc-editor.org/info/rfc7752>>.
- [RFC8340] Bjorklund, M. and L. Berger, Ed., "YANG Tree Diagrams", [BCP 215](#), [RFC 8340](#), DOI 10.17487/RFC8340, March 2018, <<https://www.rfc-editor.org/info/rfc8340>>.
- [I-D.ietf-netconf-subscribed-notifications]  
Voit, E., Clemm, A., Prieto, A., Nilsen-Nygaard, E., and A. Tripathy, "Customized Subscriptions to a Publisher's Event Streams", [draft-ietf-netconf-subscribed-notifications-23](#) (work in progress), February 2019.
- [I-D.ietf-netconf-yang-push]  
Clemm, A., Voit, E., Prieto, A., Tripathy, A., Nilsen-Nygaard, E., Bierman, A., and B. Lengyel, "YANG Datastore Subscription", [draft-ietf-netconf-yang-push-22](#) (work in progress), February 2019.
- [I-D.liu-netmod-yang-schedule]  
Liu, X., Bryskin, I., Beeram, V., Saad, T., Shah, H., and O. Dios, "A YANG Data Model for Configuration Scheduling", [draft-liu-netmod-yang-schedule-05](#) (work in progress),



March 2018.

[I-D.ietf-ccamp-wson-yang]

Lee, Y., Dhody, D., Zhang, X., Guo, A., Lopezalvarez, V., King, D., Yoon, B., and R. Vilata, "A Yang Data Model for WSON Optical Networks", [draft-ietf-ccamp-wson-yang-20](#) (work in progress), March 2019.

[I-D.ietf-ccamp-otn-topo-yang]

zhenghaomian@huawei.com, z., Guo, A., Busi, I., Sharma, A., Liu, X., Belotti, S., Xu, Y., Wang, L., and O. Dios, "A YANG Data Model for Optical Transport Network Topology", [draft-ietf-ccamp-otn-topo-yang-06](#) (work in progress), February 2019.

[I-D.ietf-teas-yang-l3-te-topo]

Liu, X., Bryskin, I., Beeram, V., Saad, T., Shah, H., and O. Dios, "YANG Data Model for Layer 3 TE Topologies", [draft-ietf-teas-yang-l3-te-topo-04](#) (work in progress), March 2019.

[I-D.ietf-teas-te-topo-and-tunnel-modeling]

Bryskin, I., Beeram, V., Saad, T., and X. Liu, "TE Topology and Tunnel Modeling for Transport Networks", [draft-ietf-teas-te-topo-and-tunnel-modeling-03](#) (work in progress), October 2018.

## **11. Acknowledgments**

The authors would like to thank Lou Berger, Sue Hares, Mazen Khaddam, Cyril Margaria and Zafar Ali for participating in design discussions and providing valuable insights.

**Appendix A. Complete Model Tree Structure**

```

module: ietf-te-topology
  augment /nw:networks/nw:network/nw:network-types:
    +--rw te-topology!
  augment /nw:networks:
    +--rw te!
      +--rw templates
        +--rw node-template* [name] {template}?
          | +--rw name
          | |       te-types:te-template-name
          | +--rw priority?          uint16
          | +--rw reference-change-policy?  enumeration
          | +--rw te-node-attributes
          |   +--rw admin-status?          te-types:te-admin-status
          |   +--rw domain-id?            uint32
          |   +--rw is-abstract?          empty
          |   +--rw name?                 string
          |   +--rw signaling-address*    inet:ip-address
          |   +--rw underlay-topology {te-topology-hierarchy}?
          |     +--rw network-ref?
          |       -> /nw:networks/network/network-id
        +--rw link-template* [name] {template}?
          +--rw name
          |       te-types:te-template-name
          +--rw priority?          uint16
          +--rw reference-change-policy?  enumeration
          +--rw te-link-attributes
            +--rw access-type?
            |       te-types:te-link-access-type
            +--rw external-domain
            | +--rw network-ref?
            | |       -> /nw:networks/network/network-id
            | +--rw remote-te-node-id?    te-types:te-node-id
            | +--rw remote-te-link-tp-id? te-types:te-tp-id
            +--rw is-abstract?          empty
            +--rw name?                 string
            +--rw underlay {te-topology-hierarchy}?
            | +--rw enabled?             boolean
            | +--rw primary-path
            | | +--rw network-ref?

```



```

| | |         -> /nw:networks/network/network-id
| | +--rw path-element* [path-element-id]
| |   +--rw path-element-id          uint32
| |   +--rw (type)?
| |     +--:(numbered-node-hop)
| |       | +--rw numbered-node-hop
| |         | +--rw node-id      te-node-id
| |         | +--rw hop-type?    te-hop-type
| |     +--:(numbered-link-hop)
| |       | +--rw numbered-link-hop
| |         | +--rw link-tp-id    te-tp-id
| |         | +--rw hop-type?    te-hop-type
| |         | +--rw direction?
| |         |           te-link-direction
| |     +--:(unnumbered-link-hop)
| |       | +--rw unnumbered-link-hop
| |         | +--rw link-tp-id    te-tp-id
| |         | +--rw node-id      te-node-id
| |         | +--rw hop-type?    te-hop-type
| |         | +--rw direction?
| |         |           te-link-direction
| |     +--:(as-number)
| |       | +--rw as-number-hop
| |         | +--rw as-number    inet:as-number
| |         | +--rw hop-type?    te-hop-type
| |     +--:(label)
| |       +--rw label-hop
| |         +--rw te-label
| |           +--rw (technology)?
| |             | +--:(generic)
| |             |   +--rw generic?
| |             |     rt-
| |             |
| |             +--rw direction?
| |               te-label-direction
| | +--rw backup-path* [index]
| |   +--rw index          uint32
| |   +--rw network-ref?
| |     |         -> /nw:networks/network/network-id
| |     +--rw path-element* [path-element-id]
| |       +--rw path-element-id          uint32

```

types:generalized-label

```

| | +--rw (type)?
| |   +---:(numbered-node-hop)
| |     | +--rw numbered-node-hop
| |       | +--rw node-id      te-node-id
| |       | +--rw hop-type?   te-hop-type
| |     +---:(numbered-link-hop)
| |       | +--rw numbered-link-hop
| |         | +--rw link-tp-id  te-tp-id
| |         | +--rw hop-type?   te-hop-type
| |         | +--rw direction?
| |           | te-link-direction
| |     +---:(unnumbered-link-hop)
| |       | +--rw unnumbered-link-hop
| |         | +--rw link-tp-id  te-tp-id
| |         | +--rw node-id      te-node-id
| |         | +--rw hop-type?   te-hop-type
| |         | +--rw direction?
| |           | te-link-direction
| |     +---:(as-number)
| |       | +--rw as-number-hop
| |         | +--rw as-number    inet:as-number
| |         | +--rw hop-type?   te-hop-type
| |     +---:(label)
| |       +--rw label-hop
| |         +--rw te-label
| |           +--rw (technology)?
| |             | +---:(generic)
| |             |   +--rw generic?
| |             |   | rt-
types:generalized-label
| |           +--rw direction?
| |             | te-label-direction
| |     +--rw protection-type?      identityref
| |     +--rw tunnel-termination-points
| |       | +--rw source?          binary
| |       | +--rw destination?    binary
| |     +--rw tunnels
| |       +--rw sharing?          boolean
| |       +--rw tunnel* [tunnel-name]
| |         +--rw tunnel-name     string
| |         +--rw sharing?        boolean

```

```

+--rw admin-status?
|   te-types:te-admin-status
+--rw link-index?                               uint64
+--rw administrative-group?
|   te-types:admin-groups
+--rw interface-switching-capability*
|   [switching-capability encoding]
|   +--rw switching-capability   identityref
|   +--rw encoding                identityref
|   +--rw max-lsp-bandwidth* [priority]
|       +--rw priority           uint8
|       +--rw te-bandwidth
|           +--rw (technology)?
|               +--:(generic)
|                   +--rw generic?   te-bandwidth
+--rw label-restrictions
|   +--rw label-restriction* [index]
|       +--rw restriction?     enumeration
|       +--rw index            uint32
|       +--rw label-start
|           |   +--rw te-label
|           |       +--rw (technology)?
|           |           |   +--:(generic)
|           |               |   +--rw generic?
|           |                   |   rt-types:generalized-label
|           |                       +--rw direction?   te-label-direction
|       +--rw label-end
|           |   +--rw te-label
|           |       +--rw (technology)?
|           |           |   +--:(generic)
|           |               |   +--rw generic?
|           |                   |   rt-types:generalized-label
|           |                       +--rw direction?   te-label-direction
|       +--rw label-step
|           |   +--rw (technology)?
|           |       +--:(generic)
|           |           +--rw generic?   int32
|       +--rw range-bitmap?   yang:hex-string
+--rw link-protection-type?   identityref
+--rw max-link-bandwidth
|   +--rw te-bandwidth

```

```

    |     +--rw (technology)?
    |     +---:(generic)
    |         +--rw generic?   te-bandwidth
+--rw max-resv-link-bandwidth
| +--rw te-bandwidth
|     +--rw (technology)?
|     +---:(generic)
|         +--rw generic?   te-bandwidth
+--rw unreserved-bandwidth* [priority]
| +--rw priority           uint8
| +--rw te-bandwidth
|     +--rw (technology)?
|     +---:(generic)
|         +--rw generic?   te-bandwidth
+--rw te-default-metric?           uint32
+--rw te-delay-metric?             uint32
+--rw te-igp-metric?               uint32
+--rw te-srlgs
| +--rw value*   te-types:srlg
+--rw te-nsrlgs {nsrlg}?
    +--rw id*   uint32
augment /nw:networks/nw:network:
+--rw te-topology-identifier
| +--rw provider-id?   te-global-id
| +--rw client-id?    te-global-id
| +--rw topology-id?  te-topology-id
+--rw te!
    +--rw name?           string
    +--rw preference?    uint8
    +--rw optimization-criterion?  identityref
    +--rw nsrlg* [id] {nsrlg}?
    | +--rw id           uint32
    | +--rw disjointness?  te-types:te-path-disjointness
+--ro geolocation
    +--ro altitude?     int64
    +--ro latitude?     geographic-coordinate-degree
    +--ro longitude?    geographic-coordinate-degree
augment /nw:networks/nw:network/nw:node:
+--rw te-node-id?   te-types:te-node-id
+--rw te!
    +--rw te-node-template*

```

```

|         -> ../../../../te/templates/node-template/name
|         {template}?
+--rw te-node-attributes
|   +--rw admin-status?          te-types:te-admin-status
|   +--rw connectivity-matrices
|     +--rw number-of-entries?   uint16
|     +--rw label-restrictions
|       +--rw label-restriction* [index]
|         +--rw restriction?     enumeration
|         +--rw index           uint32
|         +--rw label-start
|           +--rw te-label
|             +--rw (technology)?
|               +--:(generic)
|                 +--rw generic?
|                   rt-types:generalized-label
|             +--rw direction?   te-label-direction
|           +--rw label-end
|             +--rw te-label
|               +--rw (technology)?
|                 +--:(generic)
|                   +--rw generic?
|                     rt-types:generalized-label
|             +--rw direction?   te-label-direction
|           +--rw label-step
|             +--rw (technology)?
|               +--:(generic)
|                 +--rw generic?   int32
|             +--rw range-bitmap? yang:hex-string
|   +--rw is-allowed?            boolean
|   +--rw underlay {te-topology-hierarchy}?
|     +--rw enabled?            boolean
|     +--rw primary-path
|       +--rw network-ref?
|         -> /nw:networks/network/network-id
|       +--rw path-element* [path-element-id]
|         +--rw path-element-id   uint32
|         +--rw (type)?
|           +--:(numbered-node-hop)
|             +--rw numbered-node-hop
|             +--rw node-id       te-node-id

```

```

| | | | | | +--rw hop-type? te-hop-type
| | | | | | +---:(numbered-link-hop)
| | | | | | | +--rw numbered-link-hop
| | | | | | | +--rw link-tp-id te-tp-id
| | | | | | | +--rw hop-type? te-hop-type
| | | | | | | +--rw direction? te-link-direction
| | | | | | +---:(unnumbered-link-hop)
| | | | | | | +--rw unnumbered-link-hop
| | | | | | | +--rw link-tp-id te-tp-id
| | | | | | | +--rw node-id te-node-id
| | | | | | | +--rw hop-type? te-hop-type
| | | | | | | +--rw direction? te-link-direction
| | | | | | +---:(as-number)
| | | | | | | +--rw as-number-hop
| | | | | | | +--rw as-number inet:as-number
| | | | | | | +--rw hop-type? te-hop-type
| | | | | | +---:(label)
| | | | | | | +--rw label-hop
| | | | | | | | +--rw te-label
| | | | | | | | | +--rw (technology)?
| | | | | | | | | | +---:(generic)
| | | | | | | | | | | +--rw generic?
| | | | | | | | | | | | rt-types:generalized-
label
| | | | | | | +--rw direction?
| | | | | | | | te-label-direction
| | | | | | +--rw backup-path* [index]
| | | | | | | +--rw index uint32
| | | | | | | +--rw network-ref?
| | | | | | | | -> /nw:networks/network/network-id
| | | | | | +--rw path-element* [path-element-id]
| | | | | | | +--rw path-element-id uint32
| | | | | | | +--rw (type)?
| | | | | | | | +---:(numbered-node-hop)
| | | | | | | | | +--rw numbered-node-hop
| | | | | | | | | +--rw node-id te-node-id
| | | | | | | | | +--rw hop-type? te-hop-type
| | | | | | | | +---:(numbered-link-hop)
| | | | | | | | | +--rw numbered-link-hop
| | | | | | | | | +--rw link-tp-id te-tp-id
| | | | | | | | | +--rw hop-type? te-hop-type

```

```

| | | | | +--rw direction? te-link-direction
| | | | | +---:(unnumbered-link-hop)
| | | | | | +--rw unnumbered-link-hop
| | | | | | +--rw link-tp-id te-tp-id
| | | | | | +--rw node-id te-node-id
| | | | | | +--rw hop-type? te-hop-type
| | | | | | +--rw direction? te-link-direction
| | | | | +---:(as-number)
| | | | | | +--rw as-number-hop
| | | | | | +--rw as-number inet:as-number
| | | | | | +--rw hop-type? te-hop-type
| | | | | +---:(label)
| | | | | | +--rw label-hop
| | | | | | | +--rw te-label
| | | | | | | | +--rw (technology)?
| | | | | | | | | +---:(generic)
| | | | | | | | | +--rw generic?
| | | | | | | | | rt-types:generalized-
label
| | | | | +--rw direction?
| | | | | | te-label-direction
| | | | +--rw protection-type? identityref
| | | | +--rw tunnel-termination-points
| | | | | +--rw source? binary
| | | | | +--rw destination? binary
| | | | +--rw tunnels
| | | | | +--rw sharing? boolean
| | | | | +--rw tunnel* [tunnel-name]
| | | | | | +--rw tunnel-name string
| | | | | | +--rw sharing? boolean
| | | +--rw path-constraints
| | | | +--rw te-bandwidth
| | | | | +--rw (technology)?
| | | | | | +---:(generic)
| | | | | | | +--rw generic? te-bandwidth
| | | | +--rw link-protection? identityref
| | | | +--rw setup-priority? uint8
| | | | +--rw hold-priority? uint8
| | | | +--rw signaling-type? identityref
| | | | +--rw path-metric-bounds
| | | | | +--rw path-metric-bound* [metric-type]

```

```

| | | | +--rw metric-type identityref
| | | | +--rw upper-bound? uint64
| | | +--rw path-affinities-values
| | | | +--rw path-affinities-value* [usage]
| | | | +--rw usage identityref
| | | | +--rw value? admin-groups
| | | +--rw path-affinity-names
| | | | +--rw path-affinity-name* [usage]
| | | | +--rw usage identityref
| | | | +--rw affinity-name* [name]
| | | | +--rw name string
| | | +--rw path-srlgs-lists
| | | | +--rw path-srlgs-list* [usage]
| | | | +--rw usage identityref
| | | | +--rw values* srlg
| | | +--rw path-srlgs-names
| | | | +--rw path-srlgs-name* [usage]
| | | | +--rw usage identityref
| | | | +--rw names* string
| | | +--rw disjointness? te-path-disjointness
| | +--rw optimizations
| | | +--rw (algorithm)?
| | | | +--:(metric) {path-optimization-metric}?
| | | | | +--rw optimization-metric* [metric-type]
| | | | | | +--rw metric-type
| | | | | | | identityref
| | | | | | +--rw weight?
| | | | | | | uint8
| | | | | | +--rw explicit-route-exclude-objects
| | | | | | | +--rw route-object-exclude-object*
| | | | | | | | [index]
| | | | | | | | +--rw index
| | | | | | | | | uint32
| | | | | | | | +--rw (type)?
| | | | | | | | | +--:(numbered-node-hop)
| | | | | | | | | | +--rw numbered-node-hop
| | | | | | | | | | | +--rw node-id te-node-id
| | | | | | | | | | | +--rw hop-type? te-hop-type
| | | | | | | | | +--:(numbered-link-hop)
| | | | | | | | | | +--rw numbered-link-hop
| | | | | | | | | | +--rw link-tp-id te-tp-id

```







```

| | | +--ro path-metric* [metric-type]
| | | | +--ro metric-type          identityref
| | | | +--ro accumulative-value? uint64
| | | +--ro path-affinities-values
| | | | +--ro path-affinities-value* [usage]
| | | |   +--ro usage          identityref
| | | |   +--ro value?        admin-groups
| | | +--ro path-affinity-names
| | | | +--ro path-affinity-name* [usage]
| | | |   +--ro usage          identityref
| | | |   +--ro affinity-name* [name]
| | | |     +--ro name          string
| | | +--ro path-srlgs-lists
| | | | +--ro path-srlgs-list* [usage]
| | | |   +--ro usage          identityref
| | | |   +--ro values*        srlg
| | | +--ro path-srlgs-names
| | | | +--ro path-srlgs-name* [usage]
| | | |   +--ro usage          identityref
| | | |   +--ro names*         string
| | | +--ro path-route-objects
| | | | +--ro path-route-object* [index]
| | | |   +--ro index                uint32
| | | |   +--ro (type)?
| | | |     +--:(numbered-node-hop)
| | | |       | +--ro numbered-node-hop
| | | |       |   +--ro node-id        te-node-id
| | | |       |   +--ro hop-type?     te-hop-type
| | | |     +--:(numbered-link-hop)
| | | |       | +--ro numbered-link-hop
| | | |       |   +--ro link-tp-id     te-tp-id
| | | |       |   +--ro hop-type?     te-hop-type
| | | |       |   +--ro direction?    te-link-direction
| | | |     +--:(unnumbered-link-hop)
| | | |       | +--ro unnumbered-link-hop
| | | |       |   +--ro link-tp-id     te-tp-id
| | | |       |   +--ro node-id        te-node-id
| | | |       |   +--ro hop-type?     te-hop-type
| | | |       |   +--ro direction?    te-link-direction
| | | |     +--:(as-number)
| | | |       | +--ro as-number-hop

```

```

| | | | +--ro as-number inet:as-number
| | | | +--ro hop-type? te-hop-type
| | | | +--:(label)
| | | |   +--ro label-hop
| | | |   +--ro te-label
| | | |     +--ro (technology)?
| | | |       | +--:(generic)
| | | |       |   +--ro generic?
| | | |       |   rt-types:generalized-
label
| | | |     +--ro direction?
| | | |       te-label-direction
| | +--rw connectivity-matrix* [id]
| |   +--rw id uint32
| |   +--rw from
| |     | +--rw tp-ref? leafref
| |     | +--rw label-restrictions
| |     |   +--rw label-restriction* [index]
| |     |     +--rw restriction? enumeration
| |     |     +--rw index uint32
| |     |     +--rw label-start
| |     |       | +--rw te-label
| |     |       |   +--rw (technology)?
| |     |       |     | +--:(generic)
| |     |       |     |   +--rw generic?
| |     |       |     |   rt-types:generalized-
label
| |     |     +--rw direction?
| |     |       te-label-direction
| |   +--rw label-end
| |     | +--rw te-label
| |     |   +--rw (technology)?
| |     |     | +--:(generic)
| |     |     |   +--rw generic?
| |     |     |   rt-types:generalized-
label
| |     |     +--rw direction?
| |     |       te-label-direction
| |   +--rw label-step
| |     | +--rw (technology)?
| |     |   +--:(generic)

```

```

| | | | +--rw generic? int32
| | | | +--rw range-bitmap? yang:hex-string
| | +--rw to
| | | +--rw tp-ref? leafref
| | | +--rw label-restrictions
| | | | +--rw label-restriction* [index]
| | | | +--rw restriction? enumeration
| | | | +--rw index uint32
| | | | +--rw label-start
| | | | | +--rw te-label
| | | | | | +--rw (technology)?
| | | | | | | +--:(generic)
| | | | | | | +--rw generic?
| | | | | | | | rt-types:generalized-
label
| | | | +--rw direction?
| | | | | te-label-direction
| | | +--rw label-end
| | | | +--rw te-label
| | | | +--rw (technology)?
| | | | | +--:(generic)
| | | | | +--rw generic?
| | | | | | rt-types:generalized-
label
| | | | +--rw direction?
| | | | | te-label-direction
| | | +--rw label-step
| | | | +--rw (technology)?
| | | | | +--:(generic)
| | | | | +--rw generic? int32
| | | | +--rw range-bitmap? yang:hex-string
| | +--rw is-allowed? boolean
| | +--rw underlay {te-topology-hierarchy}?
| | | +--rw enabled? boolean
| | | +--rw primary-path
| | | | +--rw network-ref?
| | | | | -> /nw:networks/network/network-id
| | | | +--rw path-element* [path-element-id]
| | | | | +--rw path-element-id uint32
| | | | | +--rw (type)?
| | | | | +--:(numbered-node-hop)

```

```

| | | | | +--rw numbered-node-hop
| | | | |   +--rw node-id      te-node-id
| | | | |   +--rw hop-type?   te-hop-type
| | | | | +--:(numbered-link-hop)
| | | | |   +--rw numbered-link-hop
| | | | |     +--rw link-tp-id  te-tp-id
| | | | |     +--rw hop-type?   te-hop-type
| | | | |     +--rw direction?
| | | | |         te-link-direction
| | | | | +--:(unnumbered-link-hop)
| | | | |   +--rw unnumbered-link-hop
| | | | |     +--rw link-tp-id  te-tp-id
| | | | |     +--rw node-id      te-node-id
| | | | |     +--rw hop-type?   te-hop-type
| | | | |     +--rw direction?
| | | | |         te-link-direction
| | | | | +--:(as-number)
| | | | |   +--rw as-number-hop
| | | | |     +--rw as-number    inet:as-number
| | | | |     +--rw hop-type?   te-hop-type
| | | | | +--:(label)
| | | | |   +--rw label-hop
| | | | |     +--rw te-label
| | | | |       +--rw (technology)?
| | | | |         | +--:(generic)
| | | | |         |   +--rw generic?
| | | | |         |     rt-
types:generalized-label
| | | | |           +--rw direction?
| | | | |             te-label-direction
| | | | |   +--rw backup-path* [index]
| | | | |     +--rw index          uint32
| | | | |     +--rw network-ref?
| | | | |       | -> /nw:networks/network/network-id
| | | | |   +--rw path-element* [path-element-id]
| | | | |     +--rw path-element-id      uint32
| | | | |     +--rw (type)?
| | | | |       +--:(numbered-node-hop)
| | | | |         | +--rw numbered-node-hop
| | | | |         |   +--rw node-id      te-node-id
| | | | |         |   +--rw hop-type?   te-hop-type

```

```

| | | | +--:(numbered-link-hop)
| | | | | +--rw numbered-link-hop
| | | | |   +--rw link-tp-id    te-tp-id
| | | | |   +--rw hop-type?    te-hop-type
| | | | |   +--rw direction?
| | | | |       te-link-direction
| | | | +--:(unnumbered-link-hop)
| | | | | +--rw unnumbered-link-hop
| | | | |   +--rw link-tp-id    te-tp-id
| | | | |   +--rw node-id      te-node-id
| | | | |   +--rw hop-type?    te-hop-type
| | | | |   +--rw direction?
| | | | |       te-link-direction
| | | | +--:(as-number)
| | | | | +--rw as-number-hop
| | | | |   +--rw as-number    inet:as-number
| | | | |   +--rw hop-type?    te-hop-type
| | | | +--:(label)
| | | | | +--rw label-hop
| | | | |   +--rw te-label
| | | | |     +--rw (technology)?
| | | | |       | +--:(generic)
| | | | |       |   +--rw generic?
| | | | |       |     rt-
| | | | |       |
| | | | |       +--rw direction?
| | | | |         te-label-direction
| | | | | +--rw protection-type?    identityref
| | | | | +--rw tunnel-termination-points
| | | | | | +--rw source?    binary
| | | | | | +--rw destination?  binary
| | | | | +--rw tunnels
| | | | | | +--rw sharing?    boolean
| | | | | | +--rw tunnel* [tunnel-name]
| | | | | |   +--rw tunnel-name    string
| | | | | |   +--rw sharing?      boolean
| | | | +--rw path-constraints
| | | | | +--rw te-bandwidth
| | | | | | +--rw (technology)?
| | | | | |   +--:(generic)
| | | | | |     +--rw generic?    te-bandwidth

```

types:generalized-label

```

| | | +--rw link-protection?          identityref
| | | +--rw setup-priority?          uint8
| | | +--rw hold-priority?          uint8
| | | +--rw signaling-type?         identityref
| | | +--rw path-metric-bounds
| | | | +--rw path-metric-bound* [metric-type]
| | | | | +--rw metric-type        identityref
| | | | | +--rw upper-bound?      uint64
| | | +--rw path-affinities-values
| | | | +--rw path-affinities-value* [usage]
| | | | | +--rw usage              identityref
| | | | | +--rw value?            admin-groups
| | | +--rw path-affinity-names
| | | | +--rw path-affinity-name* [usage]
| | | | | +--rw usage              identityref
| | | | | +--rw affinity-name* [name]
| | | | | | +--rw name              string
| | | +--rw path-srlgs-lists
| | | | +--rw path-srlgs-list* [usage]
| | | | | +--rw usage              identityref
| | | | | +--rw values*           srlg
| | | +--rw path-srlgs-names
| | | | +--rw path-srlgs-name* [usage]
| | | | | +--rw usage              identityref
| | | | | +--rw names*           string
| | | +--rw disjointness?
| | | | te-path-disjointness
| | +--rw optimizations
| | | +--rw (algorithm)?
| | | | +--:(metric) {path-optimization-metric}?
| | | | | +--rw optimization-metric* [metric-type]
| | | | | | +--rw metric-type
| | | | | | | identityref
| | | | | | +--rw weight?
| | | | | | | uint8
| | | | | +--rw explicit-route-exclude-objects
| | | | | | +--rw route-object-exclude-object*
| | | | | | | [index]
| | | | | | | +--rw index
| | | | | | | | uint32
| | | | | +--rw (type)?

```







```

| | | | | +-rw te-label
| | | | | +-rw (technology)?
| | | | | | +--:(generic)
| | | | | | +-rw generic?
| | | | | | | rt-
types:generalized-label
| | | | | +-rw direction?
| | | | | | te-label-
direction
| | | | | +-rw tiebreakers
| | | | | | +-rw tiebreaker* [tiebreaker-type]
| | | | | | +-rw tiebreaker-type identityref
| | | | | | +--:(objective-function)
| | | | | | {path-optimization-objective-
function}?
| | | | | | +-rw objective-function
| | | | | | +-rw objective-function-type?
| | | | | | | identityref
| | | +-ro path-properties
| | | +-ro path-metric* [metric-type]
| | | | +-ro metric-type identityref
| | | | +-ro accumulative-value? uint64
| | | +-ro path-affinities-values
| | | | +-ro path-affinities-value* [usage]
| | | | +-ro usage identityref
| | | | +-ro value? admin-groups
| | | +-ro path-affinity-names
| | | | +-ro path-affinity-name* [usage]
| | | | +-ro usage identityref
| | | | +-ro affinity-name* [name]
| | | | +-ro name string
| | | +-ro path-srlgs-lists
| | | | +-ro path-srlgs-list* [usage]
| | | | +-ro usage identityref
| | | | +-ro values* srlg
| | | +-ro path-srlgs-names
| | | | +-ro path-srlgs-name* [usage]
| | | | +-ro usage identityref
| | | | +-ro names* string
| | | +-ro path-route-objects
| | | +-ro path-route-object* [index]

```

```

| | +--ro index uint32
| | +--ro (type)?
| |   +--:(numbered-node-hop)
| |     | +--ro numbered-node-hop
| |       | +--ro node-id te-node-id
| |       | +--ro hop-type? te-hop-type
| |     +--:(numbered-link-hop)
| |       | +--ro numbered-link-hop
| |         | +--ro link-tp-id te-tp-id
| |         | +--ro hop-type? te-hop-type
| |         | +--ro direction?
| |           | te-link-direction
| |     +--:(unnumbered-link-hop)
| |       | +--ro unnumbered-link-hop
| |         | +--ro link-tp-id te-tp-id
| |         | +--ro node-id te-node-id
| |         | +--ro hop-type? te-hop-type
| |         | +--ro direction?
| |           | te-link-direction
| |     +--:(as-number)
| |       | +--ro as-number-hop
| |         | +--ro as-number inet:as-number
| |         | +--ro hop-type? te-hop-type
| |     +--:(label)
| |       +--ro label-hop
| |         +--ro te-label
| |           +--ro (technology)?
| |             | +--:(generic)
| |             | +--ro generic?
| |             | rt-
types:generalized-label
| | +--ro direction?
| |   te-label-direction
| +--rw domain-id? uint32
| +--rw is-abstract? empty
| +--rw name? string
| +--rw signaling-address* inet:ip-address
| +--rw underlay-topology {te-topology-hierarchy}?
|   +--rw network-ref? -> /nw:networks/network/network-id
+--ro oper-status? te-types:te-oper-status
+--ro geolocation

```

```

| +--ro altitude?      int64
| +--ro latitude?     geographic-coordinate-degree
| +--ro longitude?    geographic-coordinate-degree
+--ro is-multi-access-dr?      empty
+--ro information-source?      te-info-source
+--ro information-source-instance?  string
+--ro information-source-state
| +--ro credibility-preference?  uint16
| +--ro logical-network-element? string
| +--ro network-instance?       string
| +--ro topology
|   +--ro node-ref?      leafref
|   +--ro network-ref?   -> /nw:networks/network/network-id
+--ro information-source-entry*
|   [information-source information-source-instance]
|   +--ro information-source      te-info-source
|   +--ro information-source-instance  string
|   +--ro information-source-state
|   | +--ro credibility-preference?  uint16
|   | +--ro logical-network-element? string
|   | +--ro network-instance?       string
|   | +--ro topology
|   |   +--ro node-ref?      leafref
|   |   +--ro network-ref?
|   |     -> /nw:networks/network/network-id
|   +--ro connectivity-matrices
|   | +--ro number-of-entries?  uint16
|   | +--ro label-restrictions
|   | | +--ro label-restriction* [index]
|   | |   +--ro restriction?  enumeration
|   | |   +--ro index        uint32
|   | |   +--ro label-start
|   | |     +--ro te-label
|   | |       +--ro (technology)?
|   | |         +--:(generic)
|   | |           +--ro generic?
|   | |             rt-types:generalized-label
|   | |           +--ro direction?      te-label-direction
|   | |     +--ro label-end
|   | |       +--ro te-label
|   | |         +--ro (technology)?

```

```

| | | | | +--:(generic)
| | | | |   +--ro generic?
| | | | |     rt-types:generalized-label
| | | | |   +--ro direction?       te-label-direction
| | | | | +--ro label-step
| | | | | | +--ro (technology)?
| | | | | |   +--:(generic)
| | | | | |     +--ro generic?   int32
| | | | | |   +--ro range-bitmap? yang:hex-string
| | | | | +--ro is-allowed?         boolean
| | | | | +--ro underlay {te-topology-hierarchy}?
| | | | | | +--ro enabled?           boolean
| | | | | | +--ro primary-path
| | | | | | | +--ro network-ref?
| | | | | | |   -> /nw:networks/network/network-id
| | | | | | +--ro path-element* [path-element-id]
| | | | | |   +--ro path-element-id       uint32
| | | | | |   +--ro (type)?
| | | | | |     +--:(numbered-node-hop)
| | | | | | |   +--ro numbered-node-hop
| | | | | | |     +--ro node-id       te-node-id
| | | | | | |     +--ro hop-type?    te-hop-type
| | | | | | +--:(numbered-link-hop)
| | | | | | |   +--ro numbered-link-hop
| | | | | | |     +--ro link-tp-id    te-tp-id
| | | | | | |     +--ro hop-type?    te-hop-type
| | | | | | |     +--ro direction?  te-link-direction
| | | | | | +--:(unnumbered-link-hop)
| | | | | | |   +--ro unnumbered-link-hop
| | | | | | |     +--ro link-tp-id    te-tp-id
| | | | | | |     +--ro node-id       te-node-id
| | | | | | |     +--ro hop-type?    te-hop-type
| | | | | | |     +--ro direction?  te-link-direction
| | | | | +--:(as-number)
| | | | | |   +--ro as-number-hop
| | | | | | |   +--ro as-number      inet:as-number
| | | | | | |   +--ro hop-type?    te-hop-type
| | | | | +--:(label)
| | | | | |   +--ro label-hop
| | | | | | |   +--ro te-label
| | | | | | |   +--ro (technology)?

```

```

| | | | | +---:(generic)
| | | | | | +---ro generic?
| | | | | | rt-types:generalized-
label
| | | | | +---ro direction?
| | | | | | te-label-direction
| | | | +---ro backup-path* [index]
| | | | | +---ro index uint32
| | | | | +---ro network-ref?
| | | | | | -> /nw:networks/network/network-id
| | | | | +---ro path-element* [path-element-id]
| | | | | | +---ro path-element-id uint32
| | | | | | +---ro (type)?
| | | | | | +---:(numbered-node-hop)
| | | | | | | +---ro numbered-node-hop
| | | | | | | +---ro node-id te-node-id
| | | | | | | +---ro hop-type? te-hop-type
| | | | | | +---:(numbered-link-hop)
| | | | | | | +---ro numbered-link-hop
| | | | | | | +---ro link-tp-id te-tp-id
| | | | | | | +---ro hop-type? te-hop-type
| | | | | | | +---ro direction? te-link-direction
| | | | | | +---:(unnumbered-link-hop)
| | | | | | | +---ro unnumbered-link-hop
| | | | | | | +---ro link-tp-id te-tp-id
| | | | | | | +---ro node-id te-node-id
| | | | | | | +---ro hop-type? te-hop-type
| | | | | | | +---ro direction? te-link-direction
| | | | | | +---:(as-number)
| | | | | | | +---ro as-number-hop
| | | | | | | +---ro as-number inet:as-number
| | | | | | | +---ro hop-type? te-hop-type
| | | | | | +---:(label)
| | | | | | | +---ro label-hop
| | | | | | | +---ro te-label
| | | | | | | +---ro (technology)?
| | | | | | | | +---:(generic)
| | | | | | | | +---ro generic?
| | | | | | | | rt-types:generalized-
label
| | | | | | +---ro direction?

```

```

| | | | te-label-direction
| | | +--ro protection-type?          identityref
| | | +--ro tunnel-termination-points
| | | | +--ro source?                binary
| | | | +--ro destination?          binary
| | | +--ro tunnels
| | |   +--ro sharing?              boolean
| | |   +--ro tunnel* [tunnel-name]
| | |     +--ro tunnel-name         string
| | |     +--ro sharing?            boolean
| | +--ro path-constraints
| | | +--ro te-bandwidth
| | | | +--ro (technology)?
| | | |   +--:(generic)
| | | |     +--ro generic?          te-bandwidth
| | | +--ro link-protection?        identityref
| | | +--ro setup-priority?         uint8
| | | +--ro hold-priority?          uint8
| | | +--ro signaling-type?         identityref
| | | +--ro path-metric-bounds
| | | | +--ro path-metric-bound* [metric-type]
| | | |   +--ro metric-type         identityref
| | | |   +--ro upper-bound?        uint64
| | | +--ro path-affinities-values
| | | | +--ro path-affinities-value* [usage]
| | | |   +--ro usage                identityref
| | | |   +--ro value?              admin-groups
| | | +--ro path-affinity-names
| | | | +--ro path-affinity-name* [usage]
| | | |   +--ro usage                identityref
| | | |   +--ro affinity-name* [name]
| | | |     +--ro name                string
| | | +--ro path-srlgs-lists
| | | | +--ro path-srlgs-list* [usage]
| | | |   +--ro usage                identityref
| | | |   +--ro values*             srlg
| | | +--ro path-srlgs-names
| | | | +--ro path-srlgs-name* [usage]
| | | |   +--ro usage                identityref
| | | |   +--ro names*              string
| | | +--ro disjointness?          te-path-disjointness

```



```

| | +--ro optimizations
| | | +--ro (algorithm)?
| | |   +--:(metric) {path-optimization-metric}?
| | |     +--ro optimization-metric* [metric-type]
| | |       +--ro metric-type
| | |         | identityref
| | |         +--ro weight?
| | |           | uint8
| | |         +--ro explicit-route-exclude-objects
| | |           +--ro route-object-exclude-object*
| | |             [index]
| | |             +--ro index
| | |               | uint32
| | |             +--ro (type)?
| | |               +--:(numbered-node-hop)
| | |                 | +--ro numbered-node-hop
| | |                   | +--ro node-id      te-node-id
| | |                   | +--ro hop-type?   te-hop-type
| | |               +--:(numbered-link-hop)
| | |                 | +--ro numbered-link-hop
| | |                   | +--ro link-tp-id   te-tp-id
| | |                   | +--ro hop-type?
| | |                     | te-hop-type
| | |                   +--ro direction?
| | |                     | te-link-direction
| | |               +--:(unnumbered-link-hop)
| | |                 | +--ro unnumbered-link-hop
| | |                   | +--ro link-tp-id   te-tp-id
| | |                   | +--ro node-id
| | |                     | te-node-id
| | |                   +--ro hop-type?
| | |                     | te-hop-type
| | |                   +--ro direction?
| | |                     | te-link-direction
| | |               +--:(as-number)
| | |                 | +--ro as-number-hop
| | |                   | +--ro as-number
| | |                     | inet:as-number
| | |                   +--ro hop-type?
| | |                     | te-hop-type
| | |               +--:(label)

```







```

| | | | +--ro label-start
| | | | | +--ro te-label
| | | | | +--ro (technology)?
| | | | | | +--:(generic)
| | | | | | +--ro generic?
| | | | | | | rt-types:generalized-
label
| | | | | +--ro direction?
| | | | | | te-label-direction
| | | | | +--ro label-end
| | | | | | +--ro te-label
| | | | | | +--ro (technology)?
| | | | | | | +--:(generic)
| | | | | | | +--ro generic?
| | | | | | | | rt-types:generalized-
label
| | | | | +--ro direction?
| | | | | | te-label-direction
| | | | | +--ro label-step
| | | | | | +--ro (technology)?
| | | | | | | +--:(generic)
| | | | | | | +--ro generic? int32
| | | | | | +--ro range-bitmap? yang:hex-string
| | | | +--ro to
| | | | | +--ro tp-ref? leafref
| | | | | +--ro label-restrictions
| | | | | | +--ro label-restriction* [index]
| | | | | | +--ro restriction? enumeration
| | | | | | +--ro index uint32
| | | | | +--ro label-start
| | | | | | +--ro te-label
| | | | | | +--ro (technology)?
| | | | | | | +--:(generic)
| | | | | | | +--ro generic?
| | | | | | | | rt-types:generalized-
label
| | | | | +--ro direction?
| | | | | | te-label-direction
| | | | | +--ro label-end
| | | | | | +--ro te-label
| | | | | | +--ro (technology)?

```

```

| | | | | +---:(generic)
| | | | |   +---ro generic?
| | | | |     rt-types:generalized-
label
| | | | |   +---ro direction?
| | | | |     te-label-direction
| | | | |   +---ro label-step
| | | | |   +---ro (technology)?
| | | | |   +---:(generic)
| | | | |     +---ro generic?   int32
| | | | |     +---ro range-bitmap? yang:hex-string
| | | | | +---ro is-allowed?       boolean
| | | | | +---ro underlay {te-topology-hierarchy}?
| | | | | | +---ro enabled?           boolean
| | | | | | +---ro primary-path
| | | | | | | +---ro network-ref?
| | | | | | | | -> /nw:networks/network/network-id
| | | | | | | +---ro path-element* [path-element-id]
| | | | | | | +---ro path-element-id       uint32
| | | | | | | +---ro (type)?
| | | | | | |   +---:(numbered-node-hop)
| | | | | | | | +---ro numbered-node-hop
| | | | | | | |   +---ro node-id       te-node-id
| | | | | | | |   +---ro hop-type?    te-hop-type
| | | | | | | +---:(numbered-link-hop)
| | | | | | | | +---ro numbered-link-hop
| | | | | | | |   +---ro link-tp-id    te-tp-id
| | | | | | | |   +---ro hop-type?    te-hop-type
| | | | | | | |   +---ro direction?
| | | | | | | |     te-link-direction
| | | | | | | +---:(unnumbered-link-hop)
| | | | | | | | +---ro unnumbered-link-hop
| | | | | | | |   +---ro link-tp-id    te-tp-id
| | | | | | | |   +---ro node-id       te-node-id
| | | | | | | |   +---ro hop-type?    te-hop-type
| | | | | | | |   +---ro direction?
| | | | | | | |     te-link-direction
| | | | | | | +---:(as-number)
| | | | | | | | +---ro as-number-hop
| | | | | | | |   +---ro as-number    inet:as-number
| | | | | | | |   +---ro hop-type?    te-hop-type

```

```

| | | | +--:(label)
| | | |   +--ro label-hop
| | | |     +--ro te-label
| | | |       +--ro (technology)?
| | | |         | +--:(generic)
| | | |         |   +--ro generic?
| | | |         |     rt-
types:generalized-label
| | | |           +--ro direction?
| | | |             te-label-direction
| | | |   +--ro backup-path* [index]
| | | |     +--ro index          uint32
| | | |     +--ro network-ref?
| | | |       | -> /nw:networks/network/network-id
| | | |     +--ro path-element* [path-element-id]
| | | |       +--ro path-element-id          uint32
| | | |       +--ro (type)?
| | | |         +--:(numbered-node-hop)
| | | |           | +--ro numbered-node-hop
| | | |             | +--ro node-id          te-node-id
| | | |             | +--ro hop-type?       te-hop-type
| | | |         +--:(numbered-link-hop)
| | | |           | +--ro numbered-link-hop
| | | |             | +--ro link-tp-id       te-tp-id
| | | |             | +--ro hop-type?       te-hop-type
| | | |             | +--ro direction?
| | | |             |   te-link-direction
| | | |         +--:(unnumbered-link-hop)
| | | |           | +--ro unnumbered-link-hop
| | | |             | +--ro link-tp-id       te-tp-id
| | | |             | +--ro node-id          te-node-id
| | | |             | +--ro hop-type?       te-hop-type
| | | |             | +--ro direction?
| | | |             |   te-link-direction
| | | |         +--:(as-number)
| | | |           | +--ro as-number-hop
| | | |             | +--ro as-number          inet:as-number
| | | |             | +--ro hop-type?       te-hop-type
| | | |         +--:(label)
| | | |           +--ro label-hop
| | | |           +--ro te-label

```

```

| | | | +--ro (technology)?
| | | | | +--:(generic)
| | | | | +--ro generic?
| | | | | rt-
types:generalized-label
| | | | +--ro direction?
| | | | | te-label-direction
| | | | +--ro protection-type? identityref
| | | | +--ro tunnel-termination-points
| | | | | +--ro source? binary
| | | | | +--ro destination? binary
| | | | +--ro tunnels
| | | | | +--ro sharing? boolean
| | | | | +--ro tunnel* [tunnel-name]
| | | | | +--ro tunnel-name string
| | | | | +--ro sharing? boolean
| | | +--ro path-constraints
| | | | +--ro te-bandwidth
| | | | | +--ro (technology)?
| | | | | +--:(generic)
| | | | | +--ro generic? te-bandwidth
| | | | +--ro link-protection? identityref
| | | | +--ro setup-priority? uint8
| | | | +--ro hold-priority? uint8
| | | | +--ro signaling-type? identityref
| | | | +--ro path-metric-bounds
| | | | | +--ro path-metric-bound* [metric-type]
| | | | | +--ro metric-type identityref
| | | | | +--ro upper-bound? uint64
| | | | +--ro path-affinities-values
| | | | | +--ro path-affinities-value* [usage]
| | | | | +--ro usage identityref
| | | | | +--ro value? admin-groups
| | | | +--ro path-affinity-names
| | | | | +--ro path-affinity-name* [usage]
| | | | | +--ro usage identityref
| | | | | +--ro affinity-name* [name]
| | | | | +--ro name string
| | | | +--ro path-srlgs-lists
| | | | | +--ro path-srlgs-list* [usage]
| | | | | +--ro usage identityref

```



```

| | | | +--ro values* srlg
| | | | +--ro path-srlgs-names
| | | | | +--ro path-srlgs-name* [usage]
| | | | | +--ro usage identityref
| | | | | +--ro names* string
| | | | +--ro disjointness?
| | | | | te-path-disjointness
| | +--ro optimizations
| | | +--ro (algorithm)?
| | | | +--:(metric) {path-optimization-metric}?
| | | | | +--ro optimization-metric* [metric-type]
| | | | | | +--ro metric-type
| | | | | | | identityref
| | | | | | +--ro weight?
| | | | | | | uint8
| | | | | | +--ro explicit-route-exclude-objects
| | | | | | | +--ro route-object-exclude-object*
| | | | | | | | [index]
| | | | | | | +--ro index
| | | | | | | | uint32
| | | | | | +--ro (type)?
| | | | | | | +--:(numbered-node-hop)
| | | | | | | | +--ro numbered-node-hop
| | | | | | | | | +--ro node-id
| | | | | | | | | | te-node-id
| | | | | | | | | +--ro hop-type?
| | | | | | | | | | te-hop-type
| | | | | | | +--:(numbered-link-hop)
| | | | | | | | +--ro numbered-link-hop
| | | | | | | | | +--ro link-tp-id
| | | | | | | | | | te-tp-id
| | | | | | | | | +--ro hop-type?
| | | | | | | | | | te-hop-type
| | | | | | | | | +--ro direction?
| | | | | | | | | | te-link-direction
| | | | | | | +--:(unnumbered-link-hop)
| | | | | | | | +--ro unnumbered-link-hop
| | | | | | | | | +--ro link-tp-id
| | | | | | | | | | te-tp-id
| | | | | | | | | +--ro node-id
| | | | | | | | | | te-node-id

```





```

| | | +--ro metric-type          identityref
| | | +--ro accumulative-value? uint64
| | | +--ro path-affinities-values
| | | | +--ro path-affinities-value* [usage]
| | | |   +--ro usage          identityref
| | | |   +--ro value?        admin-groups
| | | +--ro path-affinity-names
| | | | +--ro path-affinity-name* [usage]
| | | |   +--ro usage          identityref
| | | |   +--ro affinity-name* [name]
| | | |     +--ro name         string
| | | +--ro path-srlgs-lists
| | | | +--ro path-srlgs-list* [usage]
| | | |   +--ro usage          identityref
| | | |   +--ro values*       srlg
| | | +--ro path-srlgs-names
| | | | +--ro path-srlgs-name* [usage]
| | | |   +--ro usage          identityref
| | | |   +--ro names*       string
| | | +--ro path-route-objects
| | | | +--ro path-route-object* [index]
| | | |   +--ro index          uint32
| | | |   +--ro (type)?
| | | |     +--:(numbered-node-hop)
| | | | |   +--ro numbered-node-hop
| | | | |     +--ro node-id      te-node-id
| | | | |     +--ro hop-type?   te-hop-type
| | | | |   +--:(numbered-link-hop)
| | | | | |   +--ro numbered-link-hop
| | | | | |     +--ro link-tp-id  te-tp-id
| | | | | |     +--ro hop-type?   te-hop-type
| | | | | |     +--ro direction?
| | | | | |       te-link-direction
| | | | |   +--:(unnumbered-link-hop)
| | | | | |   +--ro unnumbered-link-hop
| | | | | |     +--ro link-tp-id  te-tp-id
| | | | | |     +--ro node-id      te-node-id
| | | | | |     +--ro hop-type?   te-hop-type
| | | | | |     +--ro direction?
| | | | | |       te-link-direction
| | | | +--:(as-number)

```

```

| | | | +--ro as-number-hop
| | | |   +--ro as-number    inet:as-number
| | | |   +--ro hop-type?   te-hop-type
| | | |   +--:(label)
| | | |     +--ro label-hop
| | | |       +--ro te-label
| | | |         +--ro (technology)?
| | | |           | +--:(generic)
| | | |           |   +--ro generic?
| | | |           |     rt-
types:generalized-label
| | | |     +--ro direction?
| | | |       | te-label-direction
| | | |   +--ro domain-id?      uint32
| | | |   +--ro is-abstract?   empty
| | | |   +--ro name?         string
| | | |   +--ro signaling-address*  inet:ip-address
| | | |   +--ro underlay-topology {te-topology-hierarchy}?
| | | |     +--ro network-ref?  -> /nw:networks/network/network-id
+--ro statistics
| | | |   +--ro discontinuity-time?  yang:date-and-time
| | | |   +--ro node
| | | |     | +--ro disables?      yang:counter32
| | | |     | +--ro enables?     yang:counter32
| | | |     | +--ro maintenance-sets?  yang:counter32
| | | |     | +--ro maintenance-clears? yang:counter32
| | | |     | +--ro modifies?     yang:counter32
| | | |   +--ro connectivity-matrix-entry
| | | |     +--ro creates?   yang:counter32
| | | |     +--ro deletes?  yang:counter32
| | | |     +--ro disables? yang:counter32
| | | |     +--ro enables?  yang:counter32
| | | |     +--ro modifies? yang:counter32
+--rw tunnel-termination-point* [tunnel-tp-id]
  +--rw tunnel-tp-id          binary
  +--rw admin-status?
  |   te-types:te-admin-status
  +--rw name?                 string
  +--rw switching-capability? identityref
  +--rw encoding?            identityref
  +--rw inter-layer-lock-id* uint32

```

```

+--rw protection-type?                identityref
+--rw client-layer-adaptation
| +--rw switching-capability*
|   [switching-capability encoding]
|   +--rw switching-capability        identityref
|   +--rw encoding                    identityref
|   +--rw te-bandwidth
|     +--rw (technology)?
|       +--:(generic)
|         +--rw generic?              te-bandwidth
+--rw local-link-connectivities
| +--rw number-of-entries?             uint16
| +--rw label-restrictions
| | +--rw label-restriction* [index]
| |   +--rw restriction?              enumeration
| |   +--rw index                    uint32
| |   +--rw label-start
| |     | +--rw te-label
| |     |   +--rw (technology)?
| |     |   | +--:(generic)
| |     |   |   +--rw generic?
| |     |   |   | rt-types:generalized-label
| |     |   |   +--rw direction?      te-label-direction
| |     |   +--rw label-end
| |     |     +--rw te-label
| |     |     | +--rw (technology)?
| |     |     | | +--:(generic)
| |     |     | |   +--rw generic?
| |     |     | |   | rt-types:generalized-label
| |     |     | |   +--rw direction?  te-label-direction
| |     |   +--rw label-step
| |     |     +--rw (technology)?
| |     |     | +--:(generic)
| |     |     |   +--rw generic?      int32
| |     |   +--rw range-bitmap?      yang:hex-string
| +--rw is-allowed?                  boolean
| +--rw underlay {te-topology-hierarchy}?
| | +--rw enabled?                    boolean
| | +--rw primary-path
| | | +--rw network-ref?
| | | | -> /nw:networks/network/network-id

```

```

| | | +--rw path-element* [path-element-id]
| | |   +--rw path-element-id          uint32
| | |   +--rw (type)?
| | |     +--:(numbered-node-hop)
| | |       | +--rw numbered-node-hop
| | |         | +--rw node-id      te-node-id
| | |         | +--rw hop-type?   te-hop-type
| | |     +--:(numbered-link-hop)
| | |       | +--rw numbered-link-hop
| | |         | +--rw link-tp-id   te-tp-id
| | |         | +--rw hop-type?   te-hop-type
| | |         | +--rw direction?  te-link-direction
| | |     +--:(unnumbered-link-hop)
| | |       | +--rw unnumbered-link-hop
| | |         | +--rw link-tp-id   te-tp-id
| | |         | +--rw node-id     te-node-id
| | |         | +--rw hop-type?   te-hop-type
| | |         | +--rw direction?  te-link-direction
| | |     +--:(as-number)
| | |       | +--rw as-number-hop
| | |         | +--rw as-number   inet:as-number
| | |         | +--rw hop-type?   te-hop-type
| | |     +--:(label)
| | |       +--rw label-hop
| | |         +--rw te-label
| | |           +--rw (technology)?
| | |             | +--:(generic)
| | |             |   +--rw generic?
| | |             |     rt-types:generalized-
label          | +--rw direction?
| | |           |     te-label-direction
| | | +--rw backup-path* [index]
| | |   +--rw index          uint32
| | |   +--rw network-ref?
| | |     |   -> /nw:networks/network/network-id
| | |   +--rw path-element* [path-element-id]
| | |     +--rw path-element-id          uint32
| | |     +--rw (type)?
| | |       +--:(numbered-node-hop)
| | |         | +--rw numbered-node-hop

```

```

| | | | +--rw node-id      te-node-id
| | | | +--rw hop-type?   te-hop-type
| | | | +---:(numbered-link-hop)
| | | | | +--rw numbered-link-hop
| | | | | +--rw link-tp-id   te-tp-id
| | | | | +--rw hop-type?   te-hop-type
| | | | | +--rw direction?  te-link-direction
| | | | +---:(unnumbered-link-hop)
| | | | | +--rw unnumbered-link-hop
| | | | | +--rw link-tp-id   te-tp-id
| | | | | +--rw node-id      te-node-id
| | | | | +--rw hop-type?   te-hop-type
| | | | | +--rw direction?  te-link-direction
| | | | +---:(as-number)
| | | | | +--rw as-number-hop
| | | | | +--rw as-number    inet:as-number
| | | | | +--rw hop-type?   te-hop-type
| | | | +---:(label)
| | | | | +--rw label-hop
| | | | | +--rw te-label
| | | | | +--rw (technology)?
| | | | | | +---:(generic)
| | | | | | +--rw generic?
| | | | | | rt-types:generalized-
label
| | | | +--rw direction?
| | | | | te-label-direction
| | +--rw protection-type?      identityref
| | +--rw tunnel-termination-points
| | | +--rw source?             binary
| | | +--rw destination?       binary
| | +--rw tunnels
| | | +--rw sharing?           boolean
| | | +--rw tunnel* [tunnel-name]
| | | | +--rw tunnel-name      string
| | | | +--rw sharing?         boolean
| +--rw path-constraints
| | +--rw te-bandwidth
| | | +--rw (technology)?
| | | | +---:(generic)
| | | | +--rw generic?        te-bandwidth

```



```

| | +--rw link-protection?          identityref
| | +--rw setup-priority?          uint8
| | +--rw hold-priority?          uint8
| | +--rw signaling-type?         identityref
| | +--rw path-metric-bounds
| | | +--rw path-metric-bound* [metric-type]
| | | | +--rw metric-type        identityref
| | | | +--rw upper-bound?      uint64
| | +--rw path-affinities-values
| | | +--rw path-affinities-value* [usage]
| | | | +--rw usage              identityref
| | | | +--rw value?            admin-groups
| | +--rw path-affinity-names
| | | +--rw path-affinity-name* [usage]
| | | | +--rw usage              identityref
| | | | +--rw affinity-name* [name]
| | | | | +--rw name             string
| | +--rw path-srlgs-lists
| | | +--rw path-srlgs-list* [usage]
| | | | +--rw usage              identityref
| | | | +--rw values*          srlg
| | +--rw path-srlgs-names
| | | +--rw path-srlgs-name* [usage]
| | | | +--rw usage              identityref
| | | | +--rw names*          string
| | +--rw disjointness?          te-path-disjointness
+--rw optimizations
| | +--rw (algorithm)?
| | | +--:(metric) {path-optimization-metric}?
| | | | +--rw optimization-metric* [metric-type]
| | | | | +--rw metric-type
| | | | | | identityref
| | | | | +--rw weight?
| | | | | | uint8
| | | | | +--rw explicit-route-exclude-objects
| | | | | | +--rw route-object-exclude-object*
| | | | | | | [index]
| | | | | | | +--rw index
| | | | | | | | uint32
| | | | | | | +--rw (type)?
| | | | | | | +--:(numbered-node-hop)

```

```

| | | | | | +--rw numbered-node-hop
| | | | | | |   +--rw node-id       te-node-id
| | | | | | |   +--rw hop-type?    te-hop-type
| | | | | | +---:(numbered-link-hop)
| | | | | | |   +--rw numbered-link-hop
| | | | | | |   +--rw link-tp-id    te-tp-id
| | | | | | |   +--rw hop-type?
| | | | | | |   |       te-hop-type
| | | | | | |   +--rw direction?
| | | | | | |   |       te-link-direction
| | | | | | +---:(unnumbered-link-hop)
| | | | | | |   +--rw unnumbered-link-hop
| | | | | | |   +--rw link-tp-id    te-tp-id
| | | | | | |   +--rw node-id
| | | | | | |   |       te-node-id
| | | | | | |   +--rw hop-type?
| | | | | | |   |       te-hop-type
| | | | | | |   +--rw direction?
| | | | | | |   |       te-link-direction
| | | | | | +---:(as-number)
| | | | | | |   +--rw as-number-hop
| | | | | | |   +--rw as-number
| | | | | | |   |       inet:as-number
| | | | | | |   +--rw hop-type?
| | | | | | |   |       te-hop-type
| | | | | | +---:(label)
| | | | | | |   +--rw label-hop
| | | | | | |   +--rw te-label
| | | | | | |   +--rw (technology)?
| | | | | | |   |   +---:(generic)
| | | | | | |   |   |   +--rw generic?
| | | | | | |   |   |   |       rt-
types:generalized-label
| | | | | | |   +--rw direction?
| | | | | | |   |       te-label-direction
| | | | | | +---:(srlg)
| | | | | | |   +--rw srlg
| | | | | | |   +--rw srlg?    uint32
| | | | | | +--rw explicit-route-include-objects
| | | | | | +--rw route-object-include-object*
| | | | | | [index]

```

```

| | | | +--rw index
| | | | |   uint32
| | | | +--rw (type)?
| | | |   +--:(numbered-node-hop)
| | | |   | +--rw numbered-node-hop
| | | |   |   +--rw node-id   te-node-id
| | | |   |   +--rw hop-type? te-hop-type
| | | |   +--:(numbered-link-hop)
| | | |   | +--rw numbered-link-hop
| | | |   |   +--rw link-tp-id   te-tp-id
| | | |   |   +--rw hop-type?
| | | |   |   |   te-hop-type
| | | |   |   +--rw direction?
| | | |   |   |   te-link-direction
| | | |   +--:(unnumbered-link-hop)
| | | |   | +--rw unnumbered-link-hop
| | | |   |   +--rw link-tp-id   te-tp-id
| | | |   |   +--rw node-id
| | | |   |   |   te-node-id
| | | |   |   +--rw hop-type?
| | | |   |   |   te-hop-type
| | | |   |   +--rw direction?
| | | |   |   |   te-link-direction
| | | |   +--:(as-number)
| | | |   | +--rw as-number-hop
| | | |   |   +--rw as-number
| | | |   |   |   inet:as-number
| | | |   |   +--rw hop-type?
| | | |   |   |   te-hop-type
| | | |   +--:(label)
| | | |   | +--rw label-hop
| | | |   |   +--rw te-label
| | | |   |   +--rw (technology)?
| | | |   |   |   +--:(generic)
| | | |   |   |   |   +--rw generic?
| | | |   |   |   |   rt-
| | | |   |   |   |   +--rw direction?
| | | |   |   |   |   |   te-label-direction
| | | |   |   +--rw tiebreakers
| | | |   |   +--rw tiebreaker* [tiebreaker-type]

```

```

| | | +-rw tiebreaker-type identityref
| | +--:(objective-function)
| | | {path-optimization-objective-function}?
| | +-rw objective-function
| | +-rw objective-function-type? identityref
| +--ro path-properties
| | +--ro path-metric* [metric-type]
| | | +-ro metric-type identityref
| | | +-ro accumulative-value? uint64
| | +--ro path-affinities-values
| | | +-ro path-affinities-value* [usage]
| | | +-ro usage identityref
| | | +-ro value? admin-groups
| | +--ro path-affinity-names
| | | +-ro path-affinity-name* [usage]
| | | +-ro usage identityref
| | | +-ro affinity-name* [name]
| | | +-ro name string
| | +--ro path-srlgs-lists
| | | +-ro path-srlgs-list* [usage]
| | | +-ro usage identityref
| | | +-ro values* srlg
| | +--ro path-srlgs-names
| | | +-ro path-srlgs-name* [usage]
| | | +-ro usage identityref
| | | +-ro names* string
| | +--ro path-route-objects
| | +-ro path-route-object* [index]
| | +-ro index uint32
| | +-ro (type)?
| | | +--:(numbered-node-hop)
| | | | +-ro numbered-node-hop
| | | | +-ro node-id te-node-id
| | | | +-ro hop-type? te-hop-type
| | | +--:(numbered-link-hop)
| | | | +-ro numbered-link-hop
| | | | +-ro link-tp-id te-tp-id
| | | | +-ro hop-type? te-hop-type
| | | | +-ro direction? te-link-direction
| | | +--:(unnumbered-link-hop)
| | | | +-ro unnumbered-link-hop

```

```

| | | | +--ro link-tp-id      te-tp-id
| | | | +--ro node-id       te-node-id
| | | | +--ro hop-type?     te-hop-type
| | | | +--ro direction?    te-link-direction
| | | | +--:(as-number)
| | | | | +--ro as-number-hop
| | | | | +--ro as-number    inet:as-number
| | | | | +--ro hop-type?    te-hop-type
| | | | +--:(label)
| | | | | +--ro label-hop
| | | | | +--ro te-label
| | | | | | +--ro (technology)?
| | | | | | | +--:(generic)
| | | | | | | +--ro generic?
| | | | | | | | rt-types:generalized-
label
| | | | | | | | +--ro direction?
| | | | | | | | | te-label-direction
| | | | +--rw local-link-connectivity* [link-tp-ref]
| | | | | +--rw link-tp-ref
| | | | | | -> ../../../../../../nt:termination-point/tp-id
| | | | +--rw label-restrictions
| | | | | +--rw label-restriction* [index]
| | | | | | +--rw restriction?  enumeration
| | | | | | +--rw index        uint32
| | | | | | +--rw label-start
| | | | | | | +--rw te-label
| | | | | | | | +--rw (technology)?
| | | | | | | | | +--:(generic)
| | | | | | | | | +--rw generic?
| | | | | | | | | | rt-types:generalized-label
| | | | | | | | | +--rw direction?    te-label-direction
| | | | | +--rw label-end
| | | | | | +--rw te-label
| | | | | | | +--rw (technology)?
| | | | | | | | +--:(generic)
| | | | | | | | +--rw generic?
| | | | | | | | | rt-types:generalized-label
| | | | | | | | | +--rw direction?    te-label-direction
| | | | +--rw label-step
| | | | | +--rw (technology)?

```

```

|   |   |   +---:(generic)
|   |   |       +---rw generic?   int32
|   |   |       +---rw range-bitmap? yang:hex-string
|   +---rw is-allowed?           boolean
|   +---rw underlay {te-topology-hierarchy}?
|   |   +---rw enabled?           boolean
|   |   +---rw primary-path
|   |   |   +---rw network-ref?
|   |   |   |       -> /nw:networks/network/network-id
|   |   |   +---rw path-element* [path-element-id]
|   |   |       +---rw path-element-id           uint32
|   |   |       +---rw (type)?
|   |   |       +---:(numbered-node-hop)
|   |   |       |   +---rw numbered-node-hop
|   |   |       |       +---rw node-id         te-node-id
|   |   |       |       +---rw hop-type?      te-hop-type
|   |   |       +---:(numbered-link-hop)
|   |   |       |   +---rw numbered-link-hop
|   |   |       |       +---rw link-tp-id     te-tp-id
|   |   |       |       +---rw hop-type?      te-hop-type
|   |   |       |       +---rw direction?
|   |   |       |           te-link-direction
|   |   |       +---:(unnumbered-link-hop)
|   |   |       |   +---rw unnumbered-link-hop
|   |   |       |       +---rw link-tp-id     te-tp-id
|   |   |       |       +---rw node-id         te-node-id
|   |   |       |       +---rw hop-type?      te-hop-type
|   |   |       |       +---rw direction?
|   |   |       |           te-link-direction
|   |   |       +---:(as-number)
|   |   |       |   +---rw as-number-hop
|   |   |       |       +---rw as-number     inet:as-number
|   |   |       |       +---rw hop-type?     te-hop-type
|   |   |       +---:(label)
|   |   |       |   +---rw label-hop
|   |   |       |       +---rw te-label
|   |   |       |           +---rw (technology)?
|   |   |       |           |   +---:(generic)
|   |   |       |           |       +---rw generic?
|   |   |       |           |           rt-
types:generalized-label

```



```

|   | +--rw tunnel-termination-points
|   | | +--rw source?      binary
|   | | +--rw destination?  binary
|   | +--rw tunnels
|   | | +--rw sharing?    boolean
|   | | +--rw tunnel* [tunnel-name]
|   | |   +--rw tunnel-name  string
|   | |   +--rw sharing?    boolean
+--rw path-constraints
|   +--rw te-bandwidth
|   | +--rw (technology)?
|   | | +--:(generic)
|   | |   +--rw generic?    te-bandwidth
|   +--rw link-protection?    identityref
|   +--rw setup-priority?     uint8
|   +--rw hold-priority?      uint8
|   +--rw signaling-type?     identityref
|   +--rw path-metric-bounds
|   | +--rw path-metric-bound* [metric-type]
|   | | +--rw metric-type    identityref
|   | | +--rw upper-bound?   uint64
|   +--rw path-affinities-values
|   | +--rw path-affinities-value* [usage]
|   | | +--rw usage          identityref
|   | | +--rw value?        admin-groups
|   +--rw path-affinity-names
|   | +--rw path-affinity-name* [usage]
|   | | +--rw usage          identityref
|   | | +--rw affinity-name* [name]
|   | |   +--rw name        string
|   +--rw path-srlgs-lists
|   | +--rw path-srlgs-list* [usage]
|   | | +--rw usage          identityref
|   | | +--rw values*       srlg
|   +--rw path-srlgs-names
|   | +--rw path-srlgs-name* [usage]
|   | | +--rw usage          identityref
|   | | +--rw names*        string
|   +--rw disjointness?
|   |   te-path-disjointness
+--rw optimizations

```



```

|   | +--rw (algorithm)?
|   |   +--:(metric) {path-optimization-metric}?
|   |     +--rw optimization-metric* [metric-type]
|   |       +--rw metric-type
|   |         identityref
|   |       +--rw weight?
|   |         uint8
|   |       +--rw explicit-route-exclude-objects
|   |         +--rw route-object-exclude-object*
|   |           [index]
|   |             +--rw index
|   |               |
|   |                 uint32
|   |             +--rw (type)?
|   |               +--:(numbered-node-hop)
|   |                 |
|   |                   +--rw numbered-node-hop
|   |                     +--rw node-id
|   |                       |
|   |                         te-node-id
|   |                     +--rw hop-type?
|   |                       |
|   |                         te-hop-type
|   |               +--:(numbered-link-hop)
|   |                 |
|   |                   +--rw numbered-link-hop
|   |                     +--rw link-tp-id
|   |                       |
|   |                         te-tp-id
|   |                     +--rw hop-type?
|   |                       |
|   |                         te-hop-type
|   |                     +--rw direction?
|   |                       |
|   |                         te-link-direction
|   |               +--:(unnumbered-link-hop)
|   |                 |
|   |                   +--rw unnumbered-link-hop
|   |                     +--rw link-tp-id
|   |                       |
|   |                         te-tp-id
|   |                     +--rw node-id
|   |                       |
|   |                         te-node-id
|   |                     +--rw hop-type?
|   |                       |
|   |                         te-hop-type
|   |                     +--rw direction?
|   |                       |
|   |                         te-link-direction
|   |               +--:(as-number)
|   |                 |
|   |                   +--rw as-number-hop
|   |                     +--rw as-number
|   |                       |
|   |                         inet:as-number

```





```

|         |         +--ro usage          identityref
|         |         +--ro affinity-name* [name]
|         |         +--ro name          string
| +--ro path-srlgs-lists
|         | +--ro path-srlgs-list* [usage]
|         |         +--ro usage          identityref
|         |         +--ro values*      srlg
| +--ro path-srlgs-names
|         | +--ro path-srlgs-name* [usage]
|         |         +--ro usage          identityref
|         |         +--ro names*      string
| +--ro path-route-objects
|         +--ro path-route-object* [index]
|             +--ro index                uint32
|             +--ro (type)?
|                 +--:(numbered-node-hop)
|                     | +--ro numbered-node-hop
|                     |         +--ro node-id      te-node-id
|                     |         +--ro hop-type?    te-hop-type
|                 +--:(numbered-link-hop)
|                     | +--ro numbered-link-hop
|                     |         +--ro link-tp-id    te-tp-id
|                     |         +--ro hop-type?    te-hop-type
|                     |         +--ro direction?
|                     |                 te-link-direction
|                 +--:(unnumbered-link-hop)
|                     | +--ro unnumbered-link-hop
|                     |         +--ro link-tp-id    te-tp-id
|                     |         +--ro node-id      te-node-id
|                     |         +--ro hop-type?    te-hop-type
|                     |         +--ro direction?
|                     |                 te-link-direction
|                 +--:(as-number)
|                     | +--ro as-number-hop
|                     |         +--ro as-number    inet:as-number
|                     |         +--ro hop-type?    te-hop-type
|                 +--:(label)
|                     +--ro label-hop
|                     +--ro te-label
|                         +--ro (technology)?
|                             | +--:(generic)

```

```

    |                                     | +--ro generic?
    |                                     |         rt-
types:generalized-label
    |                                     +--ro direction?
    |                                     te-label-direction
+--ro oper-status?
    |         te-types:te-oper-status
+--ro geolocation
    | +--ro altitude?         int64
    | +--ro latitude?        geographic-coordinate-degree
    | +--ro longitude?       geographic-coordinate-degree
+--ro statistics
    | +--ro discontinuity-time?      yang:date-and-time
    | +--ro tunnel-termination-point
    | | +--ro disables?              yang:counter32
    | | +--ro enables?              yang:counter32
    | | +--ro maintenance-clears?   yang:counter32
    | | +--ro maintenance-sets?    yang:counter32
    | | +--ro modifies?            yang:counter32
    | | +--ro downs?               yang:counter32
    | | +--ro ups?                 yang:counter32
    | | +--ro in-service-clears?    yang:counter32
    | | +--ro in-service-sets?     yang:counter32
    | +--ro local-link-connectivity
    |   +--ro creates?              yang:counter32
    |   +--ro deletes?             yang:counter32
    |   +--ro disables?            yang:counter32
    |   +--ro enables?             yang:counter32
    |   +--ro modifies?            yang:counter32
+--rw supporting-tunnel-termination-point*
    [node-ref tunnel-tp-ref]
    +--rw node-ref                inet:uri
    +--rw tunnel-tp-ref           binary
augment /nw:networks/nw:network/nt:link:
+--rw te!
+--rw (bundle-stack-level)?
    | +--:(bundle)
    | | +--rw bundled-links
    | |   +--rw bundled-link* [sequence]
    | |     +--rw sequence      uint32
    | |     +--rw src-tp-ref?   leafref

```

```

| |         +--rw des-tp-ref?  leafref
| +--:(component)
|   +--rw component-links
|     +--rw component-link* [sequence]
|       +--rw sequence          uint32
|       +--rw src-interface-ref? string
|       +--rw des-interface-ref? string
+--rw te-link-template*
|   -> ../../../../te/templates/link-template/name
|   {template}?
+--rw te-link-attributes
| +--rw access-type?
| |     te-types:te-link-access-type
| +--rw external-domain
| | +--rw network-ref?
| | |     -> /nw:networks/network/network-id
| | +--rw remote-te-node-id?   te-types:te-node-id
| | +--rw remote-te-link-tp-id? te-types:te-tp-id
| +--rw is-abstract?          empty
| +--rw name?                 string
| +--rw underlay {te-topology-hierarchy}?
| | +--rw enabled?           boolean
| | +--rw primary-path
| | | +--rw network-ref?
| | | |     -> /nw:networks/network/network-id
| | | +--rw path-element* [path-element-id]
| | |   +--rw path-element-id          uint32
| | |   +--rw (type)?
| | |     +--:(numbered-node-hop)
| | |     | +--rw numbered-node-hop
| | |     |   +--rw node-id          te-node-id
| | |     |   +--rw hop-type?       te-hop-type
| | |     +--:(numbered-link-hop)
| | |     | +--rw numbered-link-hop
| | |     |   +--rw link-tp-id       te-tp-id
| | |     |   +--rw hop-type?       te-hop-type
| | |     |   +--rw direction?      te-link-direction
| | |     +--:(unnumbered-link-hop)
| | |     | +--rw unnumbered-link-hop
| | |     |   +--rw link-tp-id       te-tp-id
| | |     |   +--rw node-id         te-node-id

```

```

| | | | +--rw hop-type?      te-hop-type
| | | | +--rw direction?    te-link-direction
| | | | +---:(as-number)
| | | | | +--rw as-number-hop
| | | | | +--rw as-number    inet:as-number
| | | | | +--rw hop-type?   te-hop-type
| | | | +---:(label)
| | | | | +--rw label-hop
| | | | | +--rw te-label
| | | | | +--rw (technology)?
| | | | | | +---:(generic)
| | | | | | +--rw generic?
| | | | | | rt-types:generalized-
label
| | | | +--rw direction?
| | | | | te-label-direction
| | | | +--rw backup-path* [index]
| | | | | +--rw index          uint32
| | | | | +--rw network-ref?
| | | | | | -> /nw:networks/network/network-id
| | | | | +--rw path-element* [path-element-id]
| | | | | | +--rw path-element-id          uint32
| | | | | | +--rw (type)?
| | | | | | +---:(numbered-node-hop)
| | | | | | | +--rw numbered-node-hop
| | | | | | | +--rw node-id      te-node-id
| | | | | | | +--rw hop-type?   te-hop-type
| | | | | | +---:(numbered-link-hop)
| | | | | | | +--rw numbered-link-hop
| | | | | | | +--rw link-tp-id   te-tp-id
| | | | | | | +--rw hop-type?   te-hop-type
| | | | | | | +--rw direction?  te-link-direction
| | | | | | +---:(unnumbered-link-hop)
| | | | | | | +--rw unnumbered-link-hop
| | | | | | | +--rw link-tp-id   te-tp-id
| | | | | | | +--rw node-id     te-node-id
| | | | | | | +--rw hop-type?   te-hop-type
| | | | | | | +--rw direction?  te-link-direction
| | | | | +---:(as-number)
| | | | | +--rw as-number-hop
| | | | | +--rw as-number    inet:as-number

```

```

| | | | +-rw hop-type? te-hop-type
| | | | +--:(label)
| | | | +-rw label-hop
| | | | +-rw te-label
| | | | +-rw (technology)?
| | | | | +--:(generic)
| | | | | +-rw generic?
| | | | | rt-types:generalized-
label
| | | | +-rw direction?
| | | | | te-label-direction
| | +-rw protection-type? identityref
| | +-rw tunnel-termination-points
| | | +-rw source? binary
| | | +-rw destination? binary
| | +-rw tunnels
| | | +-rw sharing? boolean
| | | +-rw tunnel* [tunnel-name]
| | | | +-rw tunnel-name string
| | | | +-rw sharing? boolean
| +-rw admin-status?
| | te-types:te-admin-status
| +-rw link-index? uint64
| +-rw administrative-group?
| | te-types:admin-groups
| +-rw interface-switching-capability*
| | [switching-capability encoding]
| | +-rw switching-capability identityref
| | +-rw encoding identityref
| | +-rw max-lsp-bandwidth* [priority]
| | | +-rw priority uint8
| | | +-rw te-bandwidth
| | | | +-rw (technology)?
| | | | +--:(generic)
| | | | +-rw generic? te-bandwidth
| +-rw label-restrictions
| | +-rw label-restriction* [index]
| | | +-rw restriction? enumeration
| | | +-rw index uint32
| | | +-rw label-start
| | | | +-rw te-label

```



```

| | | +--rw (technology)?
| | | | +--:(generic)
| | | | +--rw generic?
| | | | | rt-types:generalized-label
| | | | +--rw direction? te-label-direction
| | +--rw label-end
| | | +--rw te-label
| | | | +--rw (technology)?
| | | | | +--:(generic)
| | | | | +--rw generic?
| | | | | | rt-types:generalized-label
| | | | | +--rw direction? te-label-direction
| | +--rw label-step
| | | +--rw (technology)?
| | | | +--:(generic)
| | | | | +--rw generic? int32
| | | +--rw range-bitmap? yang:hex-string
| +--rw link-protection-type? identityref
| +--rw max-link-bandwidth
| | +--rw te-bandwidth
| | | +--rw (technology)?
| | | | +--:(generic)
| | | | | +--rw generic? te-bandwidth
| +--rw max-resv-link-bandwidth
| | +--rw te-bandwidth
| | | +--rw (technology)?
| | | | +--:(generic)
| | | | | +--rw generic? te-bandwidth
| +--rw unreserved-bandwidth* [priority]
| | +--rw priority uint8
| | +--rw te-bandwidth
| | | +--rw (technology)?
| | | | +--:(generic)
| | | | | +--rw generic? te-bandwidth
| +--rw te-default-metric? uint32
| +--rw te-delay-metric? uint32
| +--rw te-igp-metric? uint32
| +--rw te-srlgs
| | +--rw value* te-types:srlg
| +--rw te-nsrlgs {nsrlg}?
| | +--rw id* uint32

```

```

+--ro oper-status?          te-types:te-oper-status
+--ro is-transitional?     empty
+--ro information-source?   te-info-source
+--ro information-source-instance? string
+--ro information-source-state
| +--ro credibility-preference? uint16
| +--ro logical-network-element? string
| +--ro network-instance?     string
| +--ro topology
|   +--ro link-ref?          leafref
|   +--ro network-ref?      -> /nw:networks/network/network-id
+--ro information-source-entry*
|   [information-source information-source-instance]
|   +--ro information-source          te-info-source
|   +--ro information-source-instance string
|   +--ro information-source-state
|   | +--ro credibility-preference? uint16
|   | +--ro logical-network-element? string
|   | +--ro network-instance?       string
|   | +--ro topology
|   |   +--ro link-ref?             leafref
|   |   +--ro network-ref?
|   |   -> /nw:networks/network/network-id
|   +--ro link-index?              uint64
|   +--ro administrative-group?
|   |   te-types:admin-groups
|   +--ro interface-switching-capability*
|   |   [switching-capability encoding]
|   |   +--ro switching-capability identityref
|   |   +--ro encoding              identityref
|   |   +--ro max-lsp-bandwidth* [priority]
|   |   +--ro priority              uint8
|   |   +--ro te-bandwidth
|   |     +--ro (technology)?
|   |     +--:(generic)
|   |     +--ro generic?           te-bandwidth
|   +--ro label-restrictions
|   | +--ro label-restriction* [index]
|   | +--ro restriction?        enumeration
|   | +--ro index               uint32
|   | +--ro label-start

```

```

| | | +--ro te-label
| | | | +--ro (technology)?
| | | | | +--:(generic)
| | | | | +--ro generic?
| | | | | | rt-types:generalized-label
| | | | | +--ro direction? te-label-direction
| | +--ro label-end
| | | +--ro te-label
| | | | +--ro (technology)?
| | | | | +--:(generic)
| | | | | +--ro generic?
| | | | | | rt-types:generalized-label
| | | | | +--ro direction? te-label-direction
| | +--ro label-step
| | | +--ro (technology)?
| | | | +--:(generic)
| | | | | +--ro generic? int32
| | +--ro range-bitmap? yang:hex-string
| +--ro link-protection-type? identityref
| +--ro max-link-bandwidth
| | +--ro te-bandwidth
| | | +--ro (technology)?
| | | | +--:(generic)
| | | | | +--ro generic? te-bandwidth
| +--ro max-resv-link-bandwidth
| | +--ro te-bandwidth
| | | +--ro (technology)?
| | | | +--:(generic)
| | | | | +--ro generic? te-bandwidth
| +--ro unreserved-bandwidth* [priority]
| | +--ro priority uint8
| | +--ro te-bandwidth
| | | +--ro (technology)?
| | | | +--:(generic)
| | | | | +--ro generic? te-bandwidth
| +--ro te-default-metric? uint32
| +--ro te-delay-metric? uint32
| +--ro te-igp-metric? uint32
| +--ro te-srlgs
| | +--ro value* te-types:srlg
| +--ro te-nsrlgs {nsrlg}?

```

```

|   +--ro id*   uint32
+--ro recovery
|   +--ro restoration-status?  te-types:te-recovery-status
|   +--ro protection-status?   te-types:te-recovery-status
+--ro underlay {te-topology-hierarchy}?
|   +--ro dynamic?   boolean
|   +--ro committed? boolean
+--ro statistics
  +--ro discontinuity-time?          yang:date-and-time
  +--ro disables?                   yang:counter32
  +--ro enables?                    yang:counter32
  +--ro maintenance-clears?         yang:counter32
  +--ro maintenance-sets?          yang:counter32
  +--ro modifies?                   yang:counter32
  +--ro downs?                      yang:counter32
  +--ro ups?                        yang:counter32
  +--ro fault-clears?               yang:counter32
  +--ro fault-detects?              yang:counter32
  +--ro protection-switches?        yang:counter32
  +--ro protection-reverts?         yang:counter32
  +--ro restoration-failures?       yang:counter32
  +--ro restoration-starts?         yang:counter32
  +--ro restoration-successes?     yang:counter32
  +--ro restoration-reversion-failures? yang:counter32
  +--ro restoration-reversion-starts? yang:counter32
  +--ro restoration-reversion-successes? yang:counter32
augment /nw:networks/nw:network/nw:node/nt:termination-point:
+--rw te-tp-id?  te-types:te-tp-id
+--rw te!
  +--rw admin-status?
  |   te-types:te-admin-status
  +--rw name?                    string
  +--rw interface-switching-capability*
  |   [switching-capability encoding]
  |   +--rw switching-capability  identityref
  |   +--rw encoding              identityref
  |   +--rw max-lsp-bandwidth* [priority]
  |   |   +--rw priority          uint8
  |   |   +--rw te-bandwidth
  |   |   +--rw (technology)?
  |   |   +--:(generic)

```

```
|           +--rw generic?   te-bandwidth
+--rw inter-domain-plug-id?      binary
+--rw inter-layer-lock-id*       uint32
+--ro oper-status?
|           te-types:te-oper-status
+--ro geolocation
  +--ro altitude?      int64
  +--ro latitude?     geographic-coordinate-degree
  +--ro longitude?    geographic-coordinate-degree
```

## **Appendix B. Companion YANG Model for Non-NMDA Compliant Implementations**

The YANG module `ietf-te-topology` defined in this document is designed to be used in conjunction with implementations that support the Network Management Datastore Architecture (NMDA) defined in [\[RFC8342\]](#). In order to allow implementations to use the model even in cases when NMDA is not supported, the following companion module `ietf-te-topology-state` is defined as a state model, which mirrors the module `ietf-te-topology` defined earlier in this document. However, all data nodes in the companion module are non-configurable, to represent the applied configuration or the derived operational states.

The companion module, `ietf-te-topology-state`, is redundant and SHOULD NOT be supported by implementations that support NMDA.

As the structure of the module `ietf-te-topology-state` mirrors that of the module `ietf-te-topology`. The YANG tree of the module `ietf-te-topology-state` is not depicted separately.

### **B.1. TE Topology State YANG Module**

This module references [\[RFC6001\]](#), [\[RFC8345\]](#), and [\[I-D.ietf-teas-yang-te-types\]](#).

```
<CODE BEGINS> file "ietf-te-topology-state@2019-02-07.yang"
module ietf-te-topology-state {
  yang-version 1.1;
  namespace "urn:ietf:params:xml:ns:yang:ietf-te-topology-state";

  prefix "tet-s";

  import ietf-te-types {
    prefix "te-types";
    reference
      "I-D.ietf-teas-yang-te-types: Traffic Engineering Common YANG
      Types";
  }

  import ietf-te-topology {
    prefix "tet";
  }

  import ietf-network-state {
```

```
    prefix "nw-s";
    reference "RFC 8345: A YANG Data Model for Network Topologies";
  }

import ietf-network-topology-state {
  prefix "nt-s";
  reference "RFC 8345: A YANG Data Model for Network Topologies";
}

organization
  "IETF Traffic Engineering Architecture and Signaling (TEAS)
  Working Group";

contact
  "WG Web:   <http://tools.ietf.org/wg/teas/>
  WG List:  <mailto:teas@ietf.org>

  Editor:   Xufeng Liu
            <mailto:xufeng.liu.ietf@gmail.com>

  Editor:   Igor Bryskin
            <mailto:Igor.Bryskin@huawei.com>

  Editor:   Vishnu Pavan Beeram
            <mailto:vbeeram@juniper.net>

  Editor:   Tarek Saad
            <mailto:tsaad@juniper.net>

  Editor:   Himanshu Shah
            <mailto:hshah@ciena.com>

  Editor:   Oscar Gonzalez De Dios
            <mailto:oscar.gonzalezdedios@telefonica.com>";

description
  "TE topology state model.

  Copyright (c) 2019 IETF Trust and the persons identified as
  authors of the code. All rights reserved.
```

Redistribution and use in source and binary forms, with or without modification, is permitted pursuant to, and subject to the license terms contained in, the Simplified BSD License set forth in [Section 4.c](#) of the IETF Trust's Legal Provisions Relating to IETF Documents (<http://trustee.ietf.org/license-info>).

This version of this YANG module is part of RFC XXXX; see the RFC itself for full legal notices.";

```
revision "2019-02-07" {
  description "Initial revision";
  reference "RFC XXXX: YANG Data Model for TE Topologies";
  // RFC Ed.: replace XXXX with actual RFC number and remove
  // this note
}

/*
 * Groupings
 */
grouping te-node-connectivity-matrix-attributes {
  description
    "Termination point references of a connectivity matrix entry.";
  container from {
    description
      "Reference to source link termination point.";
    leaf tp-ref {
      type leafref {
        path "../.../.../.../nt-s:termination-point/nt-s:tp-id";
      }
      description
        "Relative reference to a termination point.";
    }
    uses te-types:label-set-info;
  }
  container to {
    description
      "Reference to destination link termination point.";
    leaf tp-ref {
      type leafref {
        path "../.../.../.../nt-s:termination-point/nt-s:tp-id";
      }
    }
  }
}
```



```

    }
    description
      "Relative reference to a termination point.";
  }
  uses te-types:label-set-info;
}
uses tet:connectivity-matrix-entry-path-attributes;
} // te-node-connectivity-matrix-attributes

grouping te-node-tunnel-termination-point-llc-list {
  description
    "Local link connectivity list of a tunnel termination
    point on a TE node.";
  list local-link-connectivity {
    key "link-tp-ref";
    description
      "The termination capabilities between
      tunnel-termination-point and link termination-point.
      The capability information can be used to compute
      the tunnel path.
      The Interface Adjustment Capability Descriptors (IACD)
      (defined in RFC 6001) on each link-tp can be derived from
      this local-link-connectivity list.";
    reference
      "RFC 6001: Generalized MPLS (GMPLS) Protocol Extensions
      for Multi-Layer and Multi-Region Networks (MLN/MRN).";

    leaf link-tp-ref {
      type leafref {
        path "../.../nt-s:termination-point/nt-s:tp-id";
      }
      description
        "Link termination point.";
    }
    uses te-types:label-set-info;
    uses tet:connectivity-matrix-entry-path-attributes;
  } // local-link-connectivity
} // te-node-tunnel-termination-point-config

/*
 * Data nodes

```

```
*/
augment "/nw-s:networks/nw-s:network/nw-s:network-types" {
  description
    "Introduce new network type for TE topology.";
  container te-topology {
    presence "Indicates TE topology.";
    description
      "Its presence identifies the TE topology type.";
  }
}

augment "/nw-s:networks" {
  description
    "Augmentation parameters for TE topologies.";
  uses tet:te-topologies-augment;
}

augment "/nw-s:networks/nw-s:network" {
  when "nw-s:network-types/tet-s:te-topology" {
    description
      "Augmentation parameters apply only for networks with
      TE topology type.";
  }
  description
    "Configuration parameters for TE topology.";
  uses tet:te-topology-augment;
}

augment "/nw-s:networks/nw-s:network/nw-s:node" {
  when "../nw-s:network-types/tet-s:te-topology" {
    description
      "Augmentation parameters apply only for networks with
      TE topology type.";
  }
  description
    "Configuration parameters for TE at node level.";
  leaf te-node-id {
    type te-types:te-node-id;
    description
      "The identifier of a node in the TE topology.
      A node is specific to a topology to which it belongs.";
  }
}
```

```
    }
  container te {
    must "../te-node-id" {
      description
        "te-node-id is mandatory.";
    }
    must "count(..nw-s:supporting-node)<=1" {
      description
        "For a node in a TE topology, there cannot be more
        than 1 supporting node. If multiple nodes are abstracted,
        the underlay-topology is used.";
    }
    presence "TE support.";
    description
      "Indicates TE support.";
    uses tet:te-node-augment;
  } // te
}

augment "/nw-s:networks/nw-s:network/nt-s:link" {
  when "../nw-s:network-types/tet-s:te-topology" {
    description
      "Augmentation parameters apply only for networks with
      TE topology type.";
  }
  description
    "Configuration parameters for TE at link level.";
  container te {
    must "count(..nt-s:supporting-link)<=1" {
      description
        "For a link in a TE topology, there cannot be more
        than 1 supporting link. If one or more link paths are
        abstracted, the underlay is used.";
    }
    presence "TE support.";
    description
      "Indicates TE support.";
    uses tet:te-link-augment;
  } // te
}
```

```
augment "/nw-s:networks/nw-s:network/nw-s:node/"
  + "nt-s:termination-point" {
  when "../..//nw-s:network-types/tet-s:te-topology" {
    description
      "Augmentation parameters apply only for networks with
      TE topology type.";
  }
  description
    "Configuration parameters for TE at termination point level.";
  uses tet:te-termination-point-augment;
}

augment
"/nw-s:networks/nw-s:network/nt-s:link/te/bundle-stack-level/"
+ "bundle/bundled-links/bundled-link" {
  when "../..//..//..//nw-s:network-types/tet-s:te-topology" {
    description
      "Augmentation parameters apply only for networks with
      TE topology type.";
  }
  description
    "Augment TE link bundled link.";
  leaf src-tp-ref {
    type leafref {
      path "../..//..//..//nw-s:node[nw-s:node-id = "
        + "current()/../..//..//nt-s:source/"
        + "nt-s:source-node]/"
        + "nt-s:termination-point/nt-s:tp-id";
      require-instance true;
    }
    description
      "Reference to another TE termination point on the
      same source node.";
  }
  leaf des-tp-ref {
    type leafref {
      path "../..//..//..//nw-s:node[nw-s:node-id = "
        + "current()/../..//..//nt-s:destination/"
        + "nt-s:dest-node]/"
        + "nt-s:termination-point/nt-s:tp-id";
      require-instance true;
    }
  }
}
```

```
    }
    description
      "Reference to another TE termination point on the
       same destination node.";
  }
}

augment
  "/nw-s:networks/nw-s:network/nw-s:node/te/"
+ "information-source-entry/connectivity-matrices/"
+ "connectivity-matrix" {
  when "../..../nw-s:network-types/tet-s:te-topology" {
    description
      "Augmentation parameters apply only for networks with
       TE topology type.";
  }
  description
    "Augment TE node connectivity-matrix.";
  uses te-node-connectivity-matrix-attributes;
}

augment
  "/nw-s:networks/nw-s:network/nw-s:node/te/te-node-attributes/"
+ "connectivity-matrices/connectivity-matrix" {
  when "../..../nw-s:network-types/tet-s:te-topology" {
    description
      "Augmentation parameters apply only for networks with
       TE topology type.";
  }
  description
    "Augment TE node connectivity-matrix.";
  uses te-node-connectivity-matrix-attributes;
}

augment
  "/nw-s:networks/nw-s:network/nw-s:node/te/"
+ "tunnel-termination-point/local-link-connectivities" {
  when "../..../nw-s:network-types/tet-s:te-topology" {
    description
      "Augmentation parameters apply only for networks with
       TE topology type.";
  }
}
```

```
    }  
    description  
      "Augment TE node tunnel termination point LLCs  
      (Local Link Connectivities).";  
    uses te-node-tunnel-termination-point-llc-list;  
  }  
}  
<CODE ENDS>
```

### [Appendix C](#). Example: YANG Model for Technology Specific Augmentations

This section provides an example YANG module to define a technology specific TE topology model for the example-topology described in [Section 6](#).

```
module example-topology {
  yang-version 1.1;

  namespace "http://example.com/example-topology";
  prefix "ex-topo";

  import ietf-network {
    prefix "nw";
  }

  import ietf-network-topology {
    prefix "nt";
  }

  import ietf-te-topology {
    prefix "tet";
  }

  organization
    "Example Organization";
  contact
    "Editor: Example Author";

  description
    "This module defines a topology data model for the example
    technology.";

  revision 2018-06-15 {
    description
      "Initial revision.";
    reference
      "Example reference.";
  }

  /*
   * Data nodes
```

```
*/
augment "/nw:networks/nw:network/nw:network-types/"
+ "tet:te-topology" {
  description
    "Augment network types to define example topology type.";
  container example-topology {
    presence
      "Introduce new network type for example topology.";
    description
      "Its presence identifies the example topology type.";
  }
}

augment "/nw:networks/nw:network/tet:te" {
  when "../nw:network-types/tet:te-topology/"
  + "ex-topo:example-topology" {
    description
      "Augmentation parameters apply only for networks with
      example topology type.";
  }
  description "Augment network topology.";
  container attributes {
    description "Attributes for example technology.";
    leaf attribute-1 {
      type uint8;
      description "Attribute 1 for example technology.";
    }
  }
}

augment "/nw:networks/nw:network/nw:node/tet:te/"
+ "tet:te-node-attributes" {
  when "../..../nw:network-types/tet:te-topology/"
  + "ex-topo:example-topology" {
    description
      "Augmentation parameters apply only for networks with
      example topology type.";
  }
  description "Augment node attributes.";
  container attributes {
    description "Attributes for example technology.";
  }
}
```



```
    leaf attribute-2 {
      type uint8;
      description "Attribute 2 for example technology.";
    }
  }
}

augment "/nw:networks/nw:network/nw:node/tet:te/"
+ "tet:te-node-attributes/tet:connectivity-matrices" {
  when "../../../nw:network-types/tet:te-topology/"
  + "ex-topo:example-topology" {
    description
      "Augmentation parameters apply only for networks with
      example topology type.";
  }
  description "Augment node connectivity matrices.";
  container attributes {
    description "Attributes for example technology.";
    leaf attribute-3 {
      type uint8;
      description "Attribute 3 for example technology.";
    }
  }
}

augment "/nw:networks/nw:network/nw:node/tet:te/"
+ "tet:te-node-attributes/tet:connectivity-matrices/"
+ "tet:connectivity-matrix" {
  when "../../../nw:network-types/tet:te-topology/"
  + "ex-topo:example-topology" {
    description
      "Augmentation parameters apply only for networks with
      example topology type.";
  }
  description "Augment node connectivity matrix.";
  container attributes {
    description "Attributes for example technology.";
    leaf attribute-3 {
      type uint8;
      description "Attribute 3 for example technology.";
    }
  }
}
```

```
    }
  }

  augment "/nw:networks/nw:network/nw:node/tet:te/"
  + "tet:tunnel-termination-point" {
    when "../../../nw:network-types/tet:te-topology/"
      + "ex-topo:example-topology" {
      description
        "Augmentation parameters apply only for networks with
        example topology type.";
    }
    description "Augment tunnel termination point.";
    container attributes {
      description "Attributes for example technology.";
      leaf attribute-4 {
        type uint8;
        description "Attribute 4 for example technology.";
      }
    }
  }

  augment "/nw:networks/nw:network/nw:node/nt:termination-point/"
  + "tet:te" {
    when "../../../nw:network-types/tet:te-topology/"
      + "ex-topo:example-topology" {
      description
        "Augmentation parameters apply only for networks with
        example topology type.";
    }
    description "Augment link termination point.";
    container attributes {
      description "Attributes for example technology.";
      leaf attribute-5 {
        type uint8;
        description "Attribute 5 for example technology.";
      }
    }
  }

  augment "/nw:networks/nw:network/nt:link/tet:te/"
  + "tet:te-link-attributes" {
```

```
when "../../../nw:network-types/tet:te-topology/"
  + "ex-topo:example-topology" {
  description
    "Augmentation parameters apply only for networks with
    example topology type.";
}
description "Augment link attributes.";
container attributes {
  description "Attributes for example technology.";
  leaf attribute-6 {
    type uint8;
    description "Attribute 6 for example technology.";
  }
}
}

/*
 * Augment TE bandwidth.
 */

augment "/nw:networks/tet:te/tet:templates/"
  + "tet:link-template/tet:te-link-attributes/"
  + "tet:interface-switching-capability/tet:max-lsp-bandwidth/"
  + "tet:te-bandwidth/tet:technology" {
  case "example" {
    container example {
      description "Attributes for example technology.";
      leaf bandwidth-1 {
        type uint32;
        description "Bandwidth 1 for example technology.";
      }
    }
  }
}
description "Augment TE bandwidth.";
}

augment "/nw:networks/tet:te/tet:templates/"
  + "tet:link-template/tet:te-link-attributes/"
  + "tet:max-link-bandwidth/"
  + "tet:te-bandwidth/tet:technology" {
  case "example" {
```

```
    container example {
      description "Attributes for example technology.";
      leaf bandwidth-1 {
        type uint32;
        description "Bandwidth 1 for example technology.";
      }
    }
  }
  description "Augment TE bandwidth.";
}

augment "/nw:networks/tet:te/tet:templates/"
+ "tet:link-template/tet:te-link-attributes/"
+ "tet:max-resv-link-bandwidth/"
+ "tet:te-bandwidth/tet:technology" {
  case "example" {
    container example {
      description "Attributes for example technology.";
      leaf bandwidth-1 {
        type uint32;
        description "Bandwidth 1 for example technology.";
      }
    }
  }
  description "Augment TE bandwidth.";
}

augment "/nw:networks/tet:te/tet:templates/"
+ "tet:link-template/tet:te-link-attributes/"
+ "tet:unreserved-bandwidth/"
+ "tet:te-bandwidth/tet:technology" {
  case "example" {
    container example {
      description "Attributes for example technology.";
      leaf bandwidth-1 {
        type uint32;
        description "Bandwidth 1 for example technology.";
      }
    }
  }
  description "Augment TE bandwidth.";
```

```

}

augment "/nw:networks/nw:network/nw:node/tet:te/"
+ "tet:te-node-attributes/tet:connectivity-matrices/"
+ "tet:path-constraints/tet:te-bandwidth/tet:technology" {
when "../../../../../../../nw:network-types/tet:te-topology/"
+ "ex-topo:example-topology" {
description
  "Augmentation parameters apply only for networks with
  example topology type.";
}
case "example" {
container example {
description "Attributes for example technology.";
leaf bandwidth-1 {
type uint32;
description "Bandwidth 1 for example technology.";
}
}
}
description "Augment TE bandwidth.";
}

augment "/nw:networks/nw:network/nw:node/tet:te/"
+ "tet:te-node-attributes/tet:connectivity-matrices/"
+ "tet:connectivity-matrix/"
+ "tet:path-constraints/tet:te-bandwidth/tet:technology" {
when "../../../../../../../nw:network-types/tet:te-topology/"
+ "ex-topo:example-topology" {
description
  "Augmentation parameters apply only for networks with
  example topology type.";
}
case "example" {
container example {
description "Attributes for example technology.";
leaf bandwidth-1 {
type uint32;
description "Bandwidth 1 for example technology.";
}
}
}
}

```

```

    }
    description "Augment TE bandwidth.";
  }

  augment "/nw:networks/nw:network/nw:node/tet:te/"
    + "tet:information-source-entry/tet:connectivity-matrices/"
    + "tet:path-constraints/tet:te-bandwidth/tet:technology" {
    when "../../../../../../../../../../../nw:network-types/tet:te-topology/"
      + "ex-topo:example-topology" {
      description
        "Augmentation parameters apply only for networks with
        example topology type.";
    }
    case "example" {
      container example {
        description "Attributes for example technology.";
        leaf bandwidth-1 {
          type uint32;
          description "Bandwidth 1 for example technology.";
        }
      }
    }
  }
  description "Augment TE bandwidth.";
}

augment "/nw:networks/nw:network/nw:node/tet:te/"
  + "tet:information-source-entry/tet:connectivity-matrices/"
  + "tet:connectivity-matrix/"
  + "tet:path-constraints/tet:te-bandwidth/tet:technology" {
  when "../../../../../../../../../../../nw:network-types/tet:te-topology/"
    + "ex-topo:example-topology" {
    description
      "Augmentation parameters apply only for networks with
      example topology type.";
  }
  case "example" {
    container example {
      description "Attributes for example technology.";
      leaf bandwidth-1 {
        type uint32;
        description "Bandwidth 1 for example technology.";
      }
    }
  }
}

```

```

    }
  }
}
description "Augment TE bandwidth.";
}

augment "/nw:networks/nw:network/nw:node/tet:te/"
+ "tet:tunnel-termination-point/tet:client-layer-adaptation/"
+ "tet:switching-capability/tet:te-bandwidth/tet:technology" {
when "../../../../../../../nw:network-types/tet:te-topology/"
+ "ex-topo:example-topology" {
description
  "Augmentation parameters apply only for networks with
  example topology type.";
}
case "example" {
container example {
description "Attributes for example technology.";
leaf bandwidth-1 {
type uint32;
description "Bandwidth 1 for example technology.";
}
}
}
description "Augment TE bandwidth.";
}

augment "/nw:networks/nw:network/nw:node/tet:te/"
+ "tet:tunnel-termination-point/tet:local-link-connectivities/"
+ "tet:path-constraints/tet:te-bandwidth/tet:technology" {
when "../../../../../../../nw:network-types/tet:te-topology/"
+ "ex-topo:example-topology" {
description
  "Augmentation parameters apply only for networks with
  example topology type.";
}
case "example" {
container example {
description "Attributes for example technology.";
leaf bandwidth-1 {
type uint32;

```

```
        description "Bandwidth 1 for example technology.";
    }
}
}
description "Augment TE bandwidth.";
}

augment "/nw:networks/nw:network/nw:node/tet:te/"
+ "tet:tunnel-termination-point/tet:local-link-connectivities/"
+ "tet:local-link-connectivity/"
+ "tet:path-constraints/tet:te-bandwidth/tet:technology" {
when "../../../../../../../../../../../nw:network-types/tet:te-topology/"
+ "ex-topo:example-topology" {
description
    "Augmentation parameters apply only for networks with
    example topology type.";
}
case "example" {
container example {
description "Attributes for example technology.";
leaf bandwidth-1 {
type uint32;
description "Bandwidth 1 for example technology.";
}
}
}
description "Augment TE bandwidth.";
}

augment "/nw:networks/nw:network/nt:link/tet:te/"
+ "tet:te-link-attributes/"
+ "tet:interface-switching-capability/tet:max-lsp-bandwidth/"
+ "tet:te-bandwidth/tet:technology" {
when "../../../../../../../../../../../nw:network-types/tet:te-topology/"
+ "ex-topo:example-topology" {
description
    "Augmentation parameters apply only for networks with
    example topology type.";
}
case "example" {
container example {
```



```

        description "Attributes for example technology.";
        leaf bandwidth-1 {
            type uint32;
            description "Bandwidth 1 for example technology.";
        }
    }
}
description "Augment TE bandwidth.";
}

augment "/nw:networks/nw:network/nt:link/tet:te/"
+ "tet:te-link-attributes/"
+ "tet:max-link-bandwidth/"
+ "tet:te-bandwidth/tet:technology" {
when "../../../../../../../nw:network-types/tet:te-topology/"
+ "ex-topo:example-topology" {
description
    "Augmentation parameters apply only for networks with
    example topology type.";
}
case "example" {
    container example {
        description "Attributes for example technology.";
        leaf bandwidth-1 {
            type uint32;
            description "Bandwidth 1 for example technology.";
        }
    }
}
description "Augment TE bandwidth.";
}

augment "/nw:networks/nw:network/nt:link/tet:te/"
+ "tet:te-link-attributes/"
+ "tet:max-resv-link-bandwidth/"
+ "tet:te-bandwidth/tet:technology" {
when "../../../../../../../nw:network-types/tet:te-topology/"
+ "ex-topo:example-topology" {
description
    "Augmentation parameters apply only for networks with
    example topology type.";
}
}

```

```

    }
    case "example" {
      container example {
        description "Attributes for example technology.";
        leaf bandwidth-1 {
          type uint32;
          description "Bandwidth 1 for example technology.";
        }
      }
    }
    description "Augment TE bandwidth.";
  }

augment "/nw:networks/nw:network/nt:link/tet:te/"
+ "tet:information-source-entry/"
+ "tet:interface-switching-capability/tet:max-lsp-bandwidth/"
+ "tet:te-bandwidth/tet:technology" {
when "../../../../../../../nw:network-types/tet:te-topology/"
+ "ex-topo:example-topology" {
  description
    "Augmentation parameters apply only for networks with
    example topology type.";
}
case "example" {
  container example {
    description "Attributes for example technology.";
    leaf bandwidth-1 {
      type uint32;
      description "Bandwidth 1 for example technology.";
    }
  }
}
description "Augment TE bandwidth.";
}

augment "/nw:networks/nw:network/nt:link/tet:te/"
+ "tet:information-source-entry/"
+ "tet:max-link-bandwidth/"
+ "tet:te-bandwidth/tet:technology" {
when "../../../../../../../nw:network-types/tet:te-topology/"
+ "ex-topo:example-topology" {

```

```

    description
      "Augmentation parameters apply only for networks with
      example topology type.";
  }
  case "example" {
    container example {
      description "Attributes for example technology.";
      leaf bandwidth-1 {
        type uint32;
        description "Bandwidth 1 for example technology.";
      }
    }
  }
  description "Augment TE bandwidth.";
}

augment "/nw:networks/nw:network/nt:link/tet:te/"
+ "tet:information-source-entry/"
+ "tet:max-resv-link-bandwidth/"
+ "tet:te-bandwidth/tet:technology" {
when "../../../nw:network-types/tet:te-topology/"
+ "ex-topo:example-topology" {
  description
    "Augmentation parameters apply only for networks with
    example topology type.";
}
case "example" {
  container example {
    description "Attributes for example technology.";
    leaf bandwidth-1 {
      type uint32;
      description "Bandwidth 1 for example technology.";
    }
  }
}
description "Augment TE bandwidth.";
}

augment "/nw:networks/nw:network/nt:link/tet:te/"
+ "tet:information-source-entry/"
+ "tet:unreserved-bandwidth/"

```

```

+ "tet:te-bandwidth/tet:technology" {
when "../../../../../../../nw:network-types/tet:te-topology/"
  + "ex-topo:example-topology" {
  description
    "Augmentation parameters apply only for networks with
    example topology type.";
}
case "example" {
  container example {
    description "Attributes for example technology.";
    leaf bandwidth-1 {
      type uint32;
      description "Bandwidth 1 for example technology.";
    }
  }
}
description "Augment TE bandwidth.";
}

augment "/nw:networks/nw:network/nw:node/nt:termination-point/"
+ "tet:te/"
+ "tet:interface-switching-capability/tet:max-lsp-bandwidth/"
+ "tet:te-bandwidth/tet:technology" {
when "../../../../../../../nw:network-types/tet:te-topology/"
  + "ex-topo:example-topology" {
  description
    "Augmentation parameters apply only for networks with
    example topology type.";
}
case "example" {
  container example {
    description "Attributes for example technology.";
    leaf bandwidth-1 {
      type uint32;
      description "Bandwidth 1 for example technology.";
    }
  }
}
description "Augment TE bandwidth.";
}

```

```
/*
 * Augment TE label.
 */

augment "/nw:networks/tet:te/tet:templates/"
+ "tet:link-template/tet:te-link-attributes/"
+ "tet:underlay/tet:primary-path/tet:path-element/tet:type/"
+ "tet:label/tet:label-hop/tet:te-label/tet:technology" {
case "example" {
  container example {
    description "Attributes for example technology.";
    leaf label-1 {
      type uint32;
      description "Label 1 for example technology.";
    }
  }
}
description "Augment TE label.";
}

augment "/nw:networks/tet:te/tet:templates/"
+ "tet:link-template/tet:te-link-attributes/"
+ "tet:underlay/tet:backup-path/tet:path-element/tet:type/"
+ "tet:label/tet:label-hop/tet:te-label/tet:technology" {
case "example" {
  container example {
    description "Attributes for example technology.";
    leaf label-1 {
      type uint32;
      description "Label 1 for example technology.";
    }
  }
}
description "Augment TE label.";
}

augment "/nw:networks/tet:te/tet:templates/"
+ "tet:link-template/tet:te-link-attributes/"
+ "tet:label-restrictions/tet:label-restriction/tet:label-start/"
+ "tet:te-label/tet:technology" {
case "example" {
```

```

    container example {
      description "Attributes for example technology.";
      leaf label-1 {
        type uint32;
        description "Label 1 for example technology.";
      }
    }
  }
  description "Augment TE label.";
}

augment "/nw:networks/tet:te/tet:templates/"
+ "tet:link-template/tet:te-link-attributes/"
+ "tet:label-restrictions/tet:label-restriction/tet:label-end/"
+ "tet:te-label/tet:technology" {
  case "example" {
    container example {
      description "Attributes for example technology.";
      leaf label-1 {
        type uint32;
        description "Label 1 for example technology.";
      }
    }
  }
  description "Augment TE label.";
}

/* Under te-node-attributes/connectivity-matrices */

augment "/nw:networks/nw:network/nw:node/tet:te/"
+ "tet:te-node-attributes/tet:connectivity-matrices/"
+ "tet:label-restrictions/tet:label-restriction/tet:label-start/"
+ "tet:te-label/tet:technology" {
  when "../../../../../../../nw:network-types/tet:te-topology/"
  + "ex-topo:example-topology" {
    description
      "Augmentation parameters apply only for networks with
      example topology type.";
  }
  case "example" {
    container example {

```

```

        description "Attributes for example technology.";
        leaf label-1 {
            type uint32;
            description "Label 1 for example technology.";
        }
    }
}
description "Augment TE label.";
}

augment "/nw:networks/nw:network/nw:node/tet:te/"
+ "tet:te-node-attributes/tet:connectivity-matrices/"
+ "tet:label-restrictions/tet:label-restriction/tet:label-end/"
+ "tet:te-label/tet:technology" {
when "../../../../../../../../../../../nw:network-types/tet:te-topology/"
+ "ex-topo:example-topology" {
description
    "Augmentation parameters apply only for networks with
    example topology type.";
}
case "example" {
    container example {
        description "Attributes for example technology.";
        leaf label-1 {
            type uint32;
            description "Label 1 for example technology.";
        }
    }
}
description "Augment TE label.";
}

augment "/nw:networks/nw:network/nw:node/tet:te/"
+ "tet:te-node-attributes/tet:connectivity-matrices/"
+ "tet:underlay/tet:primary-path/tet:path-element/tet:type/"
+ "tet:label/tet:label-hop/tet:te-label/tet:technology" {
when "../../../../../../../../../../../nw:network-types/"
+ "tet:te-topology/ex-topo:example-topology" {
description
    "Augmentation parameters apply only for networks with
    example topology type.";
}
}

```

```

    }
    case "example" {
      container example {
        description "Attributes for example technology.";
        leaf label-1 {
          type uint32;
          description "Label 1 for example technology.";
        }
      }
    }
    description "Augment TE label.";
  }

augment "/nw:networks/nw:network/nw:node/tet:te/"
+ "tet:te-node-attributes/tet:connectivity-matrices/"
+ "tet:underlay/tet:backup-path/tet:path-element/tet:type/"
+ "tet:label/tet:label-hop/tet:te-label/tet:technology" {
when "../../../../../../../../../../../../../../../nw:network-types/"
+ "tet:te-topology/ex-topo:example-topology" {
  description
    "Augmentation parameters apply only for networks with
    example topology type.";
}
case "example" {
  container example {
    description "Attributes for example technology.";
    leaf label-1 {
      type uint32;
      description "Label 1 for example technology.";
    }
  }
}
description "Augment TE label.";
}

augment "/nw:networks/nw:network/nw:node/tet:te/"
+ "tet:te-node-attributes/tet:connectivity-matrices/"
+ "tet:path-properties/tet:path-route-objects/"
+ "tet:path-route-object/tet:type/"
+ "tet:label/tet:label-hop/tet:te-label/tet:technology" {
when "../../../../../../../../../../../../../../../nw:network-types/"

```



```

    + "tet:te-topology/ex-topo:example-topology" {
      description
        "Augmentation parameters apply only for networks with
        example topology type.";
    }
  case "example" {
    container example {
      description "Attributes for example technology.";
      leaf label-1 {
        type uint32;
        description "Label 1 for example technology.";
      }
    }
  }
  description "Augment TE label.";
}

/* Under te-node-attributes/.../connectivity-matrix */

augment "/nw:networks/nw:network/nw:node/tet:te/"
+ "tet:te-node-attributes/tet:connectivity-matrices/"
+ "tet:connectivity-matrix/tet:from/"
+ "tet:label-restrictions/tet:label-restriction/tet:label-start/"
+ "tet:te-label/tet:technology" {
when "../../../../../../../../../../../nw:network-types/"
+ "tet:te-topology/ex-topo:example-topology" {
  description
    "Augmentation parameters apply only for networks with
    example topology type.";
}
case "example" {
  container example {
    description "Attributes for example technology.";
    leaf label-1 {
      type uint32;
      description "Label 1 for example technology.";
    }
  }
}
description "Augment TE label.";
}

```

```

augment "/nw:networks/nw:network/nw:node/tet:te/"
+ "tet:te-node-attributes/tet:connectivity-matrices/"
+ "tet:connectivity-matrix/tet:from/"
+ "tet:label-restrictions/tet:label-restriction/tet:label-end/"
+ "tet:te-label/tet:technology" {
when "../../../../../../../../../../../../../../../nw:network-types/"
+ "tet:te-topology/ex-topo:example-topology" {
description
  "Augmentation parameters apply only for networks with
  example topology type.";
}
case "example" {
  container example {
    description "Attributes for example technology.";
    leaf label-1 {
      type uint32;
      description "Label 1 for example technology.";
    }
  }
}
description "Augment TE label.";
}

augment "/nw:networks/nw:network/nw:node/tet:te/"
+ "tet:te-node-attributes/tet:connectivity-matrices/"
+ "tet:connectivity-matrix/tet:to/"
+ "tet:label-restrictions/tet:label-restriction/tet:label-start/"
+ "tet:te-label/tet:technology" {
when "../../../../../../../../../../../../../../../nw:network-types/"
+ "tet:te-topology/ex-topo:example-topology" {
description
  "Augmentation parameters apply only for networks with
  example topology type.";
}
case "example" {
  container example {
    description "Attributes for example technology.";
    leaf label-1 {
      type uint32;
      description "Label 1 for example technology.";
    }
  }
}

```

```

    }
  }
}
description "Augment TE label.";
}

augment "/nw:networks/nw:network/nw:node/tet:te/"
+ "tet:te-node-attributes/tet:connectivity-matrices/"
+ "tet:connectivity-matrix/tet:to/"
+ "tet:label-restrictions/tet:label-restriction/tet:label-end/"
+ "tet:te-label/tet:technology" {
when "../../../../../../../../../../../../../../../nw:network-types/"
+ "tet:te-topology/ex-topo:example-topology" {
description
  "Augmentation parameters apply only for networks with
  example topology type.";
}
case "example" {
  container example {
    description "Attributes for example technology.";
    leaf label-1 {
      type uint32;
      description "Label 1 for example technology.";
    }
  }
}
}
description "Augment TE label.";
}

augment "/nw:networks/nw:network/nw:node/tet:te/"
+ "tet:te-node-attributes/tet:connectivity-matrices/"
+ "tet:connectivity-matrix/"
+ "tet:underlay/tet:primary-path/tet:path-element/tet:type/"
+ "tet:label/tet:label-hop/tet:te-label/tet:technology" {
when "../../../../../../../../../../../../../../../nw:network-types/"
+ "tet:te-topology/ex-topo:example-topology" {
description
  "Augmentation parameters apply only for networks with
  example topology type.";
}
case "example" {

```

```

    container example {
      description "Attributes for example technology.";
      leaf label-1 {
        type uint32;
        description "Label 1 for example technology.";
      }
    }
  }
  description "Augment TE label.";
}

augment "/nw:networks/nw:network/nw:node/tet:te/"
+ "tet:te-node-attributes/tet:connectivity-matrices/"
+ "tet:connectivity-matrix/"
+ "tet:underlay/tet:backup-path/tet:path-element/tet:type/"
+ "tet:label/tet:label-hop/tet:te-label/tet:technology" {
when "../../../../../../../../../../../../../../../nw:network-types/"
+ "tet:te-topology/ex-topo:example-topology" {
  description
    "Augmentation parameters apply only for networks with
    example topology type.";
}
case "example" {
  container example {
    description "Attributes for example technology.";
    leaf label-1 {
      type uint32;
      description "Label 1 for example technology.";
    }
  }
}
description "Augment TE label.";
}

augment "/nw:networks/nw:network/nw:node/tet:te/"
+ "tet:te-node-attributes/tet:connectivity-matrices/"
+ "tet:connectivity-matrix/"
+ "tet:path-properties/tet:path-route-objects/"
+ "tet:path-route-object/tet:type/"
+ "tet:label/tet:label-hop/tet:te-label/tet:technology" {
when "../../../../../../../../../../../../../../../nw:network-types/"

```

```
+ "tet:te-topology/ex-topo:example-topology" {
  description
    "Augmentation parameters apply only for networks with
    example topology type.";
}
case "example" {
  container example {
    description "Attributes for example technology.";
    leaf label-1 {
      type uint32;
      description "Label 1 for example technology.";
    }
  }
}
description "Augment TE label.";
}

/* Under information-source-entry/connectivity-matrices */

augment "/nw:networks/nw:network/nw:node/tet:te/"
+ "tet:information-source-entry/tet:connectivity-matrices/"
+ "tet:label-restrictions/tet:label-restriction/tet:label-start/"
+ "tet:te-label/tet:technology" {
when "../../../../../../../nw:network-types/tet:te-topology/"
+ "ex-topo:example-topology" {
  description
    "Augmentation parameters apply only for networks with
    example topology type.";
}
case "example" {
  container example {
    description "Attributes for example technology.";
    leaf label-1 {
      type uint32;
      description "Label 1 for example technology.";
    }
  }
}
description "Augment TE label.";
}
```

```

augment "/nw:networks/nw:network/nw:node/tet:te/"
+ "tet:information-source-entry/tet:connectivity-matrices/"
+ "tet:label-restrictions/tet:label-restriction/tet:label-end/"
+ "tet:te-label/tet:technology" {
when "../../../../../../../../../../../nw:network-types/tet:te-topology/"
+ "ex-topo:example-topology" {
description
  "Augmentation parameters apply only for networks with
  example topology type.";
}
case "example" {
container example {
description "Attributes for example technology.";
leaf label-1 {
type uint32;
description "Label 1 for example technology.";
}
}
}
description "Augment TE label.";
}

augment "/nw:networks/nw:network/nw:node/tet:te/"
+ "tet:information-source-entry/tet:connectivity-matrices/"
+ "tet:underlay/tet:primary-path/tet:path-element/tet:type/"
+ "tet:label/tet:label-hop/tet:te-label/tet:technology" {
when "../../../../../../../../../../../nw:network-types/"
+ "tet:te-topology/ex-topo:example-topology" {
description
  "Augmentation parameters apply only for networks with
  example topology type.";
}
case "example" {
container example {
description "Attributes for example technology.";
leaf label-1 {
type uint32;
description "Label 1 for example technology.";
}
}
}
}

```

```

    description "Augment TE label.";
  }

  augment "/nw:networks/nw:network/nw:node/tet:te/"
    + "tet:information-source-entry/tet:connectivity-matrices/"
    + "tet:underlay/tet:backup-path/tet:path-element/tet:type/"
    + "tet:label/tet:label-hop/tet:te-label/tet:technology" {
    when "../../../../../../../../../../../../../../../nw:network-types/"
      + "tet:te-topology/ex-topo:example-topology" {
      description
        "Augmentation parameters apply only for networks with
        example topology type.";
    }
    case "example" {
      container example {
        description "Attributes for example technology.";
        leaf label-1 {
          type uint32;
          description "Label 1 for example technology.";
        }
      }
    }
  }
  description "Augment TE label.";
}

augment "/nw:networks/nw:network/nw:node/tet:te/"
  + "tet:information-source-entry/tet:connectivity-matrices/"
  + "tet:path-properties/tet:path-route-objects/"
  + "tet:path-route-object/tet:type/"
  + "tet:label/tet:label-hop/tet:te-label/tet:technology" {
  when "../../../../../../../../../../../nw:network-types/"
    + "tet:te-topology/ex-topo:example-topology" {
    description
      "Augmentation parameters apply only for networks with
      example topology type.";
  }
  case "example" {
    container example {
      description "Attributes for example technology.";
      leaf label-1 {
        type uint32;
      }
    }
  }
}

```

```

        description "Label 1 for example technology.";
    }
}
description "Augment TE label.";
}

/* Under information-source-entry/.../connectivity-matrix */

augment "/nw:networks/nw:network/nw:node/tet:te/"
+ "tet:information-source-entry/tet:connectivity-matrices/"
+ "tet:connectivity-matrix/tet:from/"
+ "tet:label-restrictions/tet:label-restriction/tet:label-start/"
+ "tet:te-label/tet:technology" {
when "../../../../../../../../../../../nw:network-types/"
+ "tet:te-topology/ex-topo:example-topology" {
description
    "Augmentation parameters apply only for networks with
    example topology type.";
}
case "example" {
container example {
description "Attributes for example technology.";
leaf label-1 {
type uint32;
description "Label 1 for example technology.";
}
}
}
description "Augment TE label.";
}

augment "/nw:networks/nw:network/nw:node/tet:te/"
+ "tet:information-source-entry/tet:connectivity-matrices/"
+ "tet:connectivity-matrix/tet:from/"
+ "tet:label-restrictions/tet:label-restriction/tet:label-end/"
+ "tet:te-label/tet:technology" {
when "../../../../../../../../../../../nw:network-types/"
+ "tet:te-topology/ex-topo:example-topology" {
description
    "Augmentation parameters apply only for networks with

```



```
        example topology type.";
    }
    case "example" {
        container example {
            description "Attributes for example technology.";
            leaf label-1 {
                type uint32;
                description "Label 1 for example technology.";
            }
        }
    }
    description "Augment TE label.";
}

augment "/nw:networks/nw:network/nw:node/tet:te/"
+ "tet:information-source-entry/tet:connectivity-matrices/"
+ "tet:connectivity-matrix/tet:to/"
+ "tet:label-restrictions/tet:label-restriction/tet:label-start/"
+ "tet:te-label/tet:technology" {
when "../../../nw:network-types/"
+ "tet:te-topology/ex-topo:example-topology" {
    description
        "Augmentation parameters apply only for networks with
        example topology type.";
}
case "example" {
    container example {
        description "Attributes for example technology.";
        leaf label-1 {
            type uint32;
            description "Label 1 for example technology.";
        }
    }
}
description "Augment TE label.";
}

augment "/nw:networks/nw:network/nw:node/tet:te/"
+ "tet:information-source-entry/tet:connectivity-matrices/"
+ "tet:connectivity-matrix/tet:to/"
+ "tet:label-restrictions/tet:label-restriction/tet:label-end/"
```

```
+ "tet:te-label/tet:technology" {
when "../../../../../../../../../../../../../../../nw:network-types/"
+ "tet:te-topology/ex-topo:example-topology" {
  description
    "Augmentation parameters apply only for networks with
    example topology type.";
}
case "example" {
  container example {
    description "Attributes for example technology.";
    leaf label-1 {
      type uint32;
      description "Label 1 for example technology.";
    }
  }
}
description "Augment TE label.";
}

augment "/nw:networks/nw:network/nw:node/tet:te/"
+ "tet:information-source-entry/tet:connectivity-matrices/"
+ "tet:connectivity-matrix/"
+ "tet:underlay/tet:primary-path/tet:path-element/tet:type/"
+ "tet:label/tet:label-hop/tet:te-label/tet:technology" {
when "../../../../../../../../../../../../../../../nw:network-types/"
+ "tet:te-topology/ex-topo:example-topology" {
  description
    "Augmentation parameters apply only for networks with
    example topology type.";
}
case "example" {
  container example {
    description "Attributes for example technology.";
    leaf label-1 {
      type uint32;
      description "Label 1 for example technology.";
    }
  }
}
description "Augment TE label.";
}
```

```

augment "/nw:networks/nw:network/nw:node/tet:te/"
+ "tet:information-source-entry/tet:connectivity-matrices/"
+ "tet:connectivity-matrix/"
+ "tet:underlay/tet:backup-path/tet:path-element/tet:type/"
+ "tet:label/tet:label-hop/tet:te-label/tet:technology" {
when "../../../../../../../../../../../../../../../nw:network-types/"
+ "tet:te-topology/ex-topo:example-topology" {
description
  "Augmentation parameters apply only for networks with
  example topology type.";
}
case "example" {
  container example {
    description "Attributes for example technology.";
    leaf label-1 {
      type uint32;
      description "Label 1 for example technology.";
    }
  }
}
description "Augment TE label.";
}

augment "/nw:networks/nw:network/nw:node/tet:te/"
+ "tet:information-source-entry/tet:connectivity-matrices/"
+ "tet:connectivity-matrix/"
+ "tet:path-properties/tet:path-route-objects/"
+ "tet:path-route-object/tet:type/"
+ "tet:label/tet:label-hop/tet:te-label/tet:technology" {
when "../../../../../../../../../../../../../../../nw:network-types/"
+ "tet:te-topology/ex-topo:example-topology" {
description
  "Augmentation parameters apply only for networks with
  example topology type.";
}
case "example" {
  container example {
    description "Attributes for example technology.";
    leaf label-1 {
      type uint32;

```

```

        description "Label 1 for example technology.";
    }
}
description "Augment TE label.";
}

/* Under tunnel-termination-point/local-link-connectivities */

augment "/nw:networks/nw:network/nw:node/tet:te/"
+ "tet:tunnel-termination-point/tet:local-link-connectivities/"
+ "tet:label-restrictions/tet:label-restriction/tet:label-start/"
+ "tet:te-label/tet:technology" {
when "../../../../../../../../../../../nw:network-types/tet:te-topology/"
+ "ex-topo:example-topology" {
description
    "Augmentation parameters apply only for networks with
    example topology type.";
}
case "example" {
container example {
description "Attributes for example technology.";
leaf label-1 {
type uint32;
description "Label 1 for example technology.";
}
}
}
description "Augment TE label.";
}

augment "/nw:networks/nw:network/nw:node/tet:te/"
+ "tet:tunnel-termination-point/tet:local-link-connectivities/"
+ "tet:label-restrictions/tet:label-restriction/tet:label-end/"
+ "tet:te-label/tet:technology" {
when "../../../../../../../../../../../nw:network-types/tet:te-topology/"
+ "ex-topo:example-topology" {
description
    "Augmentation parameters apply only for networks with
    example topology type.";
}
}

```

```

    case "example" {
      container example {
        description "Attributes for example technology.";
        leaf label-1 {
          type uint32;
          description "Label 1 for example technology.";
        }
      }
    }
    description "Augment TE label.";
  }

  augment "/nw:networks/nw:network/nw:node/tet:te/"
  + "tet:tunnel-termination-point/tet:local-link-connectivities/"
  + "tet:underlay/tet:primary-path/tet:path-element/tet:type/"
  + "tet:label/tet:label-hop/tet:te-label/tet:technology" {
  when "../../../../../../../../../../../../../../../nw:network-types/"
  + "tet:te-topology/ex-topo:example-topology" {
    description
      "Augmentation parameters apply only for networks with
      example topology type.";
  }
  case "example" {
    container example {
      description "Attributes for example technology.";
      leaf label-1 {
        type uint32;
        description "Label 1 for example technology.";
      }
    }
  }
  description "Augment TE label.";
}

  augment "/nw:networks/nw:network/nw:node/tet:te/"
  + "tet:tunnel-termination-point/tet:local-link-connectivities/"
  + "tet:underlay/tet:backup-path/tet:path-element/tet:type/"
  + "tet:label/tet:label-hop/tet:te-label/tet:technology" {
  when "../../../../../../../../../../../../../../../nw:network-types/"
  + "tet:te-topology/ex-topo:example-topology" {
    description

```

```

        "Augmentation parameters apply only for networks with
        example topology type.";
    }
    case "example" {
        container example {
            description "Attributes for example technology.";
            leaf label-1 {
                type uint32;
                description "Label 1 for example technology.";
            }
        }
    }
    description "Augment TE label.";
}

augment "/nw:networks/nw:network/nw:node/tet:te/"
+ "tet:tunnel-termination-point/tet:local-link-connectivities/"
+ "tet:path-properties/tet:path-route-objects/"
+ "tet:path-route-object/tet:type/"
+ "tet:label/tet:label-hop/tet:te-label/tet:technology" {
when "../../../../../../../../../../../../../../../../../../../nw:network-types/"
+ "tet:te-topology/ex-topo:example-topology" {
    description
        "Augmentation parameters apply only for networks with
        example topology type.";
}
case "example" {
    container example {
        description "Attributes for example technology.";
        leaf label-1 {
            type uint32;
            description "Label 1 for example technology.";
        }
    }
}
description "Augment TE label.";
}

/* Under tunnel-termination-point/.../local-link-connectivity */

augment "/nw:networks/nw:network/nw:node/tet:te/"

```

```

+ "tet:tunnel-termination-point/tet:local-link-connectivities/"
+ "tet:local-link-connectivity/"
+ "tet:label-restrictions/tet:label-restriction/tet:label-start/"
+ "tet:te-label/tet:technology" {
when "../../../../../../../../../../../nw:network-types/"
+ "tet:te-topology/ex-topo:example-topology" {
  description
    "Augmentation parameters apply only for networks with
    example topology type.";
}
case "example" {
  container example {
    description "Attributes for example technology.";
    leaf label-1 {
      type uint32;
      description "Label 1 for example technology.";
    }
  }
}
description "Augment TE label.";
}

augment "/nw:networks/nw:network/nw:node/tet:te/"
+ "tet:tunnel-termination-point/tet:local-link-connectivities/"
+ "tet:local-link-connectivity/"
+ "tet:label-restrictions/tet:label-restriction/tet:label-end/"
+ "tet:te-label/tet:technology" {
when "../../../../../../../../../../../nw:network-types/"
+ "tet:te-topology/ex-topo:example-topology" {
  description
    "Augmentation parameters apply only for networks with
    example topology type.";
}
case "example" {
  container example {
    description "Attributes for example technology.";
    leaf label-1 {
      type uint32;
      description "Label 1 for example technology.";
    }
  }
}
}

```

```

    }
    description "Augment TE label.";
  }

  augment "/nw:networks/nw:network/nw:node/tet:te/"
    + "tet:tunnel-termination-point/tet:local-link-connectivities/"
    + "tet:local-link-connectivity/"
    + "tet:underlay/tet:primary-path/tet:path-element/tet:type/"
    + "tet:label/tet:label-hop/tet:te-label/tet:technology" {
  when "../../../nw:network-types/"
    + "tet:te-topology/ex-topo:example-topology" {
    description
      "Augmentation parameters apply only for networks with
      example topology type.";
  }
  case "example" {
    container example {
      description "Attributes for example technology.";
      leaf label-1 {
        type uint32;
        description "Label 1 for example technology.";
      }
    }
  }
  }
  description "Augment TE label.";
}

augment "/nw:networks/nw:network/nw:node/tet:te/"
  + "tet:tunnel-termination-point/tet:local-link-connectivities/"
  + "tet:local-link-connectivity/"
  + "tet:underlay/tet:backup-path/tet:path-element/tet:type/"
  + "tet:label/tet:label-hop/tet:te-label/tet:technology" {
  when "../../../nw:network-types/"
    + "tet:te-topology/ex-topo:example-topology" {
    description
      "Augmentation parameters apply only for networks with
      example topology type.";
  }
  case "example" {
    container example {
      description "Attributes for example technology.";
    }
  }
}

```



```

        leaf label-1 {
            type uint32;
            description "Label 1 for example technology.";
        }
    }
}
description "Augment TE label.";
}

augment "/nw:networks/nw:network/nw:node/tet:te/"
+ "tet:tunnel-termination-point/tet:local-link-connectivities/"
+ "tet:local-link-connectivity/"
+ "tet:path-properties/tet:path-route-objects/"
+ "tet:path-route-object/tet:type/"
+ "tet:label/tet:label-hop/tet:te-label/tet:technology" {
when "../../../nw:network-types/"
+ "tet:te-topology/ex-topo:example-topology" {
    description
        "Augmentation parameters apply only for networks with
        example topology type.";
}
case "example" {
    container example {
        description "Attributes for example technology.";
        leaf label-1 {
            type uint32;
            description "Label 1 for example technology.";
        }
    }
}
description "Augment TE label.";
}

/* Under te-link-attributes */

augment "/nw:networks/nw:network/nt:link/tet:te/"
+ "tet:te-link-attributes/"
+ "tet:label-restrictions/tet:label-restriction/tet:label-start/"
+ "tet:te-label/tet:technology" {
when "../../../nw:network-types/"
+ "tet:te-topology/ex-topo:example-topology" {

```

```

    description
      "Augmentation parameters apply only for networks with
      example topology type.";
  }
  case "example" {
    container example {
      description "Attributes for example technology.";
      leaf label-1 {
        type uint32;
        description "Label 1 for example technology.";
      }
    }
  }
  description "Augment TE label.";
}

augment "/nw:networks/nw:network/nt:link/tet:te/"
+ "tet:te-link-attributes/"
+ "tet:label-restrictions/tet:label-restriction/tet:label-end/"
+ "tet:te-label/tet:technology" {
  when "../../../nw:network-types/"
  + "tet:te-topology/ex-topo:example-topology" {
    description
      "Augmentation parameters apply only for networks with
      example topology type.";
  }
  case "example" {
    container example {
      description "Attributes for example technology.";
      leaf label-1 {
        type uint32;
        description "Label 1 for example technology.";
      }
    }
  }
  description "Augment TE label.";
}

augment "/nw:networks/nw:network/nt:link/tet:te/"
+ "tet:te-link-attributes/"
+ "tet:underlay/tet:primary-path/tet:path-element/tet:type/"

```

```

+ "tet:label/tet:label-hop/tet:te-label/tet:technology" {
when "../../../../../../../../../../../../../../../nw:network-types/"
+ "tet:te-topology/ex-topo:example-topology" {
  description
    "Augmentation parameters apply only for networks with
    example topology type.";
}
case "example" {
  container example {
    description "Attributes for example technology.";
    leaf label-1 {
      type uint32;
      description "Label 1 for example technology.";
    }
  }
}
description "Augment TE label.";
}

augment "/nw:networks/nw:network/nt:link/tet:te/"
+ "tet:te-link-attributes/"
+ "tet:underlay/tet:backup-path/tet:path-element/tet:type/"
+ "tet:label/tet:label-hop/tet:te-label/tet:technology" {
when "../../../../../../../../../../../../../../../nw:network-types/"
+ "tet:te-topology/ex-topo:example-topology" {
  description
    "Augmentation parameters apply only for networks with
    example topology type.";
}
case "example" {
  container example {
    description "Attributes for example technology.";
    leaf label-1 {
      type uint32;
      description "Label 1 for example technology.";
    }
  }
}
description "Augment TE label.";
}

```

```
/* Under te-link information-source-entry */

augment "/nw:networks/nw:network/nt:link/tet:te/"
+ "tet:information-source-entry/"
+ "tet:label-restrictions/tet:label-restriction/tet:label-start/"
+ "tet:te-label/tet:technology" {
when "../../../../../../../nw:network-types/"
+ "tet:te-topology/ex-topo:example-topology" {
description
  "Augmentation parameters apply only for networks with
  example topology type.";
}
case "example" {
container example {
description "Attributes for example technology.";
leaf label-1 {
type uint32;
description "Label 1 for example technology.";
}
}
}
description "Augment TE label.";
}

augment "/nw:networks/nw:network/nt:link/tet:te/"
+ "tet:information-source-entry/"
+ "tet:label-restrictions/tet:label-restriction/tet:label-end/"
+ "tet:te-label/tet:technology" {
when "../../../../../../../nw:network-types/"
+ "tet:te-topology/ex-topo:example-topology" {
description
  "Augmentation parameters apply only for networks with
  example topology type.";
}
case "example" {
container example {
description "Attributes for example technology.";
leaf label-1 {
type uint32;
description "Label 1 for example technology.";
}
}
}
}
```

```
    }  
  }  
  description "Augment TE label."  
}  
}
```

Contributors

Sergio Belotti  
Nokia  
Email: sergio.belotti@nokia.com

Dieter Beller  
Nokia  
Email: Dieter.Beller@nokia.com

Carlo Perocchio  
Ericsson  
Email: carlo.perocchio@ericsson.com

Italo Busi  
Huawei Technologies  
Email: Italo.Busi@huawei.com

Authors' Addresses

Xufeng Liu  
Volta Networks  
Email: xufeng.liu.ietf@gmail.com

Igor Bryskin  
Huawei Technologies  
Email: Igor.Bryskin@huawei.com

Vishnu Pavan Beeram  
Juniper Networks  
Email: vbeeram@juniper.net

Tarek Saad  
Juniper Networks  
Email: tsaad@juniper.net

Himanshu Shah  
Ciena  
Email: hshah@ciena.com

Oscar Gonzalez De Dios  
Telefonica  
Email: oscar.gonzalezdedios@telefonica.com