

Network Working Group
Internet Draft

Y. Lee, Ed.
Huawei Technologies

Intended status: Standard
Expires: October 2012

R. Casellas, Ed.
CTTC

April 30, 2012

PCEP Extension for WSON Routing and Wavelength Assignment

[draft-lee-pce-wson-rwa-ext-04.txt](#)

Abstract

This draft provides the Path Computation Element communication Protocol (PCEP) extensions for the support of Routing and Wavelength Assignment (RWA) in Wavelength Switched Optical Networks (WSON). Lightpath provisioning in WSONs requires a routing and wavelength assignment (RWA) process. From a path computation perspective, wavelength assignment is the process of determining which wavelength can be used on each hop of a path and forms an additional routing constraint to optical light path computation.

Status of this Memo

This Internet-Draft is submitted to IETF in full conformance with the provisions of [BCP 78](#) and [BCP 79](#).

Internet-Drafts are working documents of the Internet Engineering Task Force (IETF), its areas, and its working groups. Note that other groups may also distribute working documents as Internet-Drafts.

Internet-Drafts are draft documents valid for a maximum of six months and may be updated, replaced, or obsoleted by other documents at any time. It is inappropriate to use Internet-Drafts as reference material or to cite them other than as "work in progress."

The list of current Internet-Drafts can be accessed at <http://www.ietf.org/ietf/1id-abstracts.txt>

The list of Internet-Draft Shadow Directories can be accessed at <http://www.ietf.org/shadow.html>.

This Internet-Draft will expire on October 30, 2012.

Copyright Notice

Copyright (c) 2012 IETF Trust and the persons identified as the document authors. All rights reserved.

This document is subject to [BCP 78](#) and the IETF Trust's Legal Provisions Relating to IETF Documents (<http://trustee.ietf.org/license-info>) in effect on the date of publication of this document. Please review these documents carefully, as they describe your rights and restrictions with respect to this document. Code Components extracted from this document must include Simplified BSD License text as described in Section 4.e of the [Trust Legal Provisions](#) and are provided without warranty as described in the Simplified BSD License.

Table of Contents

- [1. Terminology.....3](#)
- [2. Requirements Language.....3](#)
- [3. Introduction.....3](#)
- [4. Encoding of a RWA Path Request.....6](#)
 - [4.1. Wavelength Assignment \(WA\) Object.....6](#)
 - [4.2. Wavelength Restriction Constraint TLV.....8](#)
 - [4.2.1. Link Identifier sub-TLV.....11](#)
 - [4.2.2. Wavelength Restriction Field sub-TLV.....12](#)
 - [4.3. Signal processing capability restrictions.....12](#)
 - [4.3.1. MODULATION-FORMAT-LIST Restriction TLV.....13](#)
 - [4.3.2. FEC-LIST Restriction TLV.....14](#)
 - [4.3.3. Signal Processing Exclusion XRO Sub-Object.....14](#)
 - [4.3.4. IRO sub-object: signal processing inclusion.....14](#)
- [5. Encoding of a RWA Path Reply.....15](#)
 - [5.1. Error Indicator.....15](#)
 - [5.2. NO-PATH Indicator.....16](#)
- [6. Manageability Considerations.....16](#)
 - [6.1. Control of Function and Policy.....16](#)
 - [6.2. Information and Data Models, e.g. MIB module.....17](#)
 - [6.3. Liveness Detection and Monitoring.....17](#)
 - [6.4. Verifying Correct Operation.....17](#)
 - [6.5. Requirements on Other Protocols and Functional Components17](#)

6.6. Impact on Network Operation.....	17
7. Security Considerations.....	17
8. IANA Considerations.....	18
9. Acknowledgments.....	18
10. References.....	18
10.1. Informative References.....	18
11. Contributors.....	20
Authors' Addresses.....	21
Intellectual Property Statement.....	21
Disclaimer of Validity.....	22

[1. Terminology](#)

This document uses the terminology defined in [[RFC4655](#)], and [[RFC5440](#)].

[2. Requirements Language](#)

The key words "MUST", "MUST NOT", "REQUIRED", "SHALL", "SHALL NOT", "SHOULD", "SHOULD NOT", "RECOMMENDED", "MAY", and "OPTIONAL" in this document are to be interpreted as described in [[RFC2119](#)].

[3. Introduction](#)

[[RFC4655](#)] defines the PCE based Architecture and explains how a Path Computation Element (PCE) may compute Label Switched Paths (LSP) in Multiprotocol Label Switching Traffic Engineering (MPLS-TE) and Generalized MPLS (GMPLS) networks at the request of Path Computation Clients (PCCs). A PCC is said to be any network component that makes such a request and may be, for instance, an Optical Switching Element within a Wavelength Division Multiplexing (WDM) network. The PCE, itself, can be located anywhere within the network, and may be within an optical switching element, a Network Management System (NMS) or Operational Support System (OSS), or may be an independent network server.

The PCE communications Protocol (PCEP) is the communication protocol used between PCC and PCE, and may also be used between cooperating PCEs. [[RFC4657](#)] sets out the common protocol requirements for PCEP. Additional application-specific requirements for PCEP are deferred to separate documents.

This document provides the PCEP extensions for the support of Routing and Wavelength Assignment (RWA) in Wavelength Switched Optical Networks (WSON) based on the requirements specified in [PCE-RWA].

WSON refers to WDM based optical networks in which switching is performed selectively based on the wavelength of an optical signal. In this document, it is assumed that wavelength converters require electrical signal regeneration. Consequently, WSONs can be transparent (A transparent optical network is made up of optical devices that can switch but not convert from one wavelength to another, all within the optical domain) or translucent (3R regenerators are sparsely placed in the network).

A LSC Label Switched Path (LSP) may span one or several transparent segments, which are delimited by 3R regenerators (typically with electronic regenerator and optional wavelength conversion). Each transparent segment or path in WSON is referred to as an optical path. An optical path may span multiple fiber links and the path should be assigned the same wavelength for each link. In such case, the optical path is said to satisfy the wavelength-continuity constraint. Figure 1 illustrates the relationship between a LSC LSP and transparent segments (optical paths).

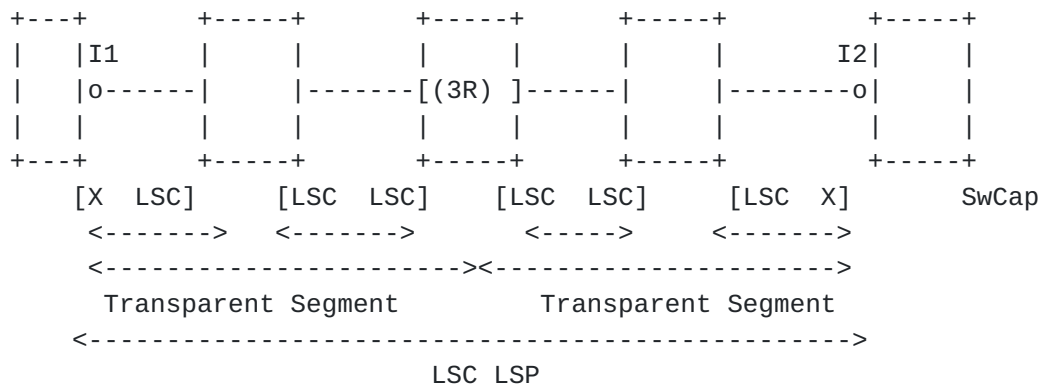

Figure 1 Illustration of a LSC LSP and transparent segments

Note that two optical paths within a WSON LSP need not operate on the same wavelength (due to the wavelength conversion capabilities). Two optical paths that share a common fiber link cannot be assigned the same wavelength. To do otherwise would result in both signals interfering with each other. Note that advanced additional multiplexing techniques such as polarization based multiplexing are

not addressed in this document since the physical layer aspects are not currently standardized. Therefore, assigning the proper wavelength on a lightpath is an essential requirement in the optical path computation process.

When a switching node has the ability to perform wavelength conversion, the wavelength-continuity constraint can be relaxed, and a LSC Label Switched Path (LSP) may use different wavelengths on different links along its route from origin to destination. It is, however, to be noted that wavelength converters may be limited due to their relatively high cost, while the number of WDM channels that can be supported in a fiber is also limited. As a WSON can be composed of network nodes that cannot perform wavelength conversion, nodes with limited wavelength conversion, and nodes with full wavelength conversion abilities, wavelength assignment is an additional routing constraint to be considered in all lightpath computation.

For example, within a translucent WSON, a LSC LSP may be established between interfaces I1 and I2, spanning 2 transparent segments (optical paths) where the wavelength continuity constraint applies (i.e. the same unique wavelength MUST be assigned to the LSP at each TE link of the segment). If the LSC LSP induced a Forwarding Adjacency / TE link, the switching capabilities of the TE link would be [X X] where $X < \text{LSC}$ (PSC, TDM, ...).

[Ed note: in general, WSON LSC may not be the only switching layer with switching constraints. From a GMPLS/PCEP perspective, wavelength assignment corresponds to label allocation. This document should align with GMPLS extensions for PCEP. Wavelength restrictions and constraints should be formulated in terms of labels (i.e. LABEL_SET, SUGGESTED_LABEL, UPSTREAM_LABEL, etc.)]

The optical modulation properties, which are also referred to as signal compatibility, are already considered in signaling in [RWA-Encode] and [[WSON-OSPF](#)]. In order to improve the signal quality and limit some optical effects several advanced modulation processing are used. Those modulation properties contribute not only to optical signal quality checks but also constrain the selection of sender and receiver, as they should have matching signal processing capabilities. This document includes signal compatibility constraint as part of RWA path computation. That is, the signal processing capabilities (e.g., modulation and FEC) must be compatible between the sender and the receiver of the optical path across all optical elements.

This document, however, does not address optical impairments as part of RWA path computation. See [WSON-Imp] and [RSVP-Imp] for more information on optical impairments and GMPLS.

4. Encoding of a RWA Path Request

Figure 2 shows one typical PCE based implementation, which is referred to as Combined Process (R&WA). With this architecture, the two processes of routing and wavelength assignment are accessed via a single PCE. This architecture is the base architecture from which the requirements have been specified in [PCE-RWA] and the PCEP extensions that are going to be specified in this document based on this architecture.

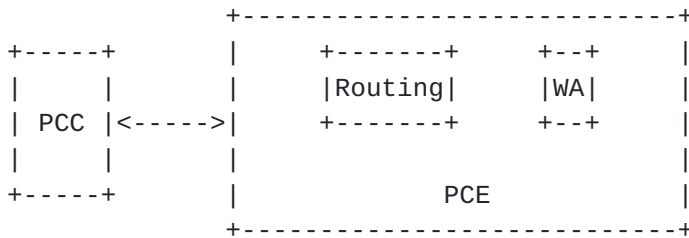

Figure 2 Combined Process (R&WA) architecture

4.1. Wavelength Assignment (WA) Object

The current RP object is used to indicate routing related information in a new path request per [RFC5440]. Since a new RWA path request involves both routing and wavelength assignment, the wavelength assignment related information in the request SHOULD be coupled in the path request.

Wavelength allocation can be performed by the PCE by different means:

- (a) By means of Explicit Label Control, in the sense that one (or two) allocated labels MAY appear after an interface route subobject.
- (b) By means of a Label Set, containing one or more allocated Labels, provided by the PCE.

Option (b) allows distributed label allocation (performed during signaling) to complete wavelength assignment.

Additionally, given a range of potential labels to allocate, the request SHOULD convey the heuristic / mechanism to the allocation.

The format of a PCReq message after incorporating the WA object is as follows:

```

<PCReq Message> ::= <Common Header>
                    [<svec-list>]
                    <request-list>

```

Where:

```

<request-list> ::= <request> [<request-list>]
<request> ::= <RP>
              <ENDPOINTS>
              <WA>
              [other optional objects...]

```

If WA object is present in the request, the WA object MUST be encoded after the ENDPOINTS object.

The format of the Wavelength Assignment (WA) object body is as follows:

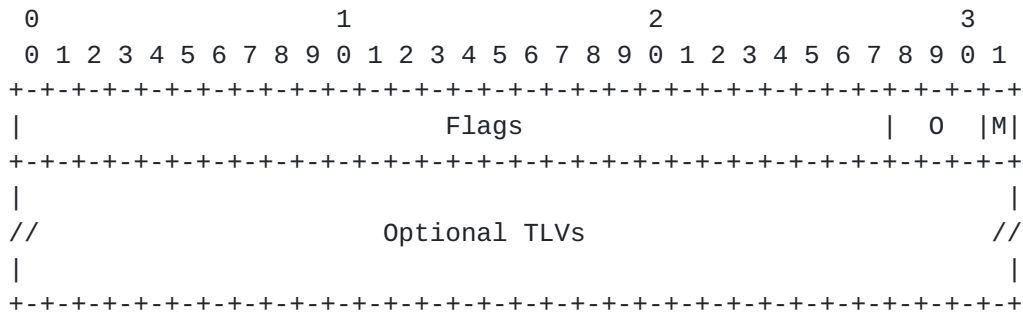

Figure 3 WA Object

- o Flags (32 bits)

The following new flags SHOULD be set

- . M (Mode - 1 bit): M bit is used to indicate the mode of wavelength assignment. When M bit is set to 1, this indicates that the label assigned by the PCE must be explicit. That is, the selected way to convey the allocated wavelength is by means of Explicit Label Control (ELC) [[RFC4003](#)] for each hop of a computed LSP. Otherwise, the label assigned by the PCE needs not be explicit (i.e., it can be suggested in the form of label set objects in the corresponding response, to allow distributed WA. In such case, the PCE MUST return a Label_Set object in the response if the path is found.

When the distributed WA is applied, some specific wavelength range and/or the maximum number of wavelengths to be returned in the Label Set might be additionally indicated. The optional TLV field will be used for conveying this additional request. The details of this encoding will be provided in a later revision.

- . O (Order - 3 bits): O bit is used to indicate the wavelength assignment constraint in regard to the order of wavelength assignment to be returned by the PCE. This case is only applied when M bit is set to "explicit." The following indicators should be defined:

- 000 - Reserved
- 001 - Random Assignment
- 010 - First Fit (FF) in descending Order
- 011 - First Fit (FF) in ascending Order
- 100 - Last Fit (LF) in ascending Order
- 101 - Last Fit (LF) in descending Order
- 110 - Unspecified
- 111 - Reserved

4.2. Wavelength Restriction Constraint TLV

For any request that contains a wavelength assignment, the requester (PCC) MUST be able to specify a restriction on the wavelengths to be used. This restriction is to be interpreted by the PCE as a constraint on the tuning ability of the origination laser transmitter or on any other maintenance related constraints. Note that if the LSP LSC spans different segments, the PCE MUST have

mechanisms to know the tunability restrictions of the involved wavelength converters / regenerators, e.g. by means of the TED either via IGP or NMS. Even if the PCE knows the tunability of the transmitter, the PCC MUST be able to apply additional constraints to the request.

[Ed note: Which PCEP Object will home this TLV is yet to be determined. Since this involves the end-point, The END-POINTS Object might be a good candidate to encode this TLV, which will be provided in a later revision.]

[Ed note: The current encoding assumes that tunability restriction applied to link-level.]

The TLV type is TBD, recommended value is TBD. This TLV MAY appear more than once to be able to specify multiple restrictions.

The TLV data is defined as follows:

<Wavelength Restriction Constraint> ::=
 <Action> <Format> <Reserved>
 (<Link Identifiers> <Wavelength Restriction>)...

Where

<Link Identifiers> ::=
 <Unnumbered IF ID> | <IPV4 Address> | <IPV6 Address>

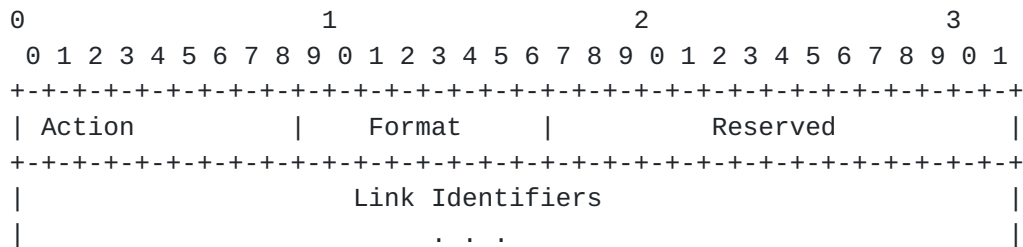

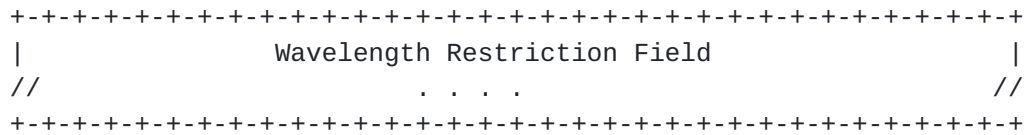

Figure 4 Wavelength Restriction

o Action: 8 bits

- . 0 - Inclusive List indicates that one or more link identifiers are included in the Link Set. Each identifies a separate link that is part of the set.
- . 1 - Inclusive Range indicates that the Link Set defines a range of links. It contains two link identifiers. The first identifier indicates the start of the range (inclusive). The second identifier indicates the end of the range (inclusive). All links with numeric values between the bounds are considered to be part of the set. A value of zero in either position indicates that there is no bound on the corresponding portion of the range. Note that the Action field can be set to 0 when unnumbered link identifier is used.

Note that "interfaces" such as those discussed in the Interfaces MIB [[RFC2863](#)] are assumed to be bidirectional.

o Format: The format of the link identifier (8 bits)

- . 0 -- Unnumbered Link Identifier
- . 1 -- Local Interface IPv4 Address
- . 2 -- Local Interface IPv6 Address
- . Others TBD.

Note that all link identifiers in the same list must be of the same type.

o Reserved: Reserved for future use (16 bits)

o Link Identifiers: Identifies each link ID for which restriction is applied. The length is dependent on the link format. See the following section for Link Identifier encoding.

4.2.1. Link Identifier sub-TLV

The link identifier field can be an IPv4, IPv6 or unnumbered interface ID.

<Link Identifier> ::=

<IPv4 Address> | <IPv6 Address> | <Unnumbered IF ID>

The encoding of each case is as follows:

IPv4 prefix Sub-TLV

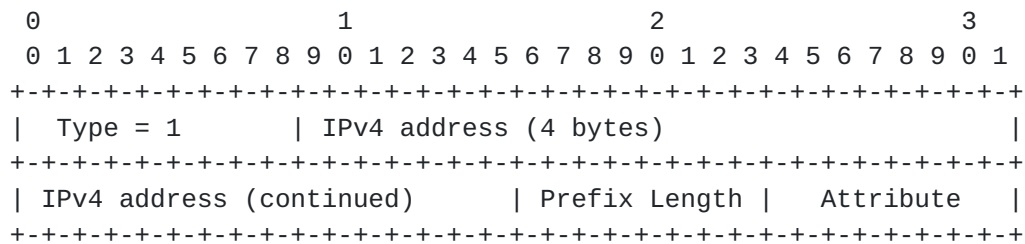

IPv6 prefix Sub-TLV



Unnumbered Interface ID Sub-TLV

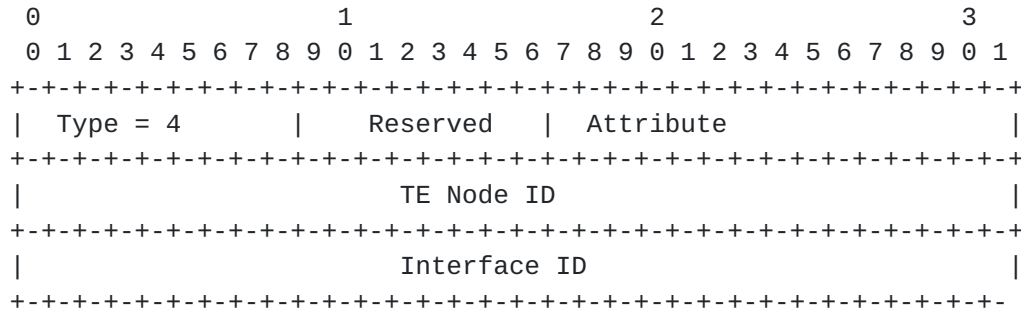

4.2.2. Wavelength Restriction Field sub-TLV

The Wavelength Restriction Field of the wavelength restriction TLV is encoded as a Label Set field as specified in [GEN-Encode] section 2.2, as shown below, with base label encoded as a 32 bit LSC label, defined in [RFC6205]. See [RFC6205] for a description of Grid, C.S, Identifier and n, as well as [GEN-Encode] for the details of each action.

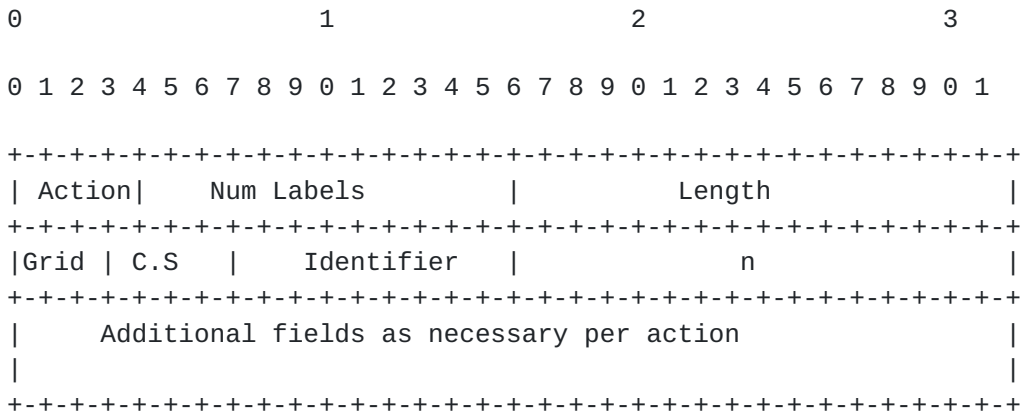

4.3. Signal processing capability restrictions

Path computation for WSON include the check of signal processing capabilities, those capability MAY be provided by the IGP, however this is not a MUST. Moreover, a PCC should be able to indicate additional restrictions for those signal compatibility, either on the endpoint or any given link.

The supported signal processing capabilities are the one described in [[RWA-Info](#)]:

- . Modulation Type List
- . FEC Type List
- . Bit rate
- . Client signal

The Bit-rate restriction is already expressed in [[PCEP-GMPLS](#)] in the GENERALIZED-BANDWIDTH object.

The client signal information can be expressed using the REQ-ADAP-CAP object from the [[PCEP-Layer](#)].

In order to support the Modulation and FEC information two new TLV are introduced as endpoint-restriction in the END-POINTS type Generalized endpoint:

- . Modulation restriction TLV
- . FEC restriction TLV.

The END-POINTS type generalized endpoint is extended as follow:

```
<endpoint-restrictions> ::= <LABEL-REQUEST>
                                <label-restriction-list>
                                [<signal-compatibility-restriction>...]
```

Where

```
signal-compatibility-restriction ::=
    <MODULATION-FORMAT-LIST>|<FEC-LIST>
```

The MODULATION-FORMAT-LIST and FEC-LIST TLV are described in the following sections.

4.3.1. MODULATION-FORMAT-LIST Restriction TLV

The format follows the definition from [[WSON-Encode](#)] [section 5.2](#).

4.3.2. FEC-LIST Restriction TLV

The format follows the definition from [WSON-Encode] [section 5.3](#).

4.3.3. Signal Processing Exclusion XRO Sub-Object

The PCC/PCE should be able to exclude particular types of signal processing along the path in order to handle client restriction or multi-domain path computation.

In order to support the exclusion a new XRO sub-object is defined: the signal processing exclusion:

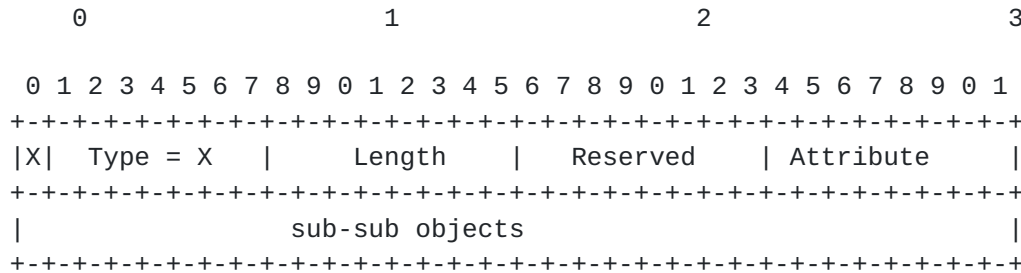

Figure 5 Signaling Processing XRO Sub-Object

The Attribute field indicates how the exclusion sub-object is to be interpreted. The Attribute can only be 0 (Interface) or 1 (Node).

The sub-sub objects are encoded as in RSVP signaling definition [[WSON-Sign](#)].

4.3.4. IRO sub-object: signal processing inclusion

Similar to the XRO sub-object the PCC/PCE should be able to include particular types of signal processing along the path in order to handle client restriction or multi-domain path computation.

This is supported by adding the sub-object "processing" defined for ERO in [[WSON-Sign](#)] to the PCEP IRO object.

5. Encoding of a RWA Path Reply

The ERO is used to encode the path of a TE LSP through the network. The ERO is carried within a given path of a PCEP response, which is in turn carried in a PCRep message to provide the computed TE LSP if the path computation was successful. The preferred way to convey the allocated wavelength is by means of Explicit Label Control (ELC) [[RFC4003](#)].

In order to encode wavelength assignment, the Wavelength Assignment (WA) Object needs to be employed to be able to specify wavelength assignment. Since each segment of the computed optical path is associated with wavelength assignment, the WA Object should be aligned with the ERO object.

Encoding details will be provided further revisions and will be aligned as much as possible with [[WSON-Sign](#)].

5.1. Error Indicator

To indicate errors associated with the RWA request, a new Error Type (TDB) and subsequent error-values are defined as follows for inclusion in the PCEP-ERROR Object:

A new Error-Type (TDB) and subsequent error-values are defined as follows:

- . Error-Type=TBD; Error-value=1: if a PCE receives a RWA request and the PCE is not capable of processing the request due to insufficient memory, the PCE MUST send a PCErr message with a PCEP-ERROR Object (Error-Type=TDB) and an Error-value(Error-value=1). The PCE stops processing the request. The corresponding RWA request MUST be cancelled at the PCC.
- . Error-Type=TBD; Error-value=2: if a PCE receives a RWA request and the PCE is not capable of RWA computation, the PCE MUST send a PCErr message with a PCEP-ERROR Object (Error-Type=15) and an Error-value (Error-value=2). The PCE stops processing the request. The corresponding RWA computation MUST be cancelled at the PCC.

5.2. NO-PATH Indicator

To communicate the reason(s) for not being able to find RWA for the path request, the NO-PATH object can be used in the PCRep message. The format of the NO-PATH object body is defined in [[RFC5440](#)]. The object may contain a NO-PATH-VECTOR TLV to provide additional information about why a path computation has failed.

Two new bit flags are defined to be carried in the Flags field in the NO-PATH-VECTOR TLV carried in the NO-PATH Object.

- . Bit TDB: When set, the PCE indicates no feasible route was found that meets all the constraints associated with RWA.
- . Bit TDB: When set, the PCE indicates that no wavelength was assigned to at least one hop of the route in the response.
- . Bit TDB: When set, the PCE indicate that no path was found satisfying the signal compatibility constraints.

6. Manageability Considerations

Manageability of WSON Routing and Wavelength Assignment (RWA) with PCE must address the following considerations:

6.1. Control of Function and Policy

In addition to the parameters already listed in [Section 8.1](#) of [PCEP], a PCEP implementation SHOULD allow configuring the following PCEP session parameters on a PCC:

- . The ability to send a WSON RWA request.

In addition to the parameters already listed in [Section 8.1](#) of [PCEP], a PCEP implementation SHOULD allow configuring the following PCEP session parameters on a PCE:

- . The support for WSON RWA.
- . A set of WSON RWA specific policies (authorized sender, request rate limiter, etc).

These parameters may be configured as default parameters for any PCEP session the PCEP speaker participates in, or may apply to a specific session with a given PCEP peer or a specific group of sessions with a specific group of PCEP peers.

6.2. Information and Data Models, e.g. MIB module

Extensions to the PCEP MIB module defined in [PCEP-MIB] should be defined, so as to cover the WSON RWA information introduced in this document. A future revision of this document will list the information that should be added to the MIB module.

6.3. Liveness Detection and Monitoring

Mechanisms defined in this document do not imply any new liveness detection and monitoring requirements in addition to those already listed in [section 8.3 of \[RFC5440\]](#).

6.4. Verifying Correct Operation

Mechanisms defined in this document do not imply any new verification requirements in addition to those already listed in [section 8.4 of \[RFC5440\]](#)

6.5. Requirements on Other Protocols and Functional Components

The PCE Discovery mechanisms ([\[RFC5089\]](#) and [\[RFC5088\]](#)) may be used to advertise WSON RWA path computation capabilities to PCCs.

6.6. Impact on Network Operation

Mechanisms defined in this document do not imply any new network operation requirements in addition to those already listed in [section 8.6 of \[RFC5440\]](#).

7. Security Considerations

This document has no requirement for a change to the security models within PCEP [PCEP]. However the additional information distributed in order to address the RWA problem represents a disclosure of

network capabilities that an operator may wish to keep private. Consideration should be given to securing this information.

8. IANA Considerations

A future revision of this document will present requests to IANA for codepoint allocation.

9. Acknowledgments

The authors would like to thank Adrian Farrel for many helpful comments that greatly improved the contents of this draft.

This document was prepared using 2-Word-v2.0.template.dot.

10. References

10.1. Informative References

- [RFC2119] Bradner, S., "Key words for use in RFCs to Indicate Requirement Levels", [BCP 14](#), [RFC 2119](#), March 1997.
- [RFC3471] Berger, L., "Generalized Multi-Protocol Label Switching (GMPLS) Signaling Functional Description", [RFC 3471](#), January 2003.
- [RFC3473] Berger, L., Ed., "Generalized Multi-Protocol Label Switching (GMPLS) Signaling Resource Reservation Protocol-Traffic Engineering (RSVP-TE) Extensions", [RFC 3473](#), January 2003.
- [RFC3477] Kompella, K. and Y. Rekhter, "Signalling Unnumbered Links in Resource ReSerVation Protocol - Traffic Engineering (RSVP-TE)", [RFC 3477](#), January 2003.
- [RFC4003] Berger, L., "GMPLS Signaling Procedure for Egress Control", [RFC 4003](#), February 2005.
- [RFC4655] Farrel, A., Vasseur, J., and J. Ash, "A Path Computation Element (PCE)-Based Architecture", [RFC 4655](#), August 2006.

- [RFC4657] Ash, J. and J. Le Roux, "Path Computation Element (PCE) Communication Protocol Generic Requirements", [RFC 4657](#), September 2006.
- [RFC5440] Vasseur, JP., Ed. and JL. Le Roux, Ed., "Path Computation Element (PCE) communication Protocol", [RFC 5440](#), March 2009.
- [PCEP-GMPLS] Margaria, et al., "PCEP extensions for GMPLS", [draft-ietf-pce-gmpls-pcep-extensions](#), work in progress.
- [PCEP-Layer] Oki, Takeda, Le Roux, and Farrel, "Extensions to the Path Computation Element communication Protocol (PCEP) for Inter-Layer MPLS and GMPLS Traffic Engineering", [draft-ietf-pce-inter-layer-ext](#), work in progress.
- [RFC6163] Lee, Y. and Bernstein, G. (Editors), and W. Imajuku, "Framework for GMPLS and PCE Control of Wavelength Switched Optical Networks", [RFC 6163](#), March 2011.
- [PCE-RWA] Lee, Y., et. al., "PCEP Requirements for WSON Routing and Wavelength Assignment", [draft-ietf-pce-wson-routing-wavelength](#), work in progress.
- [RFC6205] Tomohiro, O. and D. Li, "Generalized Labels for Lambda-Switching Capable Label Switching Routers", [RFC 6205](#), January, 2011.
- [WSON-Sign] Bernstein et al, "Signaling Extensions for Wavelength Switched Optical Networks", [draft-ietf-ccamp-wson-signaling](#), work in progress.
- [WSON-OSPF] Lee and Bernstein, "OSPF Enhancement for Signal and Network Element Compatibility for Wavelength Switched Optical Networks", [draft-ietf-ccamp-wson-signal-compatibility-ospf](#), work in progress.
- [RWA-Info] Bernstein and Lee, "Routing and Wavelength Assignment Information Model for Wavelength Switched Optical Networks", [draft-ietf-ccamp-rwa-info](#), work in progress.
- [RWA-Encode] Bernstein and Lee, "Routing and Wavelength Assignment Information Encoding for Wavelength Switched Optical Networks", [draft-ietf-ccamp-rwa-wson-encode](#), work in progress.

- [GEN-Encode] Bernstein and Lee, "General Network Element Constraint Encoding for GMPLS Controlled Networks", [draft-ietf-ccamp-general-constraint-encode](#), work in progress.
- [WSON-Imp] Y. Lee, G. Bernstein, D. Li, G. Martinelli, "A Framework for the Control of Wavelength Switched Optical Networks (WSON) with Impairments", [draft-ietf-ccamp-wson-impairments](#), work in progress.
- [RSVP-Imp] agraz, "RSVP-TE Extensions in Support of Impairment Aware Routing and Wavelength Assignment in Wavelength Switched Optical Networks (WSONs)", [draft-agraz-ccamp-wson-impairment-rsvp](#), work in progress.
- [OSPF-Imp] Bellagamba, et al., "OSPF Extensions for Wavelength Switched Optical Networks (WSON) with Impairments", [draft-eb-ccamp-ospf-wson-impairments](#), work in progress.

11. Contributors

Authors' Addresses

Young Lee, Editor
Huawei Technologies
1700 Alma Drive, Suite 100
Plano, TX 75075, USA
Phone: (972) 509-5599 (x2240)
Email: leeyoung@huawei.com

Ramon Casellas, Editor
CTTC PMT Ed B4 Av. Carl Friedrich Gauss 7
08860 Castelldefels (Barcelona)
Spain
Phone: (34) 936452916
Email: ramon.casellas@cttc.es

Fatai Zhang
Huawei Technologies
Email: zhangfatai@huawei.com

Cyril Margaria
Nokia Siemens Networks
St Martin Strasse 76
Munich, 81541
Germany
Phone: +49 89 5159 16934
Email: cyril.margaria@nsn.com

Oscar Gonzalez de Dios
Telefonica Investigacion y Desarrollo
C/ Emilio Vargas 6
Madrid, 28043
Spain
Phone: +34 91 3374013
Email: ogondio@tid.es

Greg Bernstein
Grotto Networking
Fremont, CA, USA
Phone: (510) 573-2237
Email: gregb@grotto-networking.com

Intellectual Property Statement

The IETF Trust takes no position regarding the validity or scope of any Intellectual Property Rights or other rights that might be claimed to pertain to the implementation or use of the technology described in any IETF Document or the extent to which any license under such rights might or might not be available; nor does it represent that it has made any independent effort to identify any such rights.

Copies of Intellectual Property disclosures made to the IETF Secretariat and any assurances of licenses to be made available, or the result of an attempt made to obtain a general license or permission for the use of such proprietary rights by implementers or users of this specification can be obtained from the IETF on-line IPR repository at <http://www.ietf.org/ipr>

The IETF invites any interested party to bring to its attention any copyrights, patents or patent applications, or other proprietary rights that may cover technology that may be required to implement any standard or specification contained in an IETF Document. Please address the information to the IETF at ietf-ipr@ietf.org.

Disclaimer of Validity

All IETF Documents and the information contained therein are provided on an "AS IS" basis and THE CONTRIBUTOR, THE ORGANIZATION HE/SHE REPRESENTS OR IS SPONSORED BY (IF ANY), THE INTERNET SOCIETY, THE IETF TRUST AND THE INTERNET ENGINEERING TASK FORCE DISCLAIM ALL WARRANTIES, EXPRESS OR IMPLIED, INCLUDING BUT NOT LIMITED TO ANY WARRANTY THAT THE USE OF THE INFORMATION THEREIN WILL NOT INFRINGE ANY RIGHTS OR ANY IMPLIED WARRANTIES OF MERCHANTABILITY OR FITNESS FOR A PARTICULAR PURPOSE.

Acknowledgment

Funding for the RFC Editor function is currently provided by the Internet Society.