

Network Working Group

Internet-Draft

Updates: [rfc1191](#), [rfc4193](#), [rfc4291](#),  
[rfc4443](#), [rfc8201](#) (if approved)

Intended status: Standards Track

Expires: April 4, 2021

F. Templin, Ed.

The Boeing Company

A. Whyman

MWA Ltd c/o Inmarsat Global Ltd

October 1, 2020

**Transmission of IP Packets over Overlay Multilink Network (OMNI)  
Interfaces  
draft-templin-6man-omni-interface-42**

Abstract

Mobile nodes (e.g., aircraft of various configurations, terrestrial vehicles, seagoing vessels, enterprise wireless devices, etc.) communicate with networked correspondents over multiple access network data links and configure mobile routers to connect end user networks. A multilink interface specification is therefore needed for coordination with the network-based mobility service. This document specifies the transmission of IP packets over Overlay Multilink Network (OMNI) Interfaces.

Status of This Memo

This Internet-Draft is submitted in full conformance with the provisions of [BCP 78](#) and [BCP 79](#).

Internet-Drafts are working documents of the Internet Engineering Task Force (IETF). Note that other groups may also distribute working documents as Internet-Drafts. The list of current Internet-Drafts is at <https://datatracker.ietf.org/drafts/current/>.

Internet-Drafts are draft documents valid for a maximum of six months and may be updated, replaced, or obsoleted by other documents at any time. It is inappropriate to use Internet-Drafts as reference material or to cite them other than as "work in progress."

This Internet-Draft will expire on April 4, 2021.

Copyright Notice

Copyright (c) 2020 IETF Trust and the persons identified as the document authors. All rights reserved.

This document is subject to [BCP 78](#) and the IETF Trust's Legal Provisions Relating to IETF Documents (<https://trustee.ietf.org/license-info>) in effect on the date of

publication of this document. Please review these documents carefully, as they describe your rights and restrictions with respect to this document. Code Components extracted from this document must include Simplified BSD License text as described in Section 4.e of the Trust Legal Provisions and are provided without warranty as described in the Simplified BSD License.

## Table of Contents

<a href="#">1.</a>	<a href="#">Introduction</a>	<a href="#">3</a>
<a href="#">2.</a>	<a href="#">Terminology</a>	<a href="#">4</a>
<a href="#">3.</a>	<a href="#">Requirements</a>	<a href="#">7</a>
<a href="#">4.</a>	<a href="#">Overlay Multilink Network (OMNI) Interface Model</a>	<a href="#">8</a>
<a href="#">5.</a>	<a href="#">The OMNI Adaptation Layer (OAL)</a>	<a href="#">11</a>
<a href="#">5.1.</a>	<a href="#">Fragmentation Security Implications</a>	<a href="#">14</a>
<a href="#">6.</a>	<a href="#">Frame Format</a>	<a href="#">15</a>
<a href="#">7.</a>	<a href="#">Link-Local Addresses (LLAs)</a>	<a href="#">15</a>
<a href="#">8.</a>	<a href="#">Unique-Local Addresses (ULAs)</a>	<a href="#">16</a>
<a href="#">9.</a>	<a href="#">Address Mapping - Unicast</a>	<a href="#">18</a>
<a href="#">9.1.</a>	<a href="#">Sub-Options</a>	<a href="#">19</a>
<a href="#">9.1.1.</a>	<a href="#">Pad1</a>	<a href="#">20</a>
<a href="#">9.1.2.</a>	<a href="#">PadN</a>	<a href="#">21</a>
<a href="#">9.1.3.</a>	<a href="#">Interface Attributes</a>	<a href="#">21</a>
<a href="#">9.1.4.</a>	<a href="#">Traffic Selector</a>	<a href="#">25</a>
<a href="#">9.1.5.</a>	<a href="#">MS-Register</a>	<a href="#">25</a>
<a href="#">9.1.6.</a>	<a href="#">MS-Release</a>	<a href="#">26</a>
<a href="#">9.1.7.</a>	<a href="#">Network Access Identifier (NAI)</a>	<a href="#">26</a>
<a href="#">9.1.8.</a>	<a href="#">Geo Coordinates</a>	<a href="#">27</a>
<a href="#">9.1.9.</a>	<a href="#">DHCP Unique Identifier (DUID)</a>	<a href="#">27</a>
<a href="#">10.</a>	<a href="#">Address Mapping - Multicast</a>	<a href="#">28</a>
<a href="#">11.</a>	<a href="#">Conceptual Sending Algorithm</a>	<a href="#">28</a>
<a href="#">11.1.</a>	<a href="#">Multiple OMNI Interfaces</a>	<a href="#">29</a>
<a href="#">12.</a>	<a href="#">Router Discovery and Prefix Registration</a>	<a href="#">29</a>
12.1.	<a href="#">Router Discovery in IP Multihop and IPv4-Only Access Networks</a>	<a href="#">33</a>
<a href="#">12.2.</a>	<a href="#">MS-Register and MS-Release List Processing</a>	<a href="#">34</a>
<a href="#">13.</a>	<a href="#">Secure Redirection</a>	<a href="#">36</a>
<a href="#">14.</a>	<a href="#">AR and MSE Resilience</a>	<a href="#">36</a>
<a href="#">15.</a>	<a href="#">Detecting and Responding to MSE Failures</a>	<a href="#">37</a>
<a href="#">16.</a>	<a href="#">Transition Considerations</a>	<a href="#">37</a>
<a href="#">17.</a>	<a href="#">OMNI Interfaces on the Open Internet</a>	<a href="#">38</a>
<a href="#">18.</a>	<a href="#">Time-Varying MNPs</a>	<a href="#">39</a>
<a href="#">19.</a>	<a href="#">IANA Considerations</a>	<a href="#">40</a>
<a href="#">20.</a>	<a href="#">Security Considerations</a>	<a href="#">41</a>
<a href="#">21.</a>	<a href="#">Implementation Status</a>	<a href="#">41</a>
<a href="#">22.</a>	<a href="#">Acknowledgements</a>	<a href="#">42</a>
<a href="#">23.</a>	<a href="#">References</a>	<a href="#">42</a>
<a href="#">23.1.</a>	<a href="#">Normative References</a>	<a href="#">42</a>



[23.2](#). Informative References . . . . . [44](#)  
[Appendix A](#). Interface Attribute Heuristic Bitmap Encoding . . . . . [48](#)  
[Appendix B](#). VDL Mode 2 Considerations . . . . . [50](#)  
[Appendix C](#). MN / AR Isolation Through L2 Address Mapping . . . . . [51](#)  
[Appendix D](#). Change Log . . . . . [52](#)  
 Authors' Addresses . . . . . [54](#)

**1. Introduction**

Mobile Nodes (MNs) (e.g., aircraft of various configurations, terrestrial vehicles, seagoing vessels, enterprise wireless devices, etc.) often have multiple data links for communicating with networked correspondents. These data links may have diverse performance, cost and availability properties that can change dynamically according to mobility patterns, flight phases, proximity to infrastructure, etc. MNs coordinate their data links in a discipline known as "multilink", in which a single virtual interface is configured over the underlying data links.

The MN configures a virtual interface (termed the "Overlay Multilink Network (OMNI) interface") as a thin layer over the underlying Access Network (ANET) interfaces. The OMNI interface is therefore the only interface abstraction exposed to the IP layer and behaves according to the Non-Broadcast, Multiple Access (NBMA) interface principle, while underlying interfaces appear as link layer communication channels in the architecture. The OMNI interface connects to a virtual overlay service known as the "OMNI link". The OMNI link spans one or more Internetworks that may include private-use infrastructures and/or the global public Internet itself.

Each MN receives a Mobile Network Prefix (MNP) for numbering downstream-attached End User Networks (EUNs) independently of the access network data links selected for data transport. The MN performs router discovery over the OMNI interface (i.e., similar to IPv6 customer edge routers [[RFC7084](#)]) and acts as a mobile router on behalf of its EUNs. The router discovery process is iterated over each of the OMNI interface's underlying interfaces in order to register per-link parameters (see [Section 12](#)).

The OMNI interface provides a multilink nexus for exchanging inbound and outbound traffic via the correct underlying interface(s). The IP layer sees the OMNI interface as a point of connection to the OMNI link. Each OMNI link has one or more associated Mobility Service Prefixes (MSPs) from which OMNI link MNPs are derived. If there are multiple OMNI links, the IPv6 layer will see multiple OMNI interfaces.



MNs may connect to multiple distinct OMNI links by configuring multiple OMNI interfaces, e.g., omni0, omni1, omni2, etc. Each OMNI interface is configured over a set of underlying interfaces and provides a nexus for Safety-Based Multilink (SBM) operation. The IP layer selects an OMNI interface based on SBM routing considerations, then the selected interface applies Performance-Based Multilink (PBM) to select the correct underlying interface. Applications can apply Segment Routing [[RFC8402](#)] to select independent SBM topologies for fault tolerance.

The OMNI interface interacts with a network-based Mobility Service (MS) through IPv6 Neighbor Discovery (ND) control message exchanges [[RFC4861](#)]. The MS provides Mobility Service Endpoints (MSEs) that track MN movements and represent their MNPs in a global routing or mapping system.

This document specifies the transmission of IP packets and MN/MS control messages over OMNI interfaces. The OMNI interface supports either IP protocol version (i.e., IPv4 [[RFC0791](#)] or IPv6 [[RFC8200](#)]) as the network layer in the data plane, while using IPv6 ND messaging as the control plane independently of the data plane IP protocol(s). The OMNI Adaptation Layer (OAL) which operates as a mid-layer between L3 and L2 is based on IP-in-IPv6 encapsulation per [[RFC2473](#)] as discussed in the following sections.

## 2. Terminology

The terminology in the normative references applies; especially, the terms "link" and "interface" are the same as defined in the IPv6 [[RFC8200](#)] and IPv6 Neighbor Discovery (ND) [[RFC4861](#)] specifications. Additionally, this document assumes the following IPv6 ND message types: Router Solicitation (RS), Router Advertisement (RA), Neighbor Solicitation (NS), Neighbor Advertisement (NA) and Redirect.

The Protocol Constants defined in [Section 10 of \[\[RFC4861\]\(#\)\]](#) are used in their same format and meaning in this document. The terms "All-Routers multicast", "All-Nodes multicast" and "Subnet-Router anycast" are the same as defined in [[RFC4291](#)] (with Link-Local scope assumed).

The term "IP" is used to refer collectively to either Internet Protocol version (i.e., IPv4 [[RFC0791](#)] or IPv6 [[RFC8200](#)]) when a specification at the layer in question applies equally to either version.

The following terms are defined within the scope of this document:

Mobile Node (MN)



an end system with a mobile router having multiple distinct upstream data link connections that are grouped together in one or more logical units. The MN's data link connection parameters can change over time due to, e.g., node mobility, link quality, etc. The MN further connects a downstream-attached End User Network (EUN). The term MN used here is distinct from uses in other documents, and does not imply a particular mobility protocol.

#### End User Network (EUN)

a simple or complex downstream-attached mobile network that travels with the MN as a single logical unit. The IP addresses assigned to EUN devices remain stable even if the MN's upstream data link connections change.

#### Mobility Service (MS)

a mobile routing service that tracks MN movements and ensures that MNs remain continuously reachable even across mobility events. Specific MS details are out of scope for this document.

#### Mobility Service Endpoint (MSE)

an entity in the MS (either singular or aggregate) that coordinates the mobility events of one or more MN.

#### Mobility Service Prefix (MSP)

an aggregated IP prefix (e.g., 2001:db8::/32, 192.0.2.0/24, etc.) advertised to the rest of the Internetwork by the MS, and from which more-specific Mobile Network Prefixes (MNPs) are derived.

#### Mobile Network Prefix (MNP)

a longer IP prefix taken from an MSP (e.g., 2001:db8:1000:2000::/56, 192.0.2.8/30, etc.) and assigned to a MN. MNs sub-delegate the MNP to devices located in EUNs.

#### Access Network (ANET)

a data link service network (e.g., an aviation radio access network, satellite service provider network, cellular operator network, wifi network, etc.) that connects MNs. Physical and/or data link level security between the MN and ANET are assumed.

#### Access Router (AR)

a first-hop router in the ANET for connecting MNs to correspondents in outside Internetworks.

#### ANET interface

a MN's attachment to a link in an ANET.

#### Internetwork (INET)





a connected network region with a coherent IP addressing plan that provides transit forwarding services for ANET MNs and INET correspondents. Examples include private enterprise networks, ground domain aviation service networks and the global public Internet itself.

#### INET interface

a node's attachment to a link in an INET.

#### OMNI link

a Non-Broadcast, Multiple Access (NBMA) virtual overlay configured over one or more INETs and their connected ANETs. An OMNI link can comprise multiple INET segments joined by bridges the same as for any link; the addressing plans in each segment may be mutually exclusive and managed by different administrative entities.

#### OMNI interface

a node's attachment to an OMNI link, and configured over one or more underlying ANET/INET interfaces.

#### OMNI Adaptation Layer (OAL)

an OMNI interface process whereby packets admitted into the interface are wrapped in a mid-layer IPv6 header and fragmented/reassembled if necessary to support the OMNI link Maximum Transmission Unit (MTU). The OAL is also responsible for generating MTU-related control messages as necessary, and for providing addressing context for spanning multiple segments of a bridged OMNI link.

#### OMNI Link-Local Address (LLA)

a link local IPv6 address per [\[RFC4291\]](#) constructed as specified in [Section 7](#).

#### OMNI Unique-Local Address (ULA)

a unique local IPv6 address per [\[RFC4193\]](#) constructed as specified in [Section 8](#). OMNI ULAs are statelessly derived from OMNI LLAs, and vice-versa.

#### OMNI Option

an IPv6 Neighbor Discovery option providing multilink parameters for the OMNI interface as specified in [Section 9](#).

#### Multilink

an OMNI interface's manner of managing diverse underlying data link interfaces as a single logical unit. The OMNI interface provides a single unified interface to upper layers, while underlying data link selections are performed on a per-packet basis considering factors such as DSCP, flow label, application



policy, signal quality, cost, etc. Multilinking decisions are coordinated in both the outbound (i.e. MN to correspondent) and inbound (i.e., correspondent to MN) directions.

#### L2

The second layer in the OSI network model. Also known as "layer-2", "link-layer", "sub-IP layer", "data link layer", etc.

#### L3

The third layer in the OSI network model. Also known as "layer-3", "network-layer", "IP layer", etc.

#### underlying interface

an ANET/INET interface over which an OMNI interface is configured. The OMNI interface is seen as a L3 interface by the IP layer, and each underlying interface is seen as a L2 interface by the OMNI interface.

#### Mobility Service Identification (MSID)

Each MSE and AR is assigned a unique 32-bit Identification (MSID) as specified in [Section 7](#).

#### Safety-Based Multilink (SBM)

A means for ensuring fault tolerance through redundancy by connecting multiple independent OMNI interfaces to independent routing topologies (i.e., multiple independent OMNI links).

#### Performance Based Multilink (PBM)

A means for selecting underlying interface(s) for packet transmission and reception within a single OMNI interface.

### 3. Requirements

The key words "MUST", "MUST NOT", "REQUIRED", "SHALL", "SHALL NOT", "SHOULD", "SHOULD NOT", "RECOMMENDED", "NOT RECOMMENDED", "MAY", and "OPTIONAL" in this document are to be interpreted as described in [BCP 14 \[RFC2119\]](#)[RFC8174] when, and only when, they appear in all capitals, as shown here.

OMNI links maintain a constant value "MAX\_MSID" selected to provide MNs with an acceptable level of MSE redundancy while minimizing control message amplification. It is RECOMMENDED that MAX\_MSID be set to the default value 5; if a different value is chosen, it should be set uniformly by all nodes on the OMNI link.

An implementation is not required to internally use the architectural constructs described here so long as its external behavior is consistent with that described in this document.



**4. Overlay Multilink Network (OMNI) Interface Model**

An OMNI interface is a MN virtual interface configured over one or more underlying interfaces, which may be physical (e.g., an aeronautical radio link) or virtual (e.g., an Internet or higher-layer "tunnel"). The MN receives a MNP from the MS, and coordinates with the MS through IPv6 ND message exchanges. The MN uses the MNP to construct a unique OMNI LLA through the algorithmic derivation specified in [Section 7](#) and assigns the LLA to the OMNI interface.

The OMNI interface architectural layering model is the same as in [\[RFC5558\]](#)[\[RFC7847\]](#), and augmented as shown in Figure 1. The IP layer therefore sees the OMNI interface as a single L3 interface with multiple underlying interfaces that appear as L2 communication channels in the architecture.

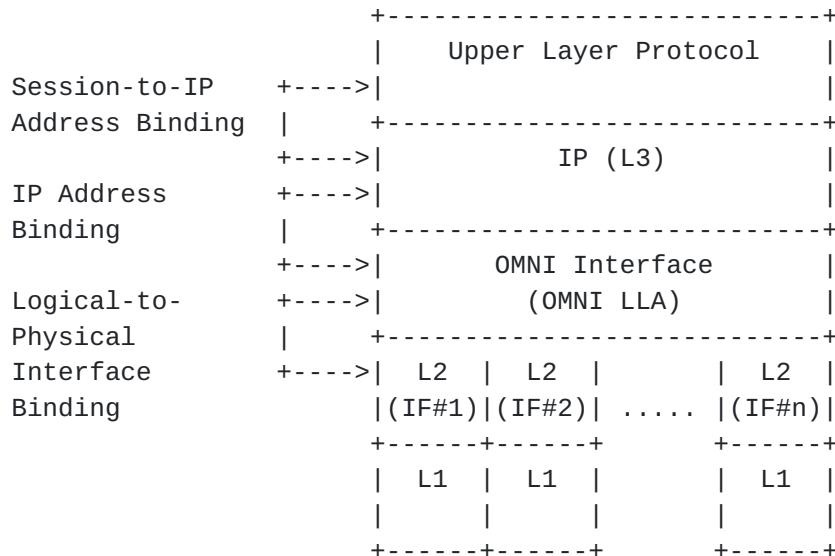

Figure 1: OMNI Interface Architectural Layering Model

The OMNI virtual interface model gives rise to a number of opportunities:

- o since OMNI LLAs are uniquely derived from an MNP, no Duplicate Address Detection (DAD) or Multicast Listener Discovery (MLD) messaging is necessary.
- o ANET interfaces do not require any L3 addresses (i.e., not even link-local) in environments where communications are coordinated entirely over the OMNI interface. (An alternative would be to also assign the same OMNI LLA to all ANET interfaces.)



- o as ANET interface properties change (e.g., link quality, cost, availability, etc.), any active ANET interface can be used to update the profiles of multiple additional ANET interfaces in a single message. This allows for timely adaptation and service continuity under dynamically changing conditions.
- o coordinating ANET interfaces in this way allows them to be represented in a unified MS profile with provisions for mobility and multilink operations.
- o exposing a single virtual interface abstraction to the IPv6 layer allows for multilink operation (including QoS based link selection, packet replication, load balancing, etc.) at L2 while still permitting L3 traffic shaping based on, e.g., DSCP, flow label, etc.
- o L3 sees the OMNI interface as a point of connection to the OMNI link; if there are multiple OMNI links (i.e., multiple MS's), L3 will see multiple OMNI interfaces.
- o Multiple independent OMNI interfaces can be used for increased fault tolerance through Safety-Based Multilink (SBM), with Performance-Based Multilink (PBM) applied within each interface.

Other opportunities are discussed in [[RFC7847](#)].

Figure 2 depicts the architectural model for a MN connecting to the MS via multiple independent ANETs. When an underlying interface becomes active, the MN's OMNI interface sends native (i.e., unencapsulated) IPv6 ND messages via the underlying interface. IPv6 ND messages traverse the ground domain ANETs until they reach an Access Router (AR#1, AR#2, .., AR#n). The AR then coordinates with a Mobility Service Endpoint (MSE#1, MSE#2, ..., MSE#m) in the INET and returns an IPv6 ND message response to the MN. IPv6 ND messages traverse the ANET at layer 2; hence, the Hop Limit is not decremented.





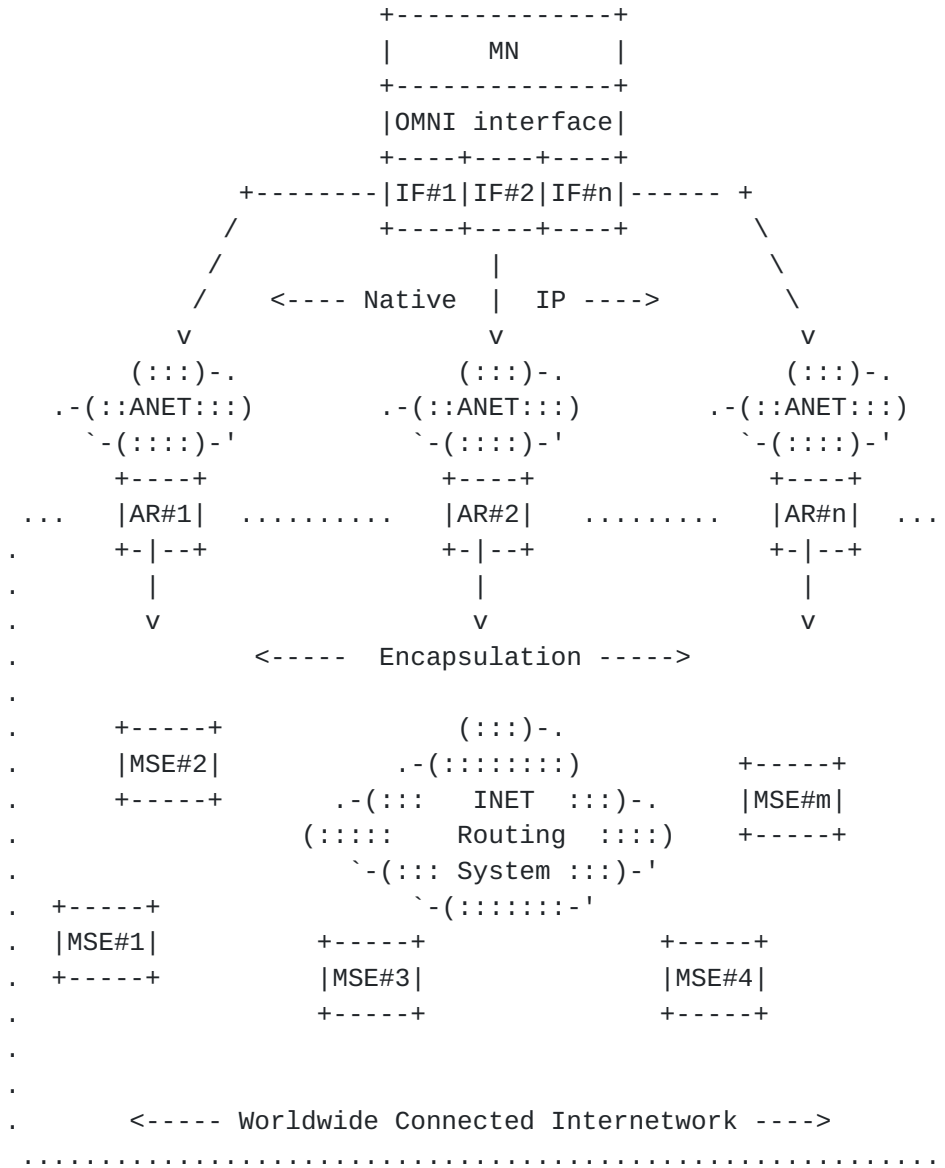

Figure 2: MN/MS Coordination via Multiple ANETs

After the initial IPv6 ND message exchange, the MN can send and receive unencapsulated IP data packets over the OMNI interface. OMNI interface multilink services will forward the packets via ARs in the correct underlying ANETs. The AR encapsulates the packets according to the capabilities provided by the MS and forwards them to the next hop within the worldwide connected Internetwork via optimal routes.

OMNI links span one or more underlying Internetwork via the OMNI Adaptation Layer (OAL) which is based on a mid-layer overlay encapsulation using [RFC2473] with [RFC4193] addressing. Each OMNI link corresponds to a different overlay (differentiated by an address codepoint) which may be carried over a completely separate underlying



topology. Each MN can facilitate SBM by connecting to multiple OMNI links using a distinct OMNI interface for each link.

## 5. The OMNI Adaptation Layer (OAL)

The OMNI interface observes the link nature of tunnels, including the Maximum Transmission Unit (MTU), Maximum Reassembly Unit (MRU) and the role of fragmentation and reassembly [[I-D.ietf-intarea-tunnels](#)]. The OMNI interface is configured over one or more underlying interfaces that may have diverse MTUs. OMNI interfaces accommodate MTU diversity through the use of the OMNI Adaptation Layer (OAL) as discussed in this section.

IPv6 underlying interfaces are REQUIRED to configure a minimum MTU of 1280 bytes and a minimum MRU of 1500 bytes [[RFC8200](#)], meaning that the minimum IPv6 path MTU is 1280 bytes since routers on the path are not permitted to perform network fragmentation even though the destination is required to reassemble more. The network therefore MUST forward packets of at least 1280 bytes without generating an IPv6 Path MTU Discovery (PMTUD) Packet Too Big (PTB) message [[RFC8201](#)]. (Note: the source can apply "source fragmentation" for locally-generated IPv6 packets up to 1500 bytes and larger still if it has a way to determine that the destination configures a larger MRU, but this does not affect the minimum IPv6 path MTU.)

IPv4 underlying interfaces are REQUIRED to configure a minimum MTU of 68 bytes [[RFC0791](#)] and a minimum MRU of 576 bytes [[RFC0791](#)][[RFC1122](#)]. Therefore, when the Don't Fragment (DF) bit in the IPv4 header is set to 0 the minimum IPv4 path MTU is 576 bytes since routers on the path support network fragmentation and the destination is required to reassemble at least that much. The DF bit in the IPv4 encapsulation headers of packets sent over IPv4 underlying interfaces therefore MUST be set to 0. (Note: even if the encapsulation source has a way to determine that the encapsulation destination configures an MRU larger than 576 bytes, it should not assume a larger minimum IPv4 path MTU without careful consideration of the issues discussed in [Section 5.1](#).)

The OMNI interface configures both an MTU and MRU of 9180 bytes [[RFC2492](#)]; the size is therefore not a reflection of the underlying interface MTUs, but rather determines the largest packet the OMNI interface can forward or reassemble. The OMNI interface uses the OMNI Adaptation Layer (OAL) to admit packets from the network layer that are no larger than the OMNI interface MTU while generating ICMPv4 Fragmentation Needed [[RFC1191](#)] or ICMPv6 Path MTU Discovery (PMTUD) Packet Too Big (PTB) [[RFC8201](#)] messages as necessary. We refer to both of these ICMPv4/ICMPv6 message types simply as "PTBs".



For IPv4 packets with DF=0 and locally-generated IPv6 packets, the network layer performs IP fragmentation according to the OMNI interface MTU if necessary then admits the packets/fragments into the interface. For IPv4 packets with DF=1 and non-locally-generated IPv6 packets, the network layer admits each packet that is no larger than the OMNI interface MTU; otherwise, it drops the packet and returns a PTB "hard error" message to the source.

For each admitted IP packet/fragment, the OMNI interface internally employs the OAL by either inserting or omitting a mid-layer IPv6 header between the inner IP packet/fragment and any outer IP encapsulation headers per [RFC2473]. The OAL then fragments this mid-layer IPv6 packet when necessary, and returns internally-generated PTB "soft" error messages for packets that it deems too large (e.g., according to link performance characteristics, reassembly congestion, etc.) while forwarding the packets/fragments without loss. This ensures that the path MTU is adaptive and reflects the current path used for a given data flow.

The OAL operates with respect to both the minimum IPv6 and IPv4 path MTUs as follows:

- o When an OMNI interface sends a packet toward a final destination via an ANET peer, it sends without OAL encapsulation if the packet (including any outer-layer ANET encapsulations) is no larger than the underlying interface MTU for on-link ANET peers or the minimum ANET path MTU for peers separated by multiple IP hops. Otherwise, the OAL inserts an IPv6 header per [RFC2473] with source address set to the node's own OMNI Unique Local Address (ULA) (see: [Section 8](#)) and destination set to the OMNI ULA of the ANET peer. The OAL then uses IPv6 fragmentation to break the packet into a minimum number of non-overlapping fragments, where the largest fragment size (including both the OMNI and any outer-layer ANET encapsulations) is determined by the underlying interface MTU for on-link ANET peers or the minimum ANET path MTU for peers separated by multiple IP hops. The OAL then encapsulates the fragments in any ANET headers and sends them to the ANET peer, which reassembles before forwarding toward the final destination.
- o When an OMNI interface sends a packet toward a final destination via an INET interface, it sends packets (including any outer-layer INET encapsulations) no larger than the minimum INET path MTU without OAL encapsulation if the destination is reached via an INET address within the same OMNI link segment. Otherwise, the OAL inserts an IPv6 header per [RFC2473] with source address set to the node's OMNI ULA, destination set to the ULA of the next hop OMNI node toward the final destination and (if necessary) with a Segment Routing Header with the remaining Segment IDs on the path



to the final destination. The OAL then uses IPv6 fragmentation to break the packet into a minimum number of non-overlapping fragments, where the largest fragment size (including both the OMNI and outer-layer INET encapsulations) is the minimum INET path MTU, and the smallest fragment size is no smaller than 256 bytes (i.e., slightly less than half the minimum IPv4 path MTU). The OAL then encapsulates the fragments in any INET headers and sends them to the OMNI link neighbor, which reassembles before forwarding toward the final destination.

The OAL unconditionally drops all OAL fragments received from an INET peer that are smaller than 256 bytes (note that no minimum fragment size is specified for ANET peers since the underlying ANET is secured against tiny fragment attacks). In order to set the correct context for reassembly, the OAL of the OMNI interface that inserts the IPv6 header MUST also be the one that inserts the IPv6 Fragment Header Identification value. While not strictly required, sending all fragments of the same fragmented OAL packet consecutively over the same underlying interface with minimal inter-fragment delay may increase the likelihood of successful reassembly.

Ordinary PTB messages with ICMPv4 header "unused" field or ICMPv6 header Code field value 0 are "hard errors" that always indicate that a packet has been dropped due to a real MTU restriction. However, the OAL can also forward large packets via encapsulation and fragmentation while at the same time returning PTB "soft error" messages (subject to rate limiting) indicating that a forwarded packet was uncomfortably large. The OMNI interface can therefore continuously forward large packets without loss while returning PTB soft error messages recommending a smaller size. Original sources that receive the soft errors in turn reduce the size of the packets they send, i.e., the same as for hard errors.

The OAL sets the ICMPv4 header "unused" field or ICMPv6 header Code field to the value 1 in PTB soft error messages. Receiving nodes that recognize the code reduce their estimate of the path MTU the same as for hard errors but do not regard the message as a loss indication. Nodes that do not recognize the code treat the message the same as a hard error, but should heed the retransmission advice given in [[RFC8201](#)] which suggests retransmission based on normal packetization layer retransmission timers. This document therefore updates [[RFC1191](#)][RFC4443] and [[RFC8201](#)]. Furthermore, implementations of [[RFC4821](#)] must be aware that PTB hard or soft errors may arrive at any time even if after a successful MTU probe (this is the same consideration as for an ordinary path fluctuation following a successful probe).





In summary, the OAL supports continuous transmission and reception of packets of various sizes in the face of dynamically changing network conditions. Moreover, since PTB soft errors do not indicate loss, original sources that receive soft errors can quickly scan for path MTU increases without waiting for the minimum 10 minutes specified for loss-oriented PTB hard errors [[RFC1191](#)][RFC8201]. The OAL therefore provides a lossless and adaptive service that accommodates MTU diversity especially well suited for dynamic multilink environments.

Note: In network paths where IPv6/IPv4 protocol translation or IPv6-in-IPv4 encapsulation may be prevalent, it may be prudent for the OAL to always assume the IPv4 minimum path MTU (i.e., 576 bytes) regardless of the underlying interface IP protocol version. Always assuming the IPv4 minimum path MTU even for IPv6 underlying interfaces may produce more fragments and additional header overhead, but will always interoperate and never run the risk of presenting an IPv4 node with a packet that exceeds its MRU.

Note: An OMNI interface that reassembles OAL fragments may experience congestion-oriented loss in its reassembly cache and can optionally send PTB soft errors to the original source and/or ICMP "Time Exceeded" messages to the source of the OAL fragments. In environments where the messages may contribute to unacceptable additional congestion, however, the OMNI interface can simply regard the loss as an ordinary unreported congestion event for which the original source will eventually compensate.

### **5.1. Fragmentation Security Implications**

As discussed in [Section 3.7 of \[RFC8900\]](#), there are four basic threats concerning IPv6 fragmentation; each of which is addressed by effective mitigations as follows:

1. Overlapping fragment attacks - reassembly of overlapping fragments is forbidden by [[RFC8200](#)]; therefore, this threat does not apply to the OAL.
2. Resource exhaustion attacks - this threat is mitigated by providing a sufficiently large OAL reassembly cache and instituting "fast discard" of incomplete reassemblies that may be part of a buffer exhaustion attack. The reassembly cache should be sufficiently large so that a sustained attack does not cause excessive loss of good reassemblies but not so large that (timer-based) data structure management becomes computationally expensive. The cache should also be indexed based on the arrival underlying interface such that congestion experienced over a



first underlying interface does not cause discard of incomplete reassemblies for uncongested underlying interfaces.

3. Attacks based on predictable fragment identification values - this threat is mitigated by selecting a suitably random ID value per [\[RFC7739\]](#).
4. Evasion of Network Intrusion Detection Systems (NIDS) - this threat is mitigated by disallowing "tiny fragments" per the OAL fragmentation procedures specified above.

Additionally, IPv4 fragmentation includes a 16-bit Identification (IP ID) field with only 65535 unique values such that at high data rates the field could wrap and apply to new packets while the fragments of old packets using the same ID are still alive in the network [\[RFC4963\]](#). However, since the largest OAL fragment that will be sent via an IPv4 INET path is 576 bytes any IPv4 fragmentation would occur only on links with an IPv4 MTU smaller than this size, and [\[RFC3819\]](#) recommendations suggest that such links will have low data rates. Since IPv6 provides a 32-bit Identification value, IP ID wraparound at high data rates is not a concern for IPv6 fragmentation.

## **6. Frame Format**

The OMNI interface transmits IPv6 packets according to the native frame format of each underlying interface. For example, for Ethernet-compatible interfaces the frame format is specified in [\[RFC2464\]](#), for aeronautical radio interfaces the frame format is specified in standards such as ICAO Doc 9776 (VDL Mode 2 Technical Manual), for tunnels over IPv6 the frame format is specified in [\[RFC2473\]](#), etc.

## **7. Link-Local Addresses (LLAs)**

OMNI interfaces construct IPv6 Link-Local Addresses (i.e., "OMNI LLAs") as follows:

- o IPv6 MN OMNI LLAs encode the most-significant 112 bits of a MNP within the least-significant 112 bits of the IPv6 link-local prefix `fe80::/16`. The Prefix Length is determined by adding 16 to the length of the embedded MNP. For example, for the MNP `2001:db8:1000:2000::/56` the corresponding MN OMNI LLA is `fe80:2001:db8:1000:2000::/72`. This specification updates the IPv6 link-local address format specified in [Section 2.5.6 of \[RFC4291\]](#) by defining a use for bits 11 - 63.
- o IPv4-compatible MN OMNI LLAs are constructed as `fe80::ffff:[IPv4]`, i.e., the most significant 16 bits of the prefix `fe80::/16`,



followed by 64 '0' bits, followed by 16 '1' bits, followed by a 32bit IPv4 address/prefix. The Prefix Length is determined by adding 96 to the length of the embedded IPv4 address/prefix. For example, the IPv4-Compatible MN OMNI LLA for 192.0.2.0/24 is fe80::ffff:192.0.2.0/120 (also written as fe80::ffff:c000:0200/120).

- o MS OMNI LLAs are assigned to ARs and MSEs from the range fe80::/96, and MUST be managed for uniqueness. The lower 32 bits of the LLA includes a unique integer "MSID" value between 0x00000001 and 0xfeffffff, e.g., as in fe80::1, fe80::2, fe80::3, etc., fe80::feff:ffff. The MS OMNI LLA Prefix Length is determined by adding 96 to the MSID prefix length. For example, if the MSID '0x10002000' prefix length is 16 then the MS OMNI LLA Prefix Length is set to 112 and the LLA is written as fe80::1000:2000/112. Finally, the MSID 0x00000000 is the "Anycast" MSID and corresponds to the link-local Subnet-Router anycast address (fe80::) [[RFC4291](#)]; the MSID range 0xff000000 through 0xffffffff is reserved for future use.
- o The OMNI LLA range fe80::/32 is used as the service prefix for the address format specified in [Section 4 of \[RFC4380\]](#) (see [Section 17](#) for further discussion).

Since the prefix 0000::/8 is "Reserved by the IETF" [[RFC4291](#)], no MNPs can be allocated from that block ensuring that there is no possibility for overlap between the above OMNI LLA constructs.

Since MN OMNI LLAs are based on the distribution of administratively assured unique MNPs, and since MS OMNI LLAs are guaranteed unique through administrative assignment, OMNI interfaces set the autoconfiguration variable DupAddrDetectTransmits to 0 [[RFC4862](#)].

## 8. Unique-Local Addresses (ULAs)

OMNI links use IPv6 Unique Local Addresses (i.e., "OMNI ULAs") [[RFC4193](#)] as the source and destination addresses in OAL IPv6 encapsulation headers. This document currently assumes use of the ULA prefix fc80::/10 for mapping OMNI LLAs to routable OMNI ULAs (however, see the note at the end of this section).

Each OMNI link instance is identified by bits 10-15 of the OMNI service prefix fc80::/10. For example, OMNI ULAs associated with instance 0 are configured from the prefix fc80::/16, instance 1 from fc81::/16, etc., up to instance 63 from fcbf::/16. OMNI ULAs and their associated prefix lengths are configured in one-to-one correspondence with OMNI LLAs through stateless prefix translation. For example, for OMNI link instance fc80::/16:



- o the OMNI ULA corresponding to fe80:2001:db8:1:2::/80 is simply fc80:2001:db8:1:2::/80
- o the OMNI ULA corresponding to fe80::ffff:192.0.2.0/120 is simply fc80::ffff:192.0.2.0/120
- o the OMNI ULA corresponding to fe80::1000/112 is simply fc80::1000/112
- o the OMNI ULA corresponding to fe80::/128 is simply fc80:/128.

Each OMNI interface assigns the Anycast OMNI ULA specific to the OMNI link instance, e.g., the OMNI interface connected to instance 3 assigns the Anycast OMNI ULA fc83:. Routers that configure OMNI interfaces advertise the OMNI service prefix (e.g., fc83::/16) into the local routing system so that applications can direct traffic according to SBM requirements.

The OMNI ULA presents an IPv6 address format that is routable within the OMNI link routing system and can be used to convey link-scoped messages across multiple hops using IPv6 encapsulation [[RFC2473](#)]. The OMNI link extends across one or more underlying Internetworks to include all ARs and MSEs. All MNs are also considered to be connected to the OMNI link, however OAL encapsulation is omitted over ANET links when possible to conserve bandwidth (see: [Section 11](#)).

The OMNI link can be subdivided into "segments" that often correspond to different administrative domains or physical partitions. OMNI nodes can use IPv6 Segment Routing [[RFC8402](#)] when necessary to support efficient packet forwarding to destinations located in other OMNI link segments. A full discussion of Segment Routing over the OMNI link appears in [[I-D.templin-intarea-6706bis](#)].

NOTE: An alternative to the application of ULAs as discussed in this document would be to re-purpose the deprecated IPv6 Site-Local Address (SLA) range fec0::/10 [[RFC3879](#)]. In many ways, re-purposing SLAs would be a more natural fit since both LLA and SLA prefix lengths are ::/10, the prefixes fe80:: and fec0:: differ only in a single bit setting, and LLAs and SLAs can be unambiguously allocated in one-to-one correspondence with one another. Re-purposing SLAs would also make good use of an otherwise-wasted address range that has been "parked" since the 2004 deprecation. However, moving from ULAs to SLAs would require an IETF standards action acknowledging this document as obsoleting [[RFC3879](#)] and updating [[RFC4291](#)]. The authors therefore defer to IETF consensus as to the proper way forward.





**9. Address Mapping - Unicast**

OMNI interfaces maintain a neighbor cache for tracking per-neighbor state and use the link-local address format specified in [Section 7](#). OMNI interface IPv6 Neighbor Discovery (ND) [[RFC4861](#)] messages sent over physical underlying interfaces without encapsulation observe the native underlying interface Source/Target Link-Layer Address Option (S/TLLAO) format (e.g., for Ethernet the S/TLLAO is specified in [[RFC2464](#)]). OMNI interface IPv6 ND messages sent over underlying interfaces via encapsulation do not include S/TLLAOs which were intended for encoding physical L2 media address formats and not encapsulation IP addresses. Furthermore S/TLLAOs are not intended for encoding additional interface attributes. Hence, this document does not define an S/TLLAO format but instead defines a new option type termed the "OMNI option" designed for these purposes.

MNs such as aircraft typically have many wireless data link types (e.g. satellite-based, cellular, terrestrial, air-to-air directional, etc.) with diverse performance, cost and availability properties. The OMNI interface would therefore appear to have multiple L2 connections, and may include information for multiple underlying interfaces in a single IPv6 ND message exchange. OMNI interfaces use an IPv6 ND option called the OMNI option formatted as shown in Figure 3:

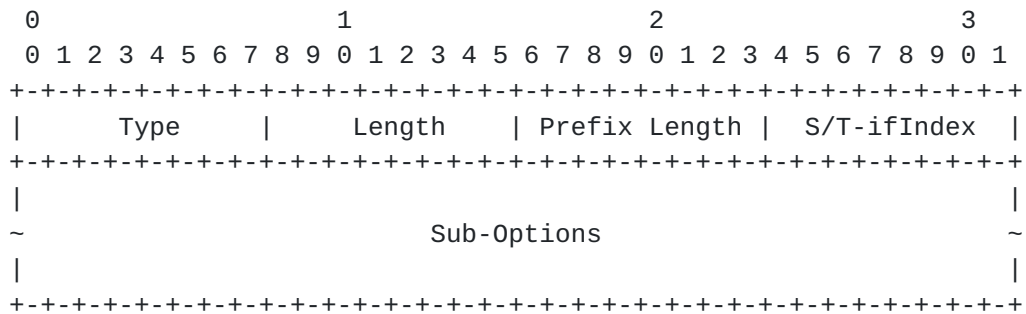

Figure 3: OMNI Option Format

In this format:

- o Type is set to TBD. If multiple OMNI option instances appear in the same IPv6 ND message, the first instance is processed and all other instances are ignored.
- o Length is set to the number of 8 octet blocks in the option.
- o Prefix Length is determines the length of prefix to be applied to an OMNI MN LLA/ULA. For IPv6 ND messages sent from a MN to the MS, Prefix Length is the length that the MN is requesting or



asserting to the MS. For IPv6 ND messages sent from the MS to the MN, Prefix Length indicates the length that the MS is granting to the MN. For IPv6 ND messages sent between MS endpoints, Prefix Length indicates the length associated with the target MN that is subject of the ND message.

- o S/T-ifIndex corresponds to the ifIndex value for source or target underlying interface used to convey this IPv6 ND message. OMNI interfaces MUST number each distinct underlying interface with an ifIndex value between '1' and '255' that represents a MN-specific 8-bit mapping for the actual ifIndex value assigned by network management [[RFC2863](#)] (the ifIndex value '0' is reserved for use by the MS). For RS and NS messages, S/T-ifIndex corresponds to the source underlying interface the message originated from. For RA and NA messages, S/T-ifIndex corresponds to the target underlying interface that the message is destined to.
- o Sub-Options is a Variable-length field, of length such that the complete OMNI Option is an integer multiple of 8 octets long. Contains one or more Sub-Options, as described in [Section 9.1](#).

**9.1. Sub-Options**

The OMNI option includes zero or more Sub-Options. Each consecutive Sub-Option is concatenated immediately after its predecessor. All Sub-Options except Pad1 (see below) are in type-length-value (TLV) encoded in the following format:

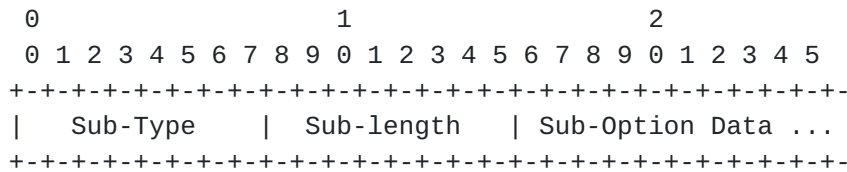

Figure 4: Sub-Option Format

- o Sub-Type is a 1-octet field that encodes the Sub-Option type. Sub-Options defined in this document are:



Option Name	Sub-Type
Pad1	0
PadN	1
Interface Attributes	2
Traffic Selector	3
MS-Register	4
MS-Release	5
Network Access Identifier	6
Geo Coordinates	7
DHCP Unique Identifier (DUID)	8

Figure 5

Sub-Types 253 and 254 are reserved for experimentation, as recommended in [[RFC3692](#)].

- o Sub-Length is a 1-octet field that encodes the length of the Sub-Option Data (i.e., ranging from 0 to 255 octets).
- o Sub-Option Data is a block of data with format determined by Sub-Type.

During processing, unrecognized Sub-Options are ignored and the next Sub-Option processed until the end of the OMNI option is reached.

The following Sub-Option types and formats are defined in this document:

**9.1.1. Pad1**

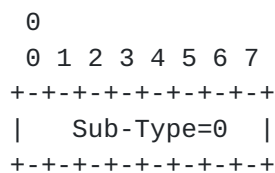

Figure 6: Pad1

- o Sub-Type is set to 0. If multiple instances appear in the same OMNI option all are processed.
- o No Sub-Length or Sub-Option Data follows (i.e., the "Sub-Option" consists of a single zero octet).



9.1.2. PadN

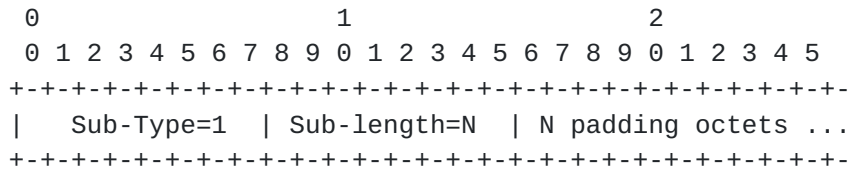

Figure 7: PadN

- o Sub-Type is set to 1. If multiple instances appear in the same OMNI option all are processed.
- o Sub-Length is set to N (from 0 to 255) being the number of padding octets that follow.
- o Sub-Option Data consists of N zero-valued octets.

9.1.3. Interface Attributes

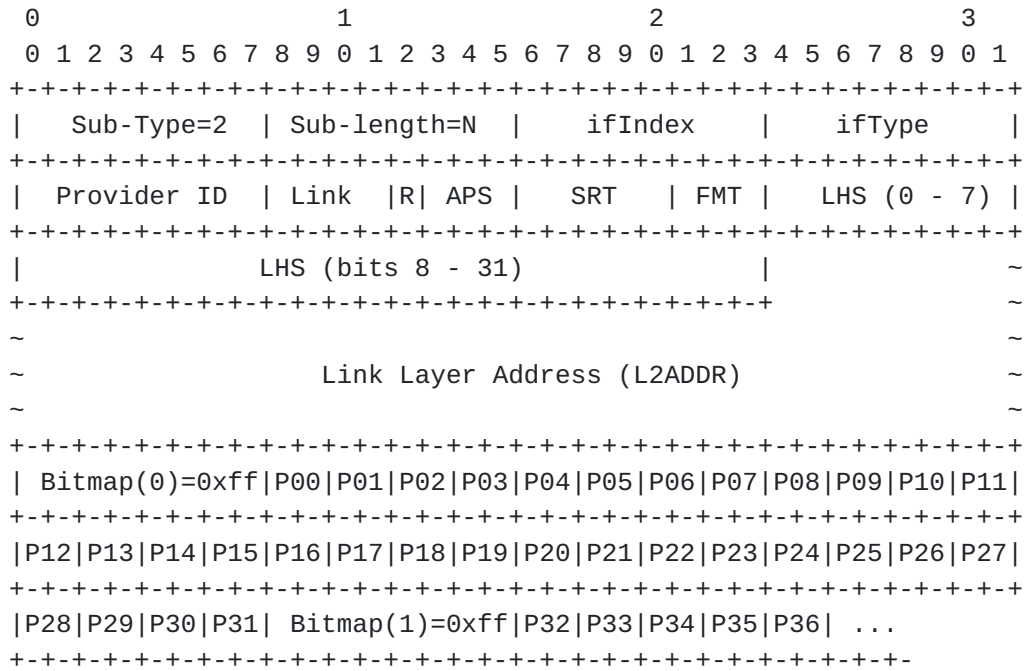

Figure 8: Interface Attributes

- o Sub-Type is set to 2. If multiple instances with different ifIndex values appear in the same OMNI option all are processed; if multiple instances with the same ifIndex value appear, the first is processed and all others are ignored.





- o Sub-Length is set to N (from 4 to 255) that encodes the number of Sub-Option Data octets that follow.
- o Sub-Option Data contains an "Interface Attribute" option encoded as follows (note that the first four octets must be present):
  - \* ifIndex is set to an 8-bit integer value corresponding to a specific underlying interface the same as specified above for the OMNI option header S/T-ifIndex. An OMNI option may include multiple Interface Attributes Sub-Options, with each distinct ifIndex value pertaining to a different underlying interface. The OMNI option will often include an Interface Attributes Sub-Option with the same ifIndex value that appears in the S/T-ifIndex. In that case, the actual encapsulation address of the received IPv6 ND message should be compared with the L2ADDR encoded in the Sub-Option (see below); if the addresses are different (or, if L2ADDR absent) the presence of a Network Address Translator (NAT) is indicated.
  - \* ifType is set to an 8-bit integer value corresponding to the underlying interface identified by ifIndex. The value represents an OMNI interface-specific 8-bit mapping for the actual IANA ifType value registered in the 'IANAifType-MIB' registry [<http://www.iana.org>].
  - \* Provider ID is set to an OMNI interface-specific 8-bit ID value for the network service provider associated with this ifIndex.
  - \* Link encodes a 4-bit link metric. The value '0' means the link is DOWN, and the remaining values mean the link is UP with metric ranging from '1' ("lowest") to '15' ("highest").
  - \* R is reserved for future use.
  - \* APS - a 3-bit "Address/Preferences/Simplex" code that determines the contents of the remainder of the sub-option as follows:
    - + When the most significant bit (i.e., "Address") is set to 1, the SRT, FMT, LHS and L2ADDR fields are included immediately following the APS code; else, they are omitted.
    - + When the next most significant bit (i.e., "Preferences") is set to 1, a preferences block is included next; else, it is omitted. (Note that if "Address" is set the preferences block immediately follows L2ADDR; else, it immediately follows the APS code.)



- + When a preferences block is present and the least significant bit (i.e., "Simplex") is set to 1, the block is encoded in "Simplex" form as shown in Figure 8; else it is encoded in "Indexed" form as discussed below.
- \* When APS indicates that an "Address" is included, the following fields appear in consecutive order (else, they are omitted):
  - + SRT - a 5-bit Segment Routing Topology prefix length value that (when added to 96) determines the prefix length to apply to the ULA formed from concatenating fc\*::/96 with the 32 bit LHS MSID value that follows. For example, the value 16 corresponds to the prefix length 112.
  - + FMT - a 3-bit "Framework/Mode/Type" code corresponding to the included Link Layer Address as follows:
    - When the most significant bit (i.e., "Framework") is set to 0, L2ADDR is the INET encapsulation address of a Proxy/Server; otherwise, it is the address for the Source/Target itself
    - When the next most significant bit (i.e., "Mode") is set to 0, the Source/Target L2ADDR is on the open INET; otherwise, it is (likely) located behind a Network Address Translator (NAT).
    - When the least significant bit (i.e., "Type") is set to 0, L2ADDR includes a UDP Port Number followed by an IPv4 address; else, a UDP Port Number followed by an IPv6 address.
  - + LHS - the 32 bit MSID of the Last Hop Server/Proxy on the path to the target. When SRT and LHS are both set to 0, the LHS is considered unspecified in this IPv6 ND message. When SRT is set to 0 and LHS is non-zero, the prefix length is set to 128. SRT and LHS provide guidance to the OMNI interface forwarding algorithm. Specifically, if SRT/LHS is located in the local OMNI link segment then the OMNI interface can encapsulate according to FMT/L2ADDR; else, it must forward according to the OMNI link spanning tree. See [[I-D.templin-intarea-6706bis](#)] for further discussion.
  - + Link Layer Address (L2ADDR) - Formatted according to FMT, and identifies the link-layer address (i.e., the encapsulation address) of the source/target. The UDP Port Number appears in the first two octets and the IP address appears in the next 4 octets for IPv4 or 16 octets for IPv6.



The Port Number and IP address are recorded in ones-compliment "obfuscated" form per [RFC4380]. The OMNI interface forwarding algorithm uses FMT/L2ADDR to determine the encapsulation address for forwarding when SRT/LHS is located in the local OMNI link segment.

- \* When APS indicates that "Preferences" are included, a preferences block appears as the remainder of the Sub-Option as a series of Bitmaps and P[\*] values. In "Simplex" form, the index for each singleton Bitmap octet is inferred from its sequential position (i.e., 0, 1, 2, ...) as shown in Figure 8. In "Indexed" form, each Bitmap is preceded by an Index octet that encodes a value "i" = (0 - 255) as the index for its companion Bitmap as follows:

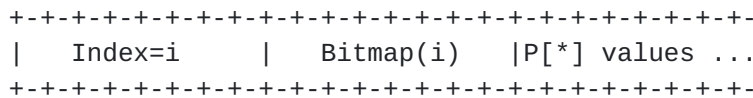

Figure 9

- \* The preferences consist of a first (simplex/indexed) Bitmap (i.e., "Bitmap(i)") followed by 0-8 single-octet blocks of 2-bit P[\*] values, followed by a second Bitmap (i), followed by 0-8 blocks of P[\*] values, etc. Reading from bit 0 to bit 7, the bits of each Bitmap(i) that are set to '1' indicate the P[\*] blocks from the range P[(i\*32)] through P[(i\*32) + 31] that follow; if any Bitmap(i) bits are '0', then the corresponding P[\*] block is instead omitted. For example, if Bitmap(0) contains 0xff then the block with P[00]-P[03], followed by the block with P[04]-P[07], etc., and ending with the block with P[28]-P[31] are included (as shown in Figure 8). The next Bitmap(i) is then consulted with its bits indicating which P[\*] blocks follow, etc. out to the end of the Sub-Option.
- \* Each 2-bit P[\*] field is set to the value '0' ("disabled"), '1' ("low"), '2' ("medium") or '3' ("high") to indicate a QoS preference for underlying interface selection purposes. Not all P[\*] values need to be included in the OMNI option of each IPV6 ND message received. Any P[\*] values represented in an earlier OMNI option but omitted in the current OMNI option remain unchanged. Any P[\*] values not yet represented in any OMNI option default to "medium".
- \* The first 16 P[\*] blocks correspond to the 64 Differentiated Service Code Point (DSCP) values P[00] - P[63] [RFC2474]. Any additional P[\*] blocks that follow correspond to "pseudo-DSCP"



traffic classifier values P[64], P[65], P[66], etc. See [Appendix A](#) for further discussion and examples.

9.1.4. Traffic Selector

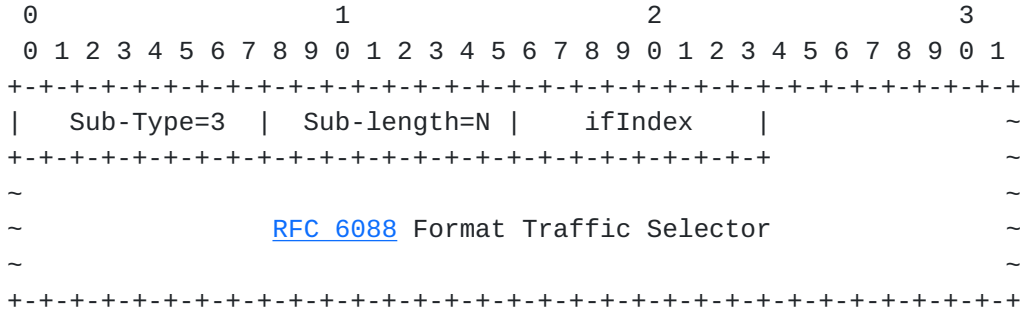

Figure 10: Traffic Selector

- o Sub-Type is set to 3. If multiple instances appear in the same OMNI option all are processed, i.e., even if the same ifIndex value appears multiple times.
- o Sub-Length is set to N (the number of Sub-Option Data octets that follow).
- o Sub-Option Data contains a 1-octet ifIndex encoded exactly as specified in [Section 9.1.3](#), followed by an N-1 octet traffic selector formatted per [\[RFC6088\]](#) beginning with the "TS Format" field. The largest traffic selector for a given ifIndex is therefore 254 octets.

9.1.5. MS-Register

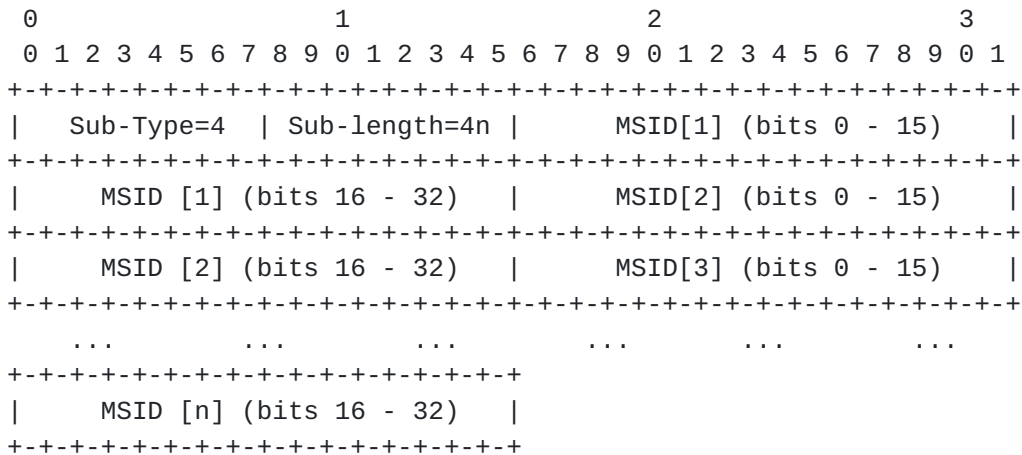

Figure 11: MS-Register Sub-option





- o Sub-Type is set to 4. If multiple instances appear in the same OMNI option all are processed. Only the first MAX\_MSID values processed (whether in a single instance or multiple) are retained and all other MSIDs are ignored.
- o Sub-Length is set to 4n.
- o A list of n 4-octet MSIDs is included in the following 4n octets. The Anycast MSID value '0' in an RS message MS-Register sub-option requests the recipient to return the MSID of a nearby MSE in a corresponding RA response.

9.1.6. MS-Release

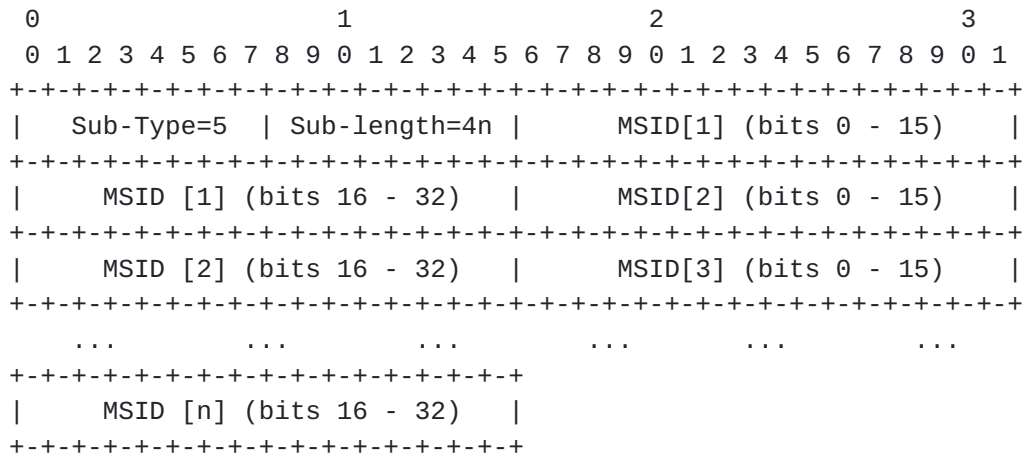

Figure 12: MS-Release Sub-option

- o Sub-Type is set to 5. If multiple instances appear in the same IPv6 OMNI option all are processed. Only the first MAX\_MSID values processed (whether in a single instance or multiple) are retained and all other MSIDs are ignored.
- o Sub-Length is set to 4n.
- o A list of n 4 octet MSIDs is included in the following 4n octets. The Anycast MSID value '0' is ignored in MS-Release sub-options, i.e., only non-zero values are processed.

9.1.7. Network Access Identifier (NAI)



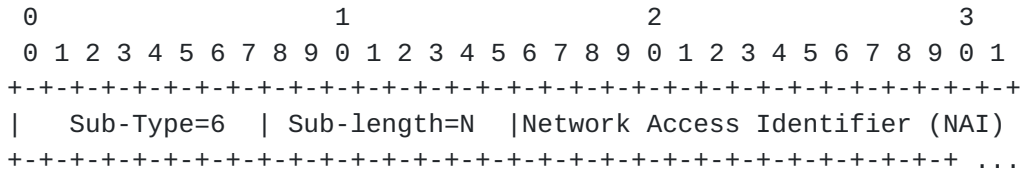

Figure 13: Network Access Identifier (NAI) Sub-option

- o Sub-Type is set to 6. If multiple instances appear in the same OMNI option the first is processed and all others are ignored.
- o Sub-Length is set to N.
- o A Network Access Identifier (NAI) up to 255 octets in length is coded per [RFC7542].

**9.1.8. Geo Coordinates**

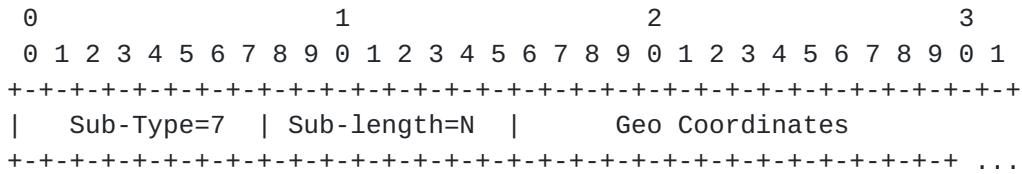

Figure 14: Geo Coordinates Sub-option

- o Sub-Type is set to 7. If multiple instances appear in the same OMNI option the first is processed and all others are ignored.
- o Sub-Length is set to N.
- o A set of Geo Coordinates up to 255 octets in length (format TBD). Includes Latitude/Longitude at a minimum; may also include additional attributes such as altitude, heading, speed, etc.).

**9.1.9. DHCP Unique Identifier (DUID)**

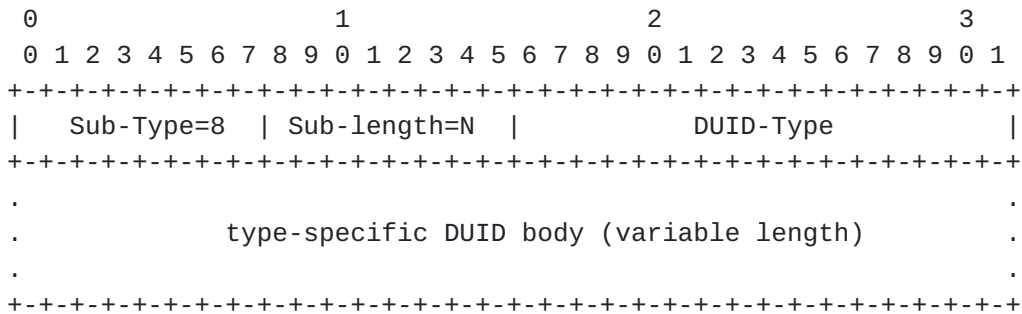

Figure 15: DHCP Unique Identifier (DUID) Sub-option



- o Sub-Type is set to 8. If multiple instances appear in the same OMNI option the first is processed and all others are ignored.
- o Sub-Length is set to N (i.e., the length of the option beginning with the DUID-Type and continuing to the end of the type-specific body).
- o DUID-Type is a two-octet field coded in network byte order that determines the format and contents of the type-specific body according to [Section 11 of \[RFC8415\]](#). DUID-Type 4 in particular corresponds to the Universally Unique Identifier (UUID) [[RFC6355](#)] which will occur in common operational practice.
- o A type-specific DUID body up to 253 octets in length follows, formatted according to DUID-type. For example, for type 4 the body consists of a 128-bit UUID selected according to [[RFC6355](#)].

## **10. Address Mapping - Multicast**

The multicast address mapping of the native underlying interface applies. The mobile router on board the MN also serves as an IGMP/MLD Proxy for its EUNs and/or hosted applications per [[RFC4605](#)] while using the L2 address of the AR as the L2 address for all multicast packets.

The MN uses Multicast Listener Discovery (MLDv2) [[RFC3810](#)] to coordinate with the AR, and ANET L2 elements use MLD snooping [[RFC4541](#)].

## **11. Conceptual Sending Algorithm**

The MN's IPv6 layer selects the outbound OMNI interface according to SBM considerations when forwarding data packets from local or EUN applications to external correspondents. Each OMNI interface maintains a neighbor cache the same as for any IPv6 interface, but with additional state for multilink coordination.

After a packet enters the OMNI interface, an outbound underlying interface is selected based on PBM traffic attributes such as DSCP, application port number, cost, performance, message size, etc. OMNI interface multilink selections could also be configured to perform replication across multiple underlying interfaces for increased reliability at the expense of packet duplication.

When the OMNI interface sends a packet over a selected outbound underlying interface, the OAL includes or omits a mid-layer encapsulation header as necessary as discussed in [Section 5](#). The OAL



also performs encapsulation when the nearest AR is located multiple hops away as discussed in [Section 12.1](#).

OMNI interface multilink service designers MUST observe the BCP guidance in [Section 15 \[RFC3819\]](#) in terms of implications for reordering when packets from the same flow may be spread across multiple underlying interfaces having diverse properties.

### **[11.1. Multiple OMNI Interfaces](#)**

MNs may connect to multiple independent OMNI links concurrently in support of SBM. Each OMNI interface is distinguished by its Anycast OMNI ULA (e.g., fc80::, fc81::, fc82::). The MN configures a separate OMNI interface for each link so that multiple interfaces (e.g., omni0, omni1, omni2, etc.) are exposed to the IPv6 layer. A different Anycast OMNI ULA is assigned to each interface, and the MN injects the service prefixes for the OMNI link instances into the EUN routing system.

Applications in EUNs can use Segment Routing to select the desired OMNI interface based on SBM considerations. The Anycast OMNI ULA is written into the IPv6 destination address, and the actual destination (along with any additional intermediate hops) is written into the Segment Routing Header. Standard IP routing directs the packets to the MN's mobile router entity, and the Anycast OMNI ULA identifies the OMNI interface to be used for transmission to the next hop. When the MN receives the message, it replaces the IPv6 destination address with the next hop found in the routing header and transmits the message over the OMNI interface identified by the Anycast OMNI ULA.

Multiple distinct OMNI links can therefore be used to support fault tolerance, load balancing, reliability, etc. The architectural model is similar to Layer 2 Virtual Local Area Networks (VLANs).

## **[12. Router Discovery and Prefix Registration](#)**

MNs interface with the MS by sending RS messages with OMNI options under the assumption that one or more AR on the ANET will process the message and respond. The manner in which the ANET ensures AR coordination is link-specific and outside the scope of this document (however, considerations for ANETs that do not provide ARs that recognize the OMNI option are discussed in [Section 17](#)).

For each underlying interface, the MN sends an RS message with an OMNI option to coordinate with MSEs identified by MSID values. Example MSID discovery methods are given in [\[RFC5214\]](#) and include data link login parameters, name service lookups, static configuration, a static "hosts" file, etc. The MN can also send an





RS with an MS-Register suboption that includes the Anycast MSID value '0', i.e., instead of or in addition to any non-zero MSIDs. When the AR receives an RS with a MSID '0', it selects a nearby MSE (which may be itself) and returns an RA with the selected MSID in an MS-Register suboption. The AR selects only a single wildcard MSE (i.e., even if the RS MS-Register suboption included multiple '0' MSIDs) while also soliciting the MSEs corresponding to any non-zero MSIDs.

MNs configure OMNI interfaces that observe the properties discussed in the previous section. The OMNI interface and its underlying interfaces are said to be in either the "UP" or "DOWN" state according to administrative actions in conjunction with the interface connectivity status. An OMNI interface transitions to UP or DOWN through administrative action and/or through state transitions of the underlying interfaces. When a first underlying interface transitions to UP, the OMNI interface also transitions to UP. When all underlying interfaces transition to DOWN, the OMNI interface also transitions to DOWN.

When an OMNI interface transitions to UP, the MN sends RS messages to register its MNP and an initial set of underlying interfaces that are also UP. The MN sends additional RS messages to refresh lifetimes and to register/deregister underlying interfaces as they transition to UP or DOWN. The MN sends initial RS messages over an UP underlying interface with its OMNI LLA as the source and with destination set to All-Routers multicast (ff02::2) [[RFC4291](#)]. The RS messages include an OMNI option per [Section 9](#) with valid prefix registration information, Interface Attributes appropriate for underlying interfaces, MS-Register/Release sub-options containing MSID values, and with any other necessary OMNI sub-options. The S/T-ifIndex field is set to the index of the underlying interface over which the RS message is sent.

ARs process IPv6 ND messages with OMNI options and act as an MSE themselves and/or as a proxy for other MSEs. ARs receive RS messages and create a neighbor cache entry for the MN, then coordinate with any MSEs named in the Register/Release lists in a manner outside the scope of this document. When an MSE processes the OMNI information, it first validates the prefix registration information then injects/withdraws the MNP in the routing/mapping system and caches/discards the new Prefix Length, MNP and Interface Attributes. The MSE then informs the AR of registration success/failure, and the AR returns an RA message to the MN with an OMNI option per [Section 9](#).

The AR returns the RA message via the same underlying interface of the MN over which the RS was received, and with destination address set to the MN OMNI LLA (i.e., unicast), with source address set to its own OMNI LLA, and with an OMNI option with S/T-ifIndex set to the



value included in the RS. The OMNI option also includes valid prefix registration information, Interface Attributes, MS-Register/Release and any other necessary OMNI sub-options. The RA also includes any information for the link, including RA Cur Hop Limit, M and O flags, Router Lifetime, Reachable Time and Retrans Timer values, and includes any necessary options such as:

- o PIOs with (A; L=0) that include MSPs for the link [[RFC8028](#)].
- o RIOs [[RFC4191](#)] with more-specific routes.
- o an MTU option that specifies the maximum acceptable packet size for this ANET interface.

The AR MAY also send periodic and/or event-driven unsolicited RA messages per [[RFC4861](#)]. In that case, the S/T-ifIndex field in the OMNI header of the unsolicited RA message identifies the target underlying interface of the destination MN.

The AR can combine the information from multiple MSEs into one or more "aggregate" RAs sent to the MN in order conserve ANET bandwidth. Each aggregate RA includes an OMNI option with MS-Register/Release sub-options with the MSEs represented by the aggregate. If an aggregate is sent, the RA message contents must consistently represent the combined information advertised by all represented MSEs. Note that since the AR uses its own OMNI LLA as the RA source address, the MN determines the addresses of the represented MSEs by examining the MS-Register/Release OMNI sub-options.

When the MN receives the RA message, it creates an OMNI interface neighbor cache entry for each MSID that has confirmed MNP registration via the L2 address of this AR. If the MN connects to multiple ANETs, it records the additional L2 AR addresses in each MSID neighbor cache entry (i.e., as multilink neighbors). The MN then manages its underlying interfaces according to their states as follows:

- o When an underlying interface transitions to UP, the MN sends an RS over the underlying interface with an OMNI option. The OMNI option contains at least one Interface Attribute sub-option with values specific to this underlying interface, and may contain additional Interface Attributes specific to other underlying interfaces. The option also includes any MS-Register/Release sub-options.
- o When an underlying interface transitions to DOWN, the MN sends an RS or unsolicited NA message over any UP underlying interface with an OMNI option containing an Interface Attribute sub-option for



the DOWN underlying interface with Link set to '0'. The MN sends an RS when an acknowledgement is required, or an unsolicited NA when reliability is not thought to be a concern (e.g., if redundant transmissions are sent on multiple underlying interfaces).

- o When the Router Lifetime for a specific AR nears expiration, the MN sends an RS over the underlying interface to receive a fresh RA. If no RA is received, the MN can send RS messages to an alternate MSID in case the current MSID has failed. If no RS messages are received even after trying to contact alternate MSIDs, the MN marks the underlying interface as DOWN.
- o When a MN wishes to release from one or more current MSIDs, it sends an RS or unsolicited NA message over any UP underlying interfaces with an OMNI option with a Release MSID. Each MSID then withdraws the MNP from the routing/mapping system and informs the AR that the release was successful.
- o When all of a MNS underlying interfaces have transitioned to DOWN (or if the prefix registration lifetime expires), any associated MSEs withdraw the MNP the same as if they had received a message with a release indication.

The MN is responsible for retrying each RS exchange up to MAX\_RTR\_SOLICITATIONS times separated by RTR\_SOLICITATION\_INTERVAL seconds until an RA is received. If no RA is received over a an UP underlying interface (i.e., even after attempting to contact alternate MSEs), the MN declares this underlying interface as DOWN.

The IPv6 layer sees the OMNI interface as an ordinary IPv6 interface. Therefore, when the IPv6 layer sends an RS message the OMNI interface returns an internally-generated RA message as though the message originated from an IPv6 router. The internally-generated RA message contains configuration information that is consistent with the information received from the RAs generated by the MS. Whether the OMNI interface IPv6 ND messaging process is initiated from the receipt of an RS message from the IPv6 layer is an implementation matter. Some implementations may elect to defer the IPv6 ND messaging process until an RS is received from the IPv6 layer, while others may elect to initiate the process proactively. Still other deployments may elect to administratively disable the ordinary RS/RA messaging used by the IPv6 layer over the OMNI interface, since they are not required to drive the internal RS/RA processing. (Note that this same logic applies to IPv4 implementations that employ ICMP-based Router Discovery per [[RFC1256](#)].)



Note: The Router Lifetime value in RA messages indicates the time before which the MN must send another RS message over this underlying interface (e.g., 600 seconds), however that timescale may be significantly longer than the lifetime the MS has committed to retain the prefix registration (e.g., REACHABLETIME seconds). ARs are therefore responsible for keeping MS state alive on a shorter timescale than the MN is required to do on its own behalf.

Note: On multicast-capable underlying interfaces, MNs should send periodic unsolicited multicast NA messages and ARs should send periodic unsolicited multicast RA messages as "beacons" that can be heard by other nodes on the link. If a node fails to receive a beacon after a timeout value specific to the link, it can initiate a unicast exchange to test reachability.

### **12.1. Router Discovery in IP Multihop and IPv4-Only Access Networks**

On some ANET types a MN may be located multiple IP hops away from the nearest AR. Forwarding through IP multihop ANETs is conducted through the application of a routing protocol (e.g., a Mobile Ad-hoc Network (MANET) routing protocol over omni-directional wireless interfaces, an inter-domain routing protocol in an enterprise network, etc.). These ANETs could be either IPv6-enabled or IPv4-only, while IPv4-only ANETs could be either multicast-capable or unicast-only (note that for IPv4-only ANETs the following procedures apply for both single-hop and multihop cases).

A MN located potentially multiple ANET hops away from the nearest AR prepares an RS message with source address set to its OMNI LLA and with destination set to link-scoped All-Routers multicast the same as discussed above. For IPv6-enabled ANETs, the MN then encapsulates the message in an IPv6 header with source address set to the ULA corresponding to the LLA source address and with destination set to site-scoped All-Routers multicast (ff05::2)[[RFC4291](#)]. For IPv4-only ANETs, the MN instead encapsulates the RS message in an IPv4 header with source address set to the node's own IPv4 address. For multicast-capable IPv4-only ANETs, the MN then sets the destination address to the site-scoped IPv4 multicast address corresponding to link-scoped IPv6 All-Routers multicast [[RFC2529](#)]; for unicast-only IPv4-only ANETs, the MN instead sets the destination address to the unicast IPv4 address of an AR [[RFC5214](#)]. The MN then sends the encapsulated RS message via the ANET interface, where it will be forwarded by zero or more intermediate ANET hops.

When an intermediate ANET hop that participates in the routing protocol receives the encapsulated RS, it forwards the message according to its routing tables (note that an intermediate node could be a fixed infrastructure element or another MN). This process





repeats iteratively until the RS message is received by a penultimate ANET hop within single-hop communications range of an AR, which forwards the message to the AR.

When the AR receives the message, it decapsulates the RS and coordinates with the MS the same as for an ordinary link-local RS, since the inner Hop Limit will not have been decremented by the multihop forwarding process. The AR then prepares an RA message with source address set to its own LLA and destination address set to the LLA of the original MN, then encapsulates the message in an IPv4/IPv6 header with source address set to its own IPv4/ULA address and with destination set to the encapsulation source of the RS.

The AR then forwards the message to an ANET node within communications range, which forwards the message according to its routing tables to an intermediate node. The multihop forwarding process within the ANET continues repetitively until the message is delivered to the original MN, which decapsulates the message and performs autoconfiguration the same as if it had received the RA directly from the AR as an on-link neighbor.

Note: An alternate approach to multihop forwarding via IPv6 encapsulation would be to statelessly translate the IPv6 LLAs into ULAs and forward the messages without encapsulation. This would violate the [[RFC4861](#)] requirement that certain IPv6 ND messages must use link-local addresses and must not be accepted if received with Hop Limit less than 255. This document therefore advocates encapsulation since the overhead is nominal considering the infrequent nature and small size of IPv6 ND messages. Future documents may consider encapsulation avoidance through translation while updating [[RFC4861](#)].

Note: An alternate approach to multihop forwarding via IPv4 encapsulation would be to employ IPv6/IPv4 protocol translation. However, for IPv6 ND messages the OMNI LLA addresses would be truncated due to translation and the OMNI Router and Prefix Discovery services would not be able to function. The use of IPv4 encapsulation is therefore indicated.

## **12.2. MS-Register and MS-Release List Processing**

When a MN sends an RS message with an OMNI option via an underlying interface to an AR, the MN must convey its knowledge of its currently-associated MSEs. Initially, the MN will have no associated MSEs and should therefore include an MS-Register sub-option with the single MSID value 0 which requests the AR to select and assign an MSE. The AR will then return an RA message with source address set to the OMNI LLA containing the MSE of the selected MSE.



As the MN activates additional underlying interfaces, it can optionally include an MS-Register sub-option with MSID value 0, or with non-zero MSIDs for MSEs discovered from previous RS/RA exchanges. The MN will thus eventually begin to learn and manage its currently active set of MSEs, and can register with new MSEs or release from former MSEs with each successive RS/RA exchange. As the MN's MSE constituency grows, it alone is responsible for including or omitting MSIDs in the MS-Register/Release lists it sends in RS messages. The inclusion or omission of MSIDs determines the MN's interface to the MS and defines the manner in which MSEs will respond. The only limiting factor is that the MN should include no more than MAX\_MSID values in each list per each IPv6 ND message, and should avoid duplication of entries in each list unless it wants to increase likelihood of control message delivery.

When an AR receives an RS message sent by a MN with an OMNI option, the option will contain zero or more MS-Register and MS-Release sub-options containing MSIDs. After processing the OMNI option, the AR will have a list of zero or more MS-Register MSIDs and a list of zero or more of MS-Release MSIDs. The AR then processes the lists as follows:

- o For each list, retain the first MAX\_MSID values in the list and discard any additional MSIDs (i.e., even if there are duplicates within a list).
- o Next, for each MSID in the MS-Register list, remove all matching MSIDs from the MS-Release list.
- o Next, proceed according to whether the AR's own MSID or the value 0 appears in the MS-Register list as follows:
  - \* If yes, send an RA message directly back to the MN and send a proxy copy of the RS message to each additional MSID in the MS-Register list with the MS-Register/Release lists omitted. Then, send a uNA message to each MSID in the MS-Release list with the MS-Register/Release lists omitted and with an OMNI header with S/T-ifIndex set to 0.
  - \* If no, send a proxy copy of the RS message to each additional MSID in the MS-Register list with the MS-Register list omitted. For the first MSID, include the original MS-Release list; for all other MSIDs, omit the MS-Release list.

Each proxy copy of the RS message will include an OMNI option and encapsulation header with the ULA of the AR as the source and the ULA of the Register MSE as the destination. When the Register MSE receives the proxy RS message, if the message includes an MS-Release



list the MSE sends a uNA message to each additional MSID in the Release list. The Register MSE then sends an RA message back to the (Proxy) AR wrapped in an OMNI encapsulation header with source and destination addresses reversed, and with RA destination set to the LLA of the MN. When the AR receives this RA message, it sends a proxy copy of the RA to the MN.

Each uNA message (whether send by the first-hop AR or by a Register MSE) will include an OMNI option and an encapsulation header with the ULA of the Register MSE as the source and the ULA of the Release ME as the destination. The uNA informs the Release MSE that its previous relationship with the MN has been released and that the source of the uNA message is now registered. The Release MSE must then note that the subject MN of the uNA message is now "departed", and forward any subsequent packets destined to the MN to the Register MSE.

Note that it is not an error for the MS-Register/Release lists to include duplicate entries. If duplicates occur within a list, the the AR will generate multiple proxy RS and/or uNA messages - one for each copy of the duplicate entries.

### **13. Secure Redirection**

If the ANET link model is multiple access, the AR is responsible for assuring that address duplication cannot corrupt the neighbor caches of other nodes on the link. When the MN sends an RS message on a multiple access ANET link, the AR verifies that the MN is authorized to use the address and returns an RA with a non-zero Router Lifetime only if the MN is authorized.

After verifying MN authorization and returning an RA, the AR MAY return IPv6 ND Redirect messages to direct MNs located on the same ANET link to exchange packets directly without transiting the AR. In that case, the MNs can exchange packets according to their unicast L2 addresses discovered from the Redirect message instead of using the dogleg path through the AR. In some ANET links, however, such direct communications may be undesirable and continued use of the dogleg path through the AR may provide better performance. In that case, the AR can refrain from sending Redirects, and/or MNs can ignore them.

### **14. AR and MSE Resilience**

ANETs SHOULD deploy ARs in Virtual Router Redundancy Protocol (VRRP) [[RFC5798](#)] configurations so that service continuity is maintained even if one or more ARs fail. Using VRRP, the MN is unaware which of the (redundant) ARs is currently providing service, and any service



discontinuity will be limited to the failover time supported by VRRP. Widely deployed public domain implementations of VRRP are available.

MSEs SHOULD use high availability clustering services so that multiple redundant systems can provide coordinated response to failures. As with VRRP, widely deployed public domain implementations of high availability clustering services are available. Note that special-purpose and expensive dedicated hardware is not necessary, and public domain implementations can be used even between lightweight virtual machines in cloud deployments.

## **15. Detecting and Responding to MSE Failures**

In environments where fast recovery from MSE failure is required, ARs SHOULD use proactive Neighbor Unreachability Detection (NUD) in a manner that parallels Bidirectional Forwarding Detection (BFD) [[RFC5880](#)] to track MSE reachability. ARs can then quickly detect and react to failures so that cached information is re-established through alternate paths. Proactive NUD control messaging is carried only over well-connected ground domain networks (i.e., and not low-end ANET links such as aeronautical radios) and can therefore be tuned for rapid response.

ARs perform proactive NUD for MSEs for which there are currently active MNs on the ANET. If an MSE fails, ARs can quickly inform MNs of the outage by sending multicast RA messages on the ANET interface. The AR sends RA messages to MNs via the ANET interface with an OMNI option with a Release ID for the failed MSE, and with destination address set to All-Nodes multicast (ff02::1) [[RFC4291](#)].

The AR SHOULD send MAX\_FINAL\_RTR\_ADVERTISEMENTS RA messages separated by small delays [[RFC4861](#)]. Any MNs on the ANET interface that have been using the (now defunct) MSE will receive the RA messages and associate with a new MSE.

## **16. Transition Considerations**

When a MN connects to an ANET link for the first time, it sends an RS message with an OMNI option. If the first hop AR recognizes the option, it returns an RA with its MS OMNI LLA as the source, the MN OMNI LLA as the destination and with an OMNI option included. The MN then engages the AR according to the OMNI link model specified above. If the first hop AR is a legacy IPv6 router, however, it instead returns an RA message with no OMNI option and with a non-OMNI unicast source LLA as specified in [[RFC4861](#)]. In that case, the MN engages the ANET according to the legacy IPv6 link model and without the OMNI extensions specified in this document.





If the ANET link model is multiple access, there must be assurance that address duplication cannot corrupt the neighbor caches of other nodes on the link. When the MN sends an RS message on a multiple access ANET link with an OMNI LLA source address and an OMNI option, ARs that recognize the option ensure that the MN is authorized to use the address and return an RA with a non-zero Router Lifetime only if the MN is authorized. ARs that do not recognize the option instead return an RA that makes no statement about the MN's authorization to use the source address. In that case, the MN should perform Duplicate Address Detection to ensure that it does not interfere with other nodes on the link.

An alternative approach for multiple access ANET links to ensure isolation for MN / AR communications is through L2 address mappings as discussed in [Appendix C](#). This arrangement imparts a (virtual) point-to-point link model over the (physical) multiple access link.

## **17. OMNI Interfaces on the Open Internet**

OMNI interfaces configured over IPv6-enabled underlying interfaces on the open Internet without an OMNI-aware first-hop AR receive RA messages that do not include an OMNI option, while OMNI interfaces configured over IPv4-only underlying interfaces do not receive any (IPv6) RA messages at all. OMNI interfaces that receive RA messages without an OMNI option configure addresses, on-link prefixes, etc. on the underlying interface that received the RA according to standard IPv6 ND and address resolution conventions [[RFC4861](#)] [[RFC4862](#)]. OMNI interfaces configured over IPv4-only underlying interfaces configure IPv4 address information on the underlying interfaces using mechanisms such as DHCPv4 [[RFC2131](#)].

OMNI interfaces configured over underlying interfaces that connect to the open Internet can apply security services such as VPNs to connect to an MSE or establish a direct link to an MSE through some other means. In environments where an explicit VPN or direct link may be impractical, OMNI interfaces can instead use UDP/IP encapsulation per [[RFC6081](#)][[RFC4380](#)]. (Secure Neighbor Discovery (SEND) and Cryptographically Generated Addresses (CGA) [[RFC3971](#)][[RFC3972](#)] or other protocol-specific security services can also be used if additional authentication is necessary.)

After establishing a VPN or preparing for UDP/IP encapsulation, OMNI interfaces send control plane messages to interface with the MS. The control plane messages must be authenticated while data plane messages are delivered the same as for ordinary best-effort Internet traffic with basic source address-based data origin verification. Data plane communications via OMNI interfaces that connect over the open Internet without an explicit VPN should therefore employ



transport- or higher-layer security to ensure integrity and/or confidentiality.

When SEND/CGA are used over an open Internet underlying interfaces, each OMNI node configures a link-local CGA for use as the source address of IPv6 ND messages. The node then employs OMNI link encapsulation and sets the IPv6 source address of the OMNI header to the ULA corresponding to its OMNI LLA. Any Prefix Length values in the IPv6 ND message OMNI option then apply to the ULA found in the OMNI header, i.e., and not to the CGA found in the IPv6 ND message source address.

OMNI interfaces in the open Internet are often located behind Network Address Translators (NATs). The OMNI interface accommodates NAT traversal using UDP/IP encapsulation and the mechanisms discussed in [\[RFC6081\]](#)[\[RFC4380\]](#)[\[I-D.templin-intarea-6706bis\]](#).

## **18. Time-Varying MNPs**

In some use cases, it is desirable, beneficial and efficient for the MN to receive a constant MNP that travels with the MN wherever it moves. For example, this would allow air traffic controllers to easily track aircraft, etc. In other cases, however (e.g., intelligent transportation systems), the MN may be willing to sacrifice a modicum of efficiency in order to have time-varying MNPs that can be changed every so often to defeat adversarial tracking.

Prefix delegation services such as those discussed in [\[I-D.templin-6man-dhcpv6-ndopt\]](#) and [\[I-D.templin-intarea-6706bis\]](#) allow OMNI MNs that desire time-varying MNPs to obtain short-lived prefixes. In that case, the identity of the MN can be used as a prefix delegation seed (e.g., a DHCPv6 Device Unique Identifier (DUID) [\[RFC8415\]](#)). The MN would then be obligated to renumber its internal networks whenever its MNP (and therefore also its OMNI address) changes. This should not present a challenge for MNs with automated network renumbering services, however presents limits for the durations of ongoing sessions that would prefer to use a constant address.

When a MN wishes to invoke DHCPv6 Prefix Delegation (PD) services, it sets the source address of an RS message to fe80:: and includes a DUID sub-option and a desired Prefix Length value in the RS message OMNI option. When the first-hop AR receives the RS message, it performs a PD exchange with the DHCPv6 service to obtain an IPv6 MNP of the requested length then returns an RA message with the OMNI LLA corresponding to the MNP as the destination address. When the MN receives the RA message, it provisions the PD to its downstream-



attached networks and begins using the OMNI LLA in subsequent IPv6 ND messaging.

**19. IANA Considerations**

The IANA is instructed to allocate an official Type number TBD from the registry "IPv6 Neighbor Discovery Option Formats" for the OMNI option. Implementations set Type to 253 as an interim value [[RFC4727](#)].

The IANA is instructed to assign a new Code value "1" in the "ICMPv6 Code Fields: Type 2 - Packet Too Big" registry. The registry should read as follows:

Code	Name	Reference
---	----	-----
0	Diagnostic Packet Too Big	[ <a href="#">RFC4443</a> ]
1	Advisory Packet Too Big	[RFCXXXX]

Figure 16: OMNI Option Sub-Type Values

The IANA is instructed to allocate one Ethernet unicast address TBD2 (suggest 00-00-5E-00-52-14 [[RFC5214](#)]) in the registry "IANA Ethernet Address Block - Unicast Use".

The OMNI option also defines an 8-bit Sub-Type field, for which IANA is instructed to create and maintain a new registry entitled "OMNI option Sub-Type values". Initial values for the OMNI option Sub-Type values registry are given below; future assignments are to be made through Expert Review [[RFC8126](#)].

Value	Sub-Type name	Reference
-----	-----	-----
0	Pad1	[RFCXXXX]
1	PadN	[RFCXXXX]
2	Interface Attributes	[RFCXXXX]
3	Traffic Selector	[RFCXXXX]
4	MS-Register	[RFCXXXX]
5	MS-Release	[RFCXXXX]
6	Network Access Identifier	[RFCXXXX]
7	Geo Coordinates	[RFCXXXX]
8	DHCP Unique Identifier (DUID)	[RFCXXXX]
9-252	Unassigned	
253-254	Experimental	[RFCXXXX]
255	Reserved	[RFCXXXX]

Figure 17: OMNI Option Sub-Type Values



## **20. Security Considerations**

Security considerations for IPv4 [[RFC0791](#)], IPv6 [[RFC8200](#)] and IPv6 Neighbor Discovery [[RFC4861](#)] apply. OMNI interface IPv6 ND messages SHOULD include Nonce and Timestamp options [[RFC3971](#)] when transaction confirmation and/or time synchronization is needed.

OMNI interfaces configured over secured ANET interfaces inherit the physical and/or link-layer security properties of the connected ANETs. OMNI interfaces configured over open INET interfaces can use symmetric securing services such as VPNs or can by some other means establish a direct link. When a VPN or direct link may be impractical, however, an asymmetric security service such as SEcure Neighbor Discovery (SEND) [[RFC3971](#)] with Cryptographically Generated Addresses (CGAs) [[RFC3972](#)], the authentication option specified in [[RFC4380](#)] or other protocol control message security mechanisms may be necessary. While the OMNI link protects control plane messaging, applications must still employ end-to-end transport- or higher-layer security services to protect the data plane.

The Mobility Service MUST provide strong network layer security for control plane messages and forwarding path integrity for data plane messages. In one example, the AERO service [[I-D.templin-intarea-6706bis](#)] constructs a spanning tree between mobility service elements and secures the links in the spanning tree with network layer security mechanisms such as IPsec [[RFC4301](#)] or Wireguard. Control plane messages are then constrained to travel only over the secured spanning tree paths and are therefore protected from attack or eavesdropping. Since data plane messages can travel over route optimized paths that do not strictly follow the spanning tree, however, end-to-end transport- or higher-layer security services are still required.

Security considerations for specific access network interface types are covered under the corresponding IP-over-(foo) specification (e.g., [[RFC2464](#)], [[RFC2492](#)], etc.).

Security considerations for IPv6 fragmentation and reassembly are discussed in [Section 5.1](#).

## **21. Implementation Status**

Draft -29 is implemented in the recently tagged AERO/OMNI 3.0.0 internal release, and Draft -30 is now tagged as the AERO/OMNI 3.0.1. Newer specification versions will be tagged in upcoming releases. First public release expected before the end of 2020.





## **22. Acknowledgements**

The first version of this document was prepared per the consensus decision at the 7th Conference of the International Civil Aviation Organization (ICAO) Working Group-I Mobility Subgroup on March 22, 2019. Consensus to take the document forward to the IETF was reached at the 9th Conference of the Mobility Subgroup on November 22, 2019. Attendees and contributors included: Guray Acar, Danny Bharj, Francois D'Humieres, Pavel Drasil, Nikos Fistas, Giovanni Garofolo, Bernhard Haindl, Vaughn Maiolla, Tom McParland, Victor Moreno, Madhu Niraula, Brent Phillips, Liviu Popescu, Jacky Pouzet, Aloke Roy, Greg Saccone, Robert Segers, Michal Skorepa, Michel Solery, Stephane Tamalet, Fred Templin, Jean-Marc Vacher, Bela Varkonyi, Tony Whyman, Fryderyk Wrobel and Dongsong Zeng.

The following individuals are acknowledged for their useful comments: Michael Matyas, Madhu Niraula, Michael Richardson, Greg Saccone, Stephane Tamalet, Eric Vyncke. Pavel Drasil, Zdenek Jaron and Michal Skorepa are recognized for their many helpful ideas and suggestions. Madhuri Madhava Badgandi, Katherine Tran, and Vijayasathy Rajagopalan are acknowledged for their hard work on the implementation and insights that led to improvements to the spec.

This work is aligned with the NASA Safe Autonomous Systems Operation (SASO) program under NASA contract number NNA16BD84C.

This work is aligned with the FAA as per the SE2025 contract number DTFWA-15-D-00030.

## **23. References**

### **23.1. Normative References**

- [RFC0791] Postel, J., "Internet Protocol", STD 5, [RFC 791](#), DOI 10.17487/RFC0791, September 1981, <<https://www.rfc-editor.org/info/rfc791>>.
- [RFC2119] Bradner, S., "Key words for use in RFCs to Indicate Requirement Levels", [BCP 14](#), [RFC 2119](#), DOI 10.17487/RFC2119, March 1997, <<https://www.rfc-editor.org/info/rfc2119>>.
- [RFC2474] Nichols, K., Blake, S., Baker, F., and D. Black, "Definition of the Differentiated Services Field (DS Field) in the IPv4 and IPv6 Headers", [RFC 2474](#), DOI 10.17487/RFC2474, December 1998, <<https://www.rfc-editor.org/info/rfc2474>>.



- [RFC3971] Arkko, J., Ed., Kempf, J., Zill, B., and P. Nikander, "SEcure Neighbor Discovery (SEND)", [RFC 3971](#), DOI 10.17487/RFC3971, March 2005, <<https://www.rfc-editor.org/info/rfc3971>>.
- [RFC3972] Aura, T., "Cryptographically Generated Addresses (CGA)", [RFC 3972](#), DOI 10.17487/RFC3972, March 2005, <<https://www.rfc-editor.org/info/rfc3972>>.
- [RFC4191] Draves, R. and D. Thaler, "Default Router Preferences and More-Specific Routes", [RFC 4191](#), DOI 10.17487/RFC4191, November 2005, <<https://www.rfc-editor.org/info/rfc4191>>.
- [RFC4193] Hinden, R. and B. Haberman, "Unique Local IPv6 Unicast Addresses", [RFC 4193](#), DOI 10.17487/RFC4193, October 2005, <<https://www.rfc-editor.org/info/rfc4193>>.
- [RFC4291] Hinden, R. and S. Deering, "IP Version 6 Addressing Architecture", [RFC 4291](#), DOI 10.17487/RFC4291, February 2006, <<https://www.rfc-editor.org/info/rfc4291>>.
- [RFC4443] Conta, A., Deering, S., and M. Gupta, Ed., "Internet Control Message Protocol (ICMPv6) for the Internet Protocol Version 6 (IPv6) Specification", STD 89, [RFC 4443](#), DOI 10.17487/RFC4443, March 2006, <<https://www.rfc-editor.org/info/rfc4443>>.
- [RFC4727] Fenner, B., "Experimental Values In IPv4, IPv6, ICMPv4, ICMPv6, UDP, and TCP Headers", [RFC 4727](#), DOI 10.17487/RFC4727, November 2006, <<https://www.rfc-editor.org/info/rfc4727>>.
- [RFC4861] Narten, T., Nordmark, E., Simpson, W., and H. Soliman, "Neighbor Discovery for IP version 6 (IPv6)", [RFC 4861](#), DOI 10.17487/RFC4861, September 2007, <<https://www.rfc-editor.org/info/rfc4861>>.
- [RFC4862] Thomson, S., Narten, T., and T. Jinmei, "IPv6 Stateless Address Autoconfiguration", [RFC 4862](#), DOI 10.17487/RFC4862, September 2007, <<https://www.rfc-editor.org/info/rfc4862>>.
- [RFC6088] Tsirtsis, G., Giarreta, G., Soliman, H., and N. Montavont, "Traffic Selectors for Flow Bindings", [RFC 6088](#), DOI 10.17487/RFC6088, January 2011, <<https://www.rfc-editor.org/info/rfc6088>>.



- [RFC8028] Baker, F. and B. Carpenter, "First-Hop Router Selection by Hosts in a Multi-Prefix Network", [RFC 8028](#), DOI 10.17487/RFC8028, November 2016, <<https://www.rfc-editor.org/info/rfc8028>>.
- [RFC8174] Leiba, B., "Ambiguity of Uppercase vs Lowercase in [RFC 2119](#) Key Words", [BCP 14](#), [RFC 8174](#), DOI 10.17487/RFC8174, May 2017, <<https://www.rfc-editor.org/info/rfc8174>>.
- [RFC8200] Deering, S. and R. Hinden, "Internet Protocol, Version 6 (IPv6) Specification", STD 86, [RFC 8200](#), DOI 10.17487/RFC8200, July 2017, <<https://www.rfc-editor.org/info/rfc8200>>.
- [RFC8201] McCann, J., Deering, S., Mogul, J., and R. Hinden, Ed., "Path MTU Discovery for IP version 6", STD 87, [RFC 8201](#), DOI 10.17487/RFC8201, July 2017, <<https://www.rfc-editor.org/info/rfc8201>>.
- [RFC8415] Mrugalski, T., Siodelski, M., Volz, B., Yourtchenko, A., Richardson, M., Jiang, S., Lemon, T., and T. Winters, "Dynamic Host Configuration Protocol for IPv6 (DHCPv6)", [RFC 8415](#), DOI 10.17487/RFC8415, November 2018, <<https://www.rfc-editor.org/info/rfc8415>>.

### **23.2. Informative References**

- [I-D.ietf-intarea-tunnels]  
Touch, J. and M. Townsley, "IP Tunnels in the Internet Architecture", [draft-ietf-intarea-tunnels-10](#) (work in progress), September 2019.
- [I-D.templin-6man-dhcpv6-ndopt]  
Templin, F., "A Unified Stateful/Stateless Configuration Service for IPv6", [draft-templin-6man-dhcpv6-ndopt-10](#) (work in progress), June 2020.
- [I-D.templin-intarea-6706bis]  
Templin, F., "Asymmetric Extended Route Optimization (AERO)", [draft-templin-intarea-6706bis-65](#) (work in progress), September 2020.
- [RFC1122] Braden, R., Ed., "Requirements for Internet Hosts - Communication Layers", STD 3, [RFC 1122](#), DOI 10.17487/RFC1122, October 1989, <<https://www.rfc-editor.org/info/rfc1122>>.



- [RFC1191] Mogul, J. and S. Deering, "Path MTU discovery", [RFC 1191](#), DOI 10.17487/RFC1191, November 1990, <<https://www.rfc-editor.org/info/rfc1191>>.
- [RFC1256] Deering, S., Ed., "ICMP Router Discovery Messages", [RFC 1256](#), DOI 10.17487/RFC1256, September 1991, <<https://www.rfc-editor.org/info/rfc1256>>.
- [RFC2131] Droms, R., "Dynamic Host Configuration Protocol", [RFC 2131](#), DOI 10.17487/RFC2131, March 1997, <<https://www.rfc-editor.org/info/rfc2131>>.
- [RFC2225] Laubach, M. and J. Halpern, "Classical IP and ARP over ATM", [RFC 2225](#), DOI 10.17487/RFC2225, April 1998, <<https://www.rfc-editor.org/info/rfc2225>>.
- [RFC2464] Crawford, M., "Transmission of IPv6 Packets over Ethernet Networks", [RFC 2464](#), DOI 10.17487/RFC2464, December 1998, <<https://www.rfc-editor.org/info/rfc2464>>.
- [RFC2473] Conta, A. and S. Deering, "Generic Packet Tunneling in IPv6 Specification", [RFC 2473](#), DOI 10.17487/RFC2473, December 1998, <<https://www.rfc-editor.org/info/rfc2473>>.
- [RFC2492] Armitage, G., Schuster, P., and M. Jork, "IPv6 over ATM Networks", [RFC 2492](#), DOI 10.17487/RFC2492, January 1999, <<https://www.rfc-editor.org/info/rfc2492>>.
- [RFC2529] Carpenter, B. and C. Jung, "Transmission of IPv6 over IPv4 Domains without Explicit Tunnels", [RFC 2529](#), DOI 10.17487/RFC2529, March 1999, <<https://www.rfc-editor.org/info/rfc2529>>.
- [RFC2863] McCloghrie, K. and F. Kastenholz, "The Interfaces Group MIB", [RFC 2863](#), DOI 10.17487/RFC2863, June 2000, <<https://www.rfc-editor.org/info/rfc2863>>.
- [RFC3692] Narten, T., "Assigning Experimental and Testing Numbers Considered Useful", [BCP 82](#), [RFC 3692](#), DOI 10.17487/RFC3692, January 2004, <<https://www.rfc-editor.org/info/rfc3692>>.
- [RFC3810] Vida, R., Ed. and L. Costa, Ed., "Multicast Listener Discovery Version 2 (MLDv2) for IPv6", [RFC 3810](#), DOI 10.17487/RFC3810, June 2004, <<https://www.rfc-editor.org/info/rfc3810>>.





- [RFC3819] Karn, P., Ed., Bormann, C., Fairhurst, G., Grossman, D., Ludwig, R., Mahdavi, J., Montenegro, G., Touch, J., and L. Wood, "Advice for Internet Subnetwork Designers", [BCP 89](#), [RFC 3819](#), DOI 10.17487/RFC3819, July 2004, <<https://www.rfc-editor.org/info/rfc3819>>.
- [RFC3879] Huitema, C. and B. Carpenter, "Deprecating Site Local Addresses", [RFC 3879](#), DOI 10.17487/RFC3879, September 2004, <<https://www.rfc-editor.org/info/rfc3879>>.
- [RFC4301] Kent, S. and K. Seo, "Security Architecture for the Internet Protocol", [RFC 4301](#), DOI 10.17487/RFC4301, December 2005, <<https://www.rfc-editor.org/info/rfc4301>>.
- [RFC4380] Huitema, C., "Teredo: Tunneling IPv6 over UDP through Network Address Translations (NATs)", [RFC 4380](#), DOI 10.17487/RFC4380, February 2006, <<https://www.rfc-editor.org/info/rfc4380>>.
- [RFC4389] Thaler, D., Talwar, M., and C. Patel, "Neighbor Discovery Proxies (ND Proxy)", [RFC 4389](#), DOI 10.17487/RFC4389, April 2006, <<https://www.rfc-editor.org/info/rfc4389>>.
- [RFC4541] Christensen, M., Kimball, K., and F. Solensky, "Considerations for Internet Group Management Protocol (IGMP) and Multicast Listener Discovery (MLD) Snooping Switches", [RFC 4541](#), DOI 10.17487/RFC4541, May 2006, <<https://www.rfc-editor.org/info/rfc4541>>.
- [RFC4605] Fenner, B., He, H., Haberman, B., and H. Sandick, "Internet Group Management Protocol (IGMP) / Multicast Listener Discovery (MLD)-Based Multicast Forwarding ("IGMP/MLD Proxying")", [RFC 4605](#), DOI 10.17487/RFC4605, August 2006, <<https://www.rfc-editor.org/info/rfc4605>>.
- [RFC4821] Mathis, M. and J. Heffner, "Packetization Layer Path MTU Discovery", [RFC 4821](#), DOI 10.17487/RFC4821, March 2007, <<https://www.rfc-editor.org/info/rfc4821>>.
- [RFC4963] Heffner, J., Mathis, M., and B. Chandler, "IPv4 Reassembly Errors at High Data Rates", [RFC 4963](#), DOI 10.17487/RFC4963, July 2007, <<https://www.rfc-editor.org/info/rfc4963>>.
- [RFC5175] Haberman, B., Ed. and R. Hinden, "IPv6 Router Advertisement Flags Option", [RFC 5175](#), DOI 10.17487/RFC5175, March 2008, <<https://www.rfc-editor.org/info/rfc5175>>.



- [RFC5213] Gundavelli, S., Ed., Leung, K., Devarapalli, V., Chowdhury, K., and B. Patil, "Proxy Mobile IPv6", [RFC 5213](#), DOI 10.17487/RFC5213, August 2008, <<https://www.rfc-editor.org/info/rfc5213>>.
- [RFC5214] Templin, F., Gleeson, T., and D. Thaler, "Intra-Site Automatic Tunnel Addressing Protocol (ISATAP)", [RFC 5214](#), DOI 10.17487/RFC5214, March 2008, <<https://www.rfc-editor.org/info/rfc5214>>.
- [RFC5558] Templin, F., Ed., "Virtual Enterprise Traversal (VET)", [RFC 5558](#), DOI 10.17487/RFC5558, February 2010, <<https://www.rfc-editor.org/info/rfc5558>>.
- [RFC5798] Nadas, S., Ed., "Virtual Router Redundancy Protocol (VRRP) Version 3 for IPv4 and IPv6", [RFC 5798](#), DOI 10.17487/RFC5798, March 2010, <<https://www.rfc-editor.org/info/rfc5798>>.
- [RFC5880] Katz, D. and D. Ward, "Bidirectional Forwarding Detection (BFD)", [RFC 5880](#), DOI 10.17487/RFC5880, June 2010, <<https://www.rfc-editor.org/info/rfc5880>>.
- [RFC6081] Thaler, D., "Teredo Extensions", [RFC 6081](#), DOI 10.17487/RFC6081, January 2011, <<https://www.rfc-editor.org/info/rfc6081>>.
- [RFC6355] Narten, T. and J. Johnson, "Definition of the UUID-Based DHCPv6 Unique Identifier (DUID-UUID)", [RFC 6355](#), DOI 10.17487/RFC6355, August 2011, <<https://www.rfc-editor.org/info/rfc6355>>.
- [RFC6543] Gundavelli, S., "Reserved IPv6 Interface Identifier for Proxy Mobile IPv6", [RFC 6543](#), DOI 10.17487/RFC6543, May 2012, <<https://www.rfc-editor.org/info/rfc6543>>.
- [RFC7084] Singh, H., Beebe, W., Donley, C., and B. Stark, "Basic Requirements for IPv6 Customer Edge Routers", [RFC 7084](#), DOI 10.17487/RFC7084, November 2013, <<https://www.rfc-editor.org/info/rfc7084>>.
- [RFC7421] Carpenter, B., Ed., Chown, T., Gont, F., Jiang, S., Petrescu, A., and A. Yourtchenko, "Analysis of the 64-bit Boundary in IPv6 Addressing", [RFC 7421](#), DOI 10.17487/RFC7421, January 2015, <<https://www.rfc-editor.org/info/rfc7421>>.



- [RFC7542] DeKok, A., "The Network Access Identifier", [RFC 7542](#), DOI 10.17487/RFC7542, May 2015, <<https://www.rfc-editor.org/info/rfc7542>>.
- [RFC7739] Gont, F., "Security Implications of Predictable Fragment Identification Values", [RFC 7739](#), DOI 10.17487/RFC7739, February 2016, <<https://www.rfc-editor.org/info/rfc7739>>.
- [RFC7847] Melia, T., Ed. and S. Gundavelli, Ed., "Logical-Interface Support for IP Hosts with Multi-Access Support", [RFC 7847](#), DOI 10.17487/RFC7847, May 2016, <<https://www.rfc-editor.org/info/rfc7847>>.
- [RFC8126] Cotton, M., Leiba, B., and T. Narten, "Guidelines for Writing an IANA Considerations Section in RFCs", [BCP 26](#), [RFC 8126](#), DOI 10.17487/RFC8126, June 2017, <<https://www.rfc-editor.org/info/rfc8126>>.
- [RFC8402] Filsfils, C., Ed., Previdi, S., Ed., Ginsberg, L., Decraene, B., Litkowski, S., and R. Shakir, "Segment Routing Architecture", [RFC 8402](#), DOI 10.17487/RFC8402, July 2018, <<https://www.rfc-editor.org/info/rfc8402>>.
- [RFC8754] Filsfils, C., Ed., Dukes, D., Ed., Previdi, S., Leddy, J., Matsushima, S., and D. Voyer, "IPv6 Segment Routing Header (SRH)", [RFC 8754](#), DOI 10.17487/RFC8754, March 2020, <<https://www.rfc-editor.org/info/rfc8754>>.
- [RFC8900] Bonica, R., Baker, F., Huston, G., Hinden, R., Troan, O., and F. Gont, "IP Fragmentation Considered Fragile", [BCP 230](#), [RFC 8900](#), DOI 10.17487/RFC8900, September 2020, <<https://www.rfc-editor.org/info/rfc8900>>.

## **Appendix A. Interface Attribute Heuristic Bitmap Encoding**

Adaptation of the OMNI option Interface Attributes Heuristic Bitmap encoding to specific Internetworks such as the Aeronautical Telecommunications Network with Internet Protocol Services (ATN/IPS) may include link selection preferences based on other traffic classifiers (e.g., transport port numbers, etc.) in addition to the existing DSCP-based preferences. Nodes on specific Internetworks maintain a map of traffic classifiers to additional P[\*] preference fields beyond the first 64. For example, TCP port 22 maps to P[67], TCP port 443 maps to P[70], UDP port 8060 maps to P[76], etc.

Implementations use Simplex or Indexed encoding formats for P[\*] encoding in order to encode a given set of traffic classifiers in the most efficient way. Some use cases may be more efficiently coded



using Simplex form, while others may be more efficient using Indexed. Once a format is selected for preparation of a single Interface Attribute the same format must be used for the entire Interface Attribute sub-option. Different sub-options may use different formats.

The following figures show coding examples for various Simplex and Indexed formats:

```

      0              1              2              3
      0 1 2 3 4 5 6 7 8 9 0 1 2 3 4 5 6 7 8 9 0 1 2 3 4 5 6 7 8 9 0 1
+-----+-----+-----+-----+-----+-----+-----+-----+
| Sub-Type=2 | Sub-length=N | ifIndex   | ifType   |
+-----+-----+-----+-----+-----+-----+-----+-----+
| Provider ID | Link  |R| APS | Bitmap(0)=0xff|P00|P01|P02|P03|
+-----+-----+-----+-----+-----+-----+-----+-----+
|P04|P05|P06|P07|P08|P09|P10|P11|P12|P13|P14|P15|P16|P17|P18|P19|
+-----+-----+-----+-----+-----+-----+-----+-----+
|P20|P21|P22|P23|P24|P25|P26|P27|P28|P29|P30|P31| Bitmap(1)=0xff|
+-----+-----+-----+-----+-----+-----+-----+-----+
|P32|P33|P34|P35|P36|P37|P38|P39|P40|P41|P42|P43|P44|P45|P46|P47|
+-----+-----+-----+-----+-----+-----+-----+-----+
|P48|P49|P50|P51|P52|P53|P54|P55|P56|P57|P58|P59|P60|P61|P62|P63|
+-----+-----+-----+-----+-----+-----+-----+-----+
| Bitmap(2)=0xff|P64|P65|P67|P68| ...
+-----+-----+-----+-----+-----+-----+-----+-----+

```

Figure 18: Example 1: Dense Simplex Encoding





```

0          1          2          3
0 1 2 3 4 5 6 7 8 9 0 1 2 3 4 5 6 7 8 9 0 1 2 3 4 5 6 7 8 9 0 1
+--+--+--+--+--+--+--+--+--+--+--+--+--+--+--+--+--+--+--+--+--+--+
|  Sub-Type=2  |  Sub-length=N  |  ifIndex  |  ifType  |
+--+--+--+--+--+--+--+--+--+--+--+--+--+--+--+--+--+--+--+--+--+--+
|  Provider ID  |  Link  |R| APS  |  Bitmap(0)=0x00|  Bitmap(1)=0x0f|
+--+--+--+--+--+--+--+--+--+--+--+--+--+--+--+--+--+--+--+--+--+--+
|P48|P49|P50|P51|P52|P53|P54|P55|P56|P57|P58|P59|P60|P61|P62|P63|
+--+--+--+--+--+--+--+--+--+--+--+--+--+--+--+--+--+--+--+--+--+--+
|  Bitmap(2)=0x00|  Bitmap(3)=0x00|  Bitmap(4)=0x00|  Bitmap(5)=0x00|
+--+--+--+--+--+--+--+--+--+--+--+--+--+--+--+--+--+--+--+--+--+--+
|  Bitmap(6)=0xf0|192|193|194|195|196|197|198|199|200|201|202|203|
+--+--+--+--+--+--+--+--+--+--+--+--+--+--+--+--+--+--+--+--+--+--+
|204|205|206|207|  Bitmap(7)=0x00|  Bitmap(8)=0x0f|272|273|274|275|
+--+--+--+--+--+--+--+--+--+--+--+--+--+--+--+--+--+--+--+--+--+--+
|276|277|278|279|280|281|282|283|284|285|286|287|  Bitmap(9)=0x00|
+--+--+--+--+--+--+--+--+--+--+--+--+--+--+--+--+--+--+--+--+--+--+
|Bitmap(10)=0x00| ...
+--+--+--+--+--+--+--+--+--+--+

```

Figure 19: Example 2: Sparse Simplex Encoding

```

0          1          2          3
0 1 2 3 4 5 6 7 8 9 0 1 2 3 4 5 6 7 8 9 0 1 2 3 4 5 6 7 8 9 0 1
+--+--+--+--+--+--+--+--+--+--+--+--+--+--+--+--+--+--+--+--+--+--+
|  Sub-Type=2  |  Sub-length=N  |  ifIndex  |  ifType  |
+--+--+--+--+--+--+--+--+--+--+--+--+--+--+--+--+--+--+--+--+--+--+
|  Provider ID  |  Link  |R| APS  |  Index = 0x00 |  Bitmap = 0x80 |
+--+--+--+--+--+--+--+--+--+--+--+--+--+--+--+--+--+--+--+--+--+--+
|P00|P01|P02|P03|  Index = 0x01 |  Bitmap = 0x01 |P60|P61|P62|P63|
+--+--+--+--+--+--+--+--+--+--+--+--+--+--+--+--+--+--+--+--+--+--+
|  Index = 0x10 |  Bitmap = 0x80 |512|513|514|515|  Index = 0x18 |
+--+--+--+--+--+--+--+--+--+--+--+--+--+--+--+--+--+--+--+--+--+--+
|  Bitmap = 0x01 |796|797|798|799| ...
+--+--+--+--+--+--+--+--+--+--+

```

Figure 20: Example 3: Indexed Encoding

**Appendix B. VDL Mode 2 Considerations**

ICAO Doc 9776 is the "Technical Manual for VHF Data Link Mode 2" (VDLM2) that specifies an essential radio frequency data link service for aircraft and ground stations in worldwide civil aviation air traffic management. The VDLM2 link type is "multicast capable" [RFC4861], but with considerable differences from common multicast links such as Ethernet and IEEE 802.11.



First, the VDLM2 link data rate is only 31.5Kbps - multiple orders of magnitude less than most modern wireless networking gear. Second, due to the low available link bandwidth only VDLM2 ground stations (i.e., and not aircraft) are permitted to send broadcasts, and even so only as compact layer 2 "beacons". Third, aircraft employ the services of ground stations by performing unicast RS/RA exchanges upon receipt of beacons instead of listening for multicast RA messages and/or sending multicast RS messages.

This beacon-oriented unicast RS/RA approach is necessary to conserve the already-scarce available link bandwidth. Moreover, since the numbers of beaconing ground stations operating within a given spatial range must be kept as sparse as possible, it would not be feasible to have different classes of ground stations within the same region observing different protocols. It is therefore highly desirable that all ground stations observe a common language of RS/RA as specified in this document.

Note that links of this nature may benefit from compression techniques that reduce the bandwidth necessary for conveying the same amount of data. The IETF lpwan working group is considering possible alternatives: [<https://datatracker.ietf.org/wg/lpwan/documents>].

### **Appendix C. MN / AR Isolation Through L2 Address Mapping**

Per [[RFC4861](#)], IPv6 ND messages may be sent to either a multicast or unicast link-scoped IPv6 destination address. However, IPv6 ND messaging should be coordinated between the MN and AR only without invoking other nodes on the ANET. This implies that MN / AR control messaging should be isolated and not overheard by other nodes on the link.

To support MN / AR isolation on some ANET links, ARs can maintain an OMNI-specific unicast L2 address ("MSADDR"). For Ethernet-compatible ANETs, this specification reserves one Ethernet unicast address TBD2 (see: [Section 19](#)). For non-Ethernet statically-addressed ANETs, MSADDR is reserved per the assigned numbers authority for the ANET addressing space. For still other ANETs, MSADDR may be dynamically discovered through other means, e.g., L2 beacons.

MNs map the L3 addresses of all IPv6 ND messages they send (i.e., both multicast and unicast) to MSADDR instead of to an ordinary unicast or multicast L2 address. In this way, all of the MN's IPv6 ND messages will be received by ARs that are configured to accept packets destined to MSADDR. Note that multiple ARs on the link could be configured to accept packets destined to MSADDR, e.g., as a basis for supporting redundancy.



Therefore, ARs must accept and process packets destined to MSADDR, while all other devices must not process packets destined to MSADDR. This model has well-established operational experience in Proxy Mobile IPv6 (PMIP) [[RFC5213](#)][RFC6543].

#### **Appendix D. Change Log**

<< RFC Editor - remove prior to publication >>

Differences from [draft-templin-6man-omni-interface-35](#) to [draft-templin-6man-omni-interface-36](#):

- o Major clarifications on aspects such as "hard/soft" PTB error messages
- o Made generic so that either IP protocol version (IPv4 or IPv6) can be used in the data plane.

Differences from [draft-templin-6man-omni-interface-31](#) to [draft-templin-6man-omni-interface-32](#):

- o MTU
- o Support for multi-hop ANETS such as ISATAP.

Differences from [draft-templin-6man-omni-interface-29](#) to [draft-templin-6man-omni-interface-30](#):

- o Moved link-layer addressing information into the OMNI option on a per-ifIndex basis
- o Renamed "ifIndex-tuple" to "Interface Attributes"

Differences from [draft-templin-6man-omni-interface-27](#) to [draft-templin-6man-omni-interface-28](#):

- o Updates based on implementation experience.

Differences from [draft-templin-6man-omni-interface-25](#) to [draft-templin-6man-omni-interface-26](#):

- o Further clarification on "aggregate" RA messages.
- o Expanded Security Considerations to discuss expectations for security in the Mobility Service.

Differences from [draft-templin-6man-omni-interface-20](#) to [draft-templin-6man-omni-interface-21](#):



- o Safety-Based Multilink (SBM) and Performance-Based Multilink (PBM).

Differences from [draft-templin-6man-omni-interface-18](#) to [draft-templin-6man-omni-interface-19](#):

- o SEND/CGA.

Differences from [draft-templin-6man-omni-interface-17](#) to [draft-templin-6man-omni-interface-18](#):

- o Teredo

Differences from [draft-templin-6man-omni-interface-14](#) to [draft-templin-6man-omni-interface-15](#):

- o Prefix length discussions removed.

Differences from [draft-templin-6man-omni-interface-12](#) to [draft-templin-6man-omni-interface-13](#):

- o Teredo

Differences from [draft-templin-6man-omni-interface-11](#) to [draft-templin-6man-omni-interface-12](#):

- o Major simplifications and clarifications on MTU and fragmentation.
- o Document now updates [RFC4443](#) and [RFC8201](#).

Differences from [draft-templin-6man-omni-interface-10](#) to [draft-templin-6man-omni-interface-11](#):

- o Removed /64 assumption, resulting in new OMNI address format.

Differences from [draft-templin-6man-omni-interface-07](#) to [draft-templin-6man-omni-interface-08](#):

- o OMNI MNs in the open Internet

Differences from [draft-templin-6man-omni-interface-06](#) to [draft-templin-6man-omni-interface-07](#):

- o Brought back L2 MSADDR mapping text for MN / AR isolation based on L2 addressing.
- o Expanded "Transition Considerations".





Differences from [draft-templin-6man-omni-interface-05](#) to [draft-templin-6man-omni-interface-06](#):

- o Brought back OMNI option "R" flag, and discussed its use.

Differences from [draft-templin-6man-omni-interface-04](#) to [draft-templin-6man-omni-interface-05](#):

- o Transition considerations, and overhaul of RS/RA addressing with the inclusion of MSE addresses within the OMNI option instead of as RS/RA addresses (developed under FAA SE2025 contract number DTFAWA-15-D-00030).

Differences from [draft-templin-6man-omni-interface-02](#) to [draft-templin-6man-omni-interface-03](#):

- o Added "advisory PTB messages" under FAA SE2025 contract number DTFAWA-15-D-00030.

Differences from [draft-templin-6man-omni-interface-01](#) to [draft-templin-6man-omni-interface-02](#):

- o Removed "Primary" flag and supporting text.
- o Clarified that "Router Lifetime" applies to each ANET interface independently, and that the union of all ANET interface Router Lifetimes determines MSE lifetime.

Differences from [draft-templin-6man-omni-interface-00](#) to [draft-templin-6man-omni-interface-01](#):

- o "All-MSEs" OMNI LLA defined. Also reserved fe80::ff00:0000/104 for future use (most likely as "pseudo-multicast").
- o Non-normative discussion of alternate OMNI LLA construction form made possible if the 64-bit assumption were relaxed.

First draft version ([draft-templin-atn-aero-interface-00](#)):

- o Draft based on consensus decision of ICAO Working Group I Mobility Subgroup March 22, 2019.

Authors' Addresses



Fred L. Templin (editor)  
The Boeing Company  
P.O. Box 3707  
Seattle, WA 98124  
USA

Email: [fltemplin@acm.org](mailto:fltemplin@acm.org)

Tony Whyman  
MWA Ltd c/o Inmarsat Global Ltd  
99 City Road  
London EC1Y 1AX  
England

Email: [tony.whyman@mccallumwhyman.com](mailto:tony.whyman@mccallumwhyman.com)

