

# LISP PubSub

draft-rodrigueznatal-lisp-pubsub-01

A. Rodriguez-Natal, V. Ermagan, J. Leong, F. Maino, A. Cabellos, S. Barkai, D. Farinacci, M. Boucadair, C. Jacquenet, S. Secci

# Publish/Subscribe Overview

- Map-Servers configured in proxy-reply mode
- xTRs provisioned with unique xTR-ID
- Subscription piggybacked on the Map-Request (no new messages)
  - N-bit (notification) introduced in the EID-Record to ask for subscription
  - Map-Reply returned if subscription not supported or rejected
  - Map-Notify returned if subscription accepted
- Publication of mapping updates via Map-Notify
  - Ack'ed with Map-Notify-Ack

Subscription

# Initial state

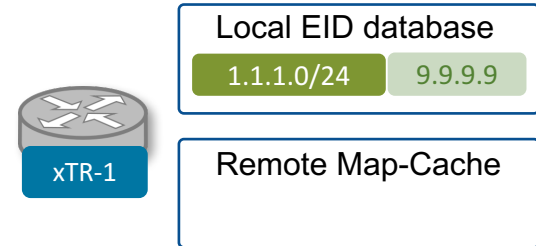
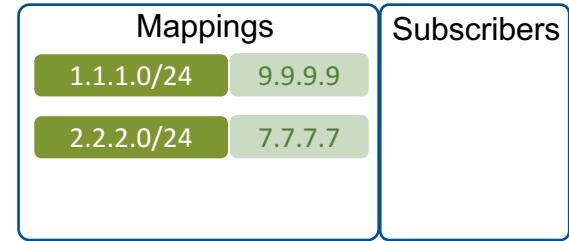

# Map Cache miss on xTR-1

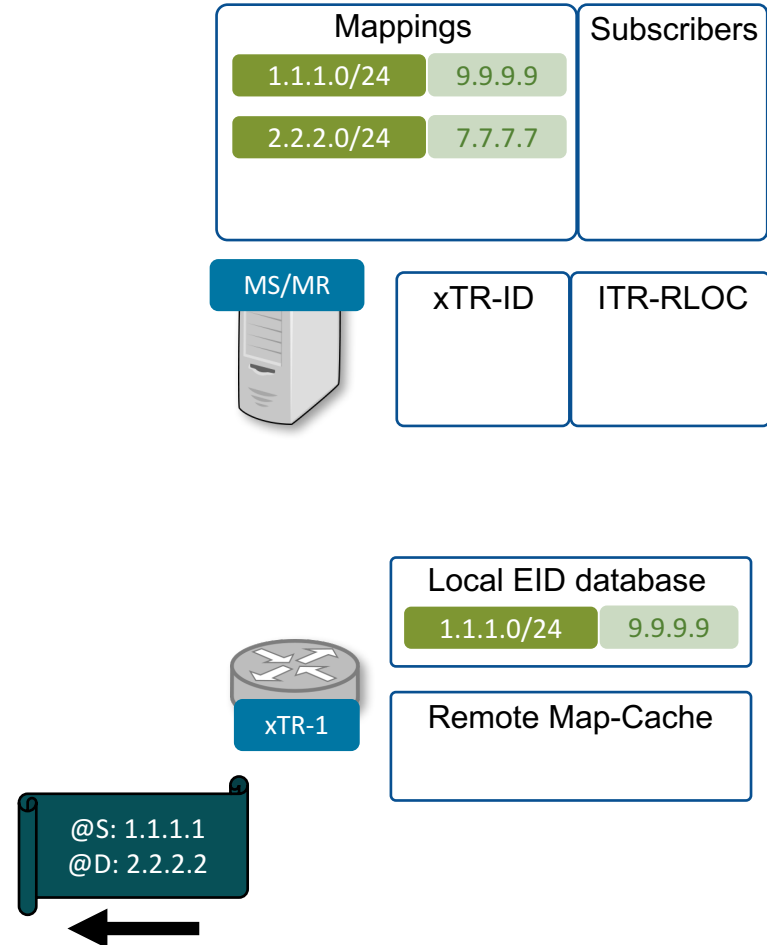

# Map-Request (with N-bit)

## Map-Request

- EID prefix = 2.2.2.2/32
- ITR-RLOC = 9.9.9.9
- Nonce = 12345678
- xTR-ID = xTR-1
- **N-bit = 1**

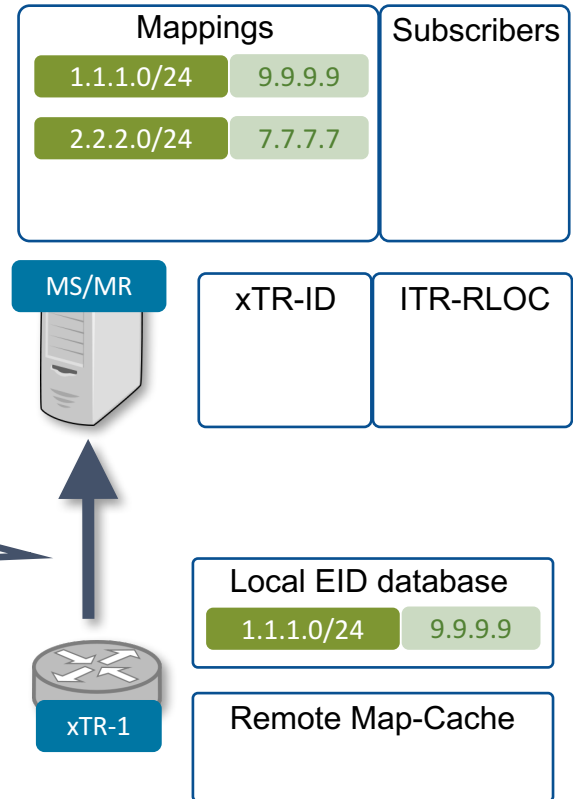

RFC 6830

draft-ietf-lisp-rfc6833bis

draft-rodrigueznatal-lisp-pubsub

# Subscriber added

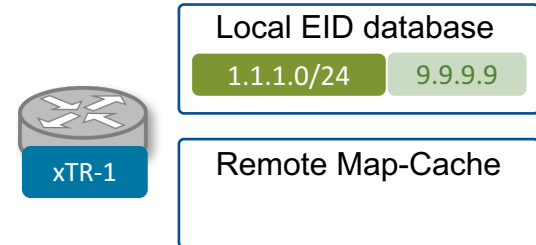
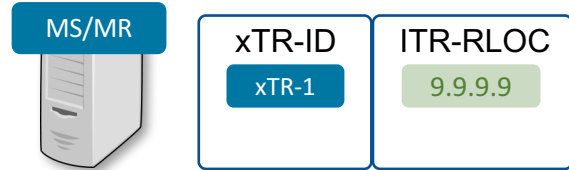
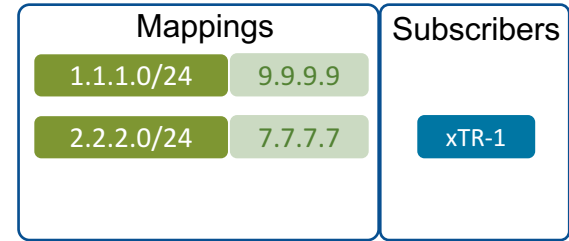

# Map-Notify

**Map-Notify**

- EID prefix = 2.2.2.0/24
- RLOC = 7.7.7.7
- Nonce = 12345678

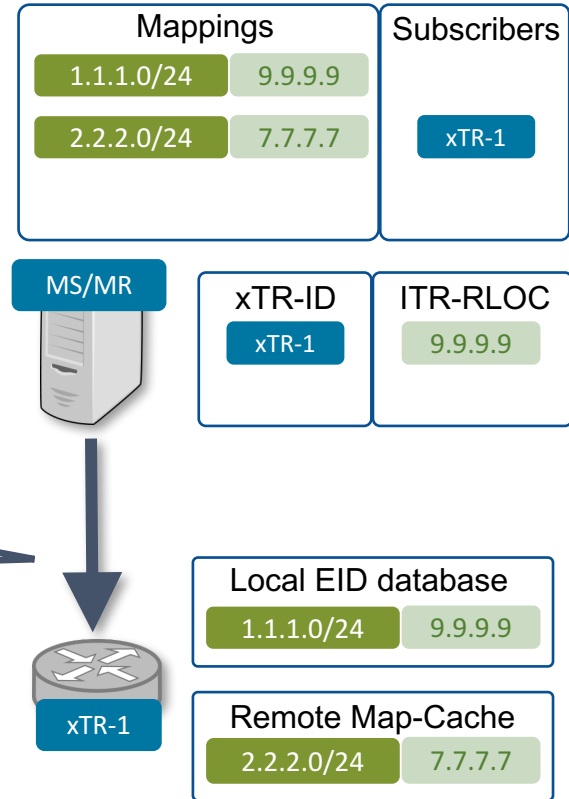



# Forward encap. packet

Mappings		Subscribers
1.1.1.0/24	9.9.9.9	xTR-1
2.2.2.0/24	7.7.7.7	



xTR-ID	ITR-RLOC
xTR-1	9.9.9.9

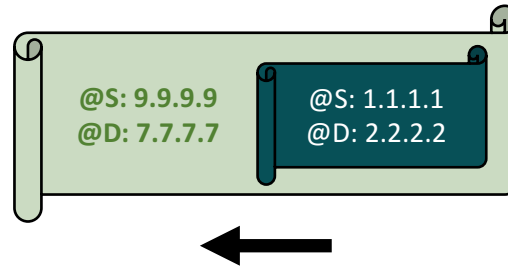

Local EID database	
1.1.1.0/24	9.9.9.9

Remote Map-Cache	
2.2.2.0/24	7.7.7.7

Publication

# Initial state

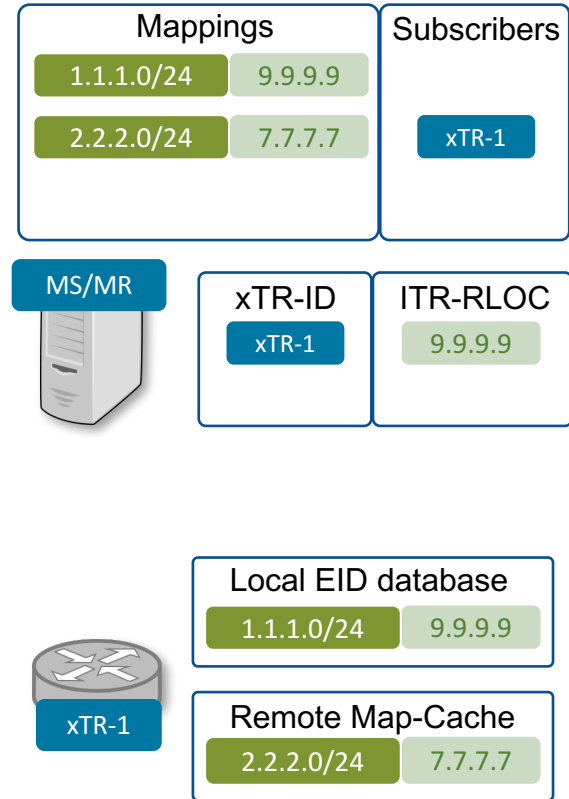

# Mapping changes

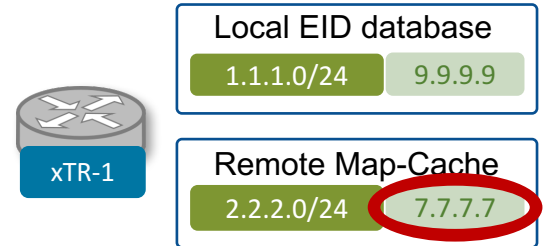
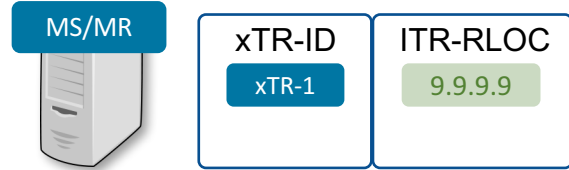
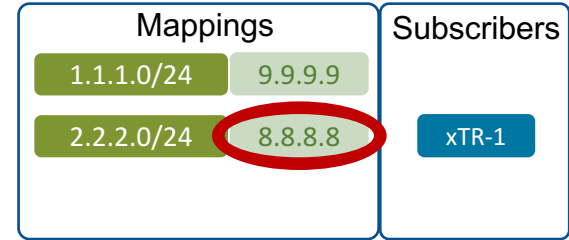

# Map-Notify to subscribers

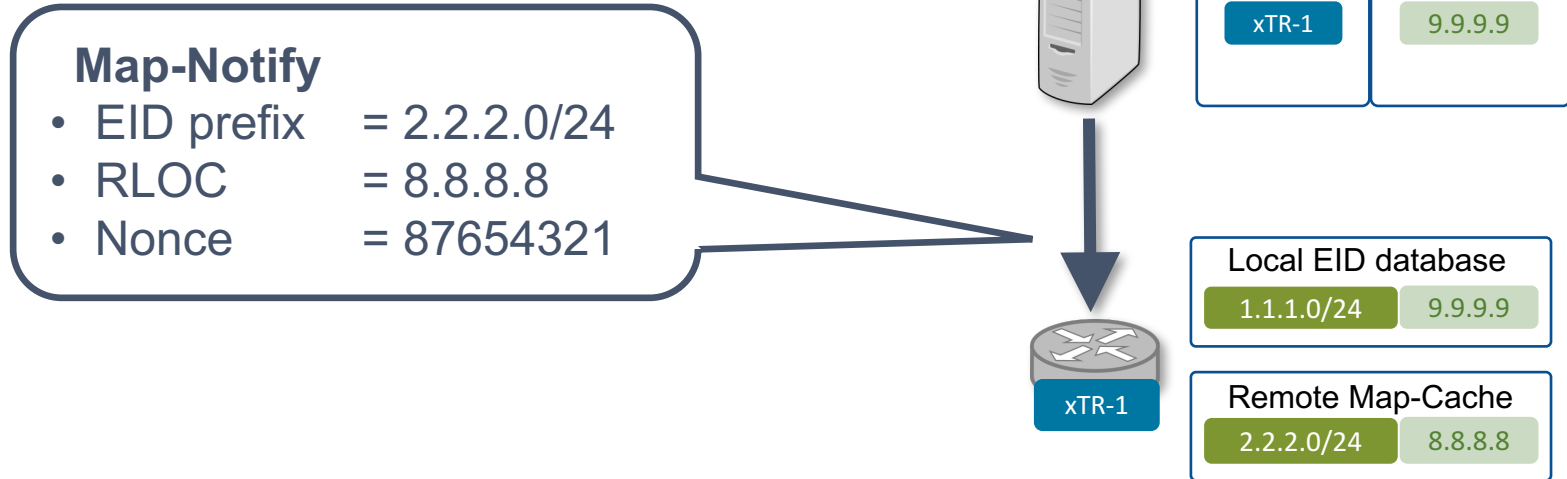

# Map-Notify-Ack to MS/MR

**Map-Notify-Ack**

- EID prefix = 2.2.2.0/24
- RLOC = 8.8.8.8
- Nonce = 87654321

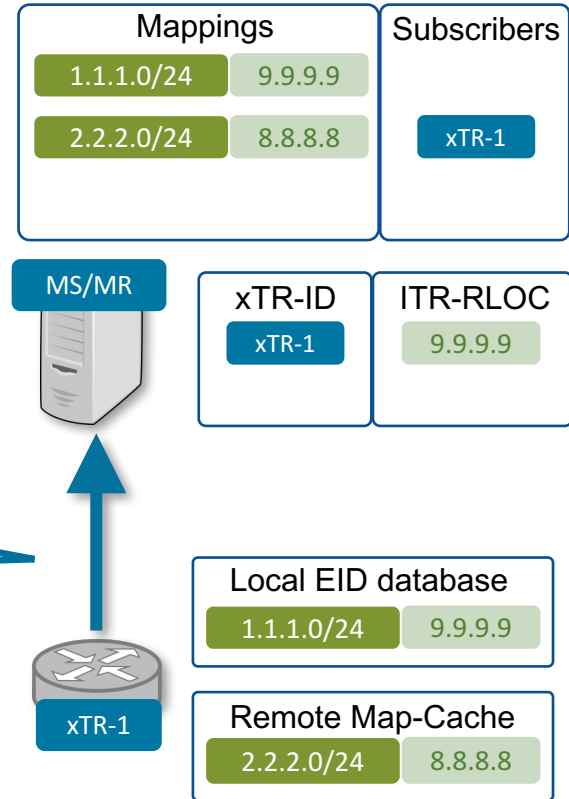

# Notes

- When subscriber wants to unsubscribe
  - It sends Map-Request with N-bit set and no ITR-RLOC (i.e. AFI = 0)
- When a prefix is unregistered in the Map-Server
  - Subscribers get a Map-Notify with TTL = 0
    - Which will be ack'ed with a Map-Notify-Ack as described

# LISP PubSub Demo

***IETF LISP WG Singapore***

November 2017

*Dino Farinacci & Fabio Maino*



# Demo Details

- **lig** client sends subscription Map-Requests
- Map-Server creates subscription state
- xTR changes RLOC-set
- Map-Server Map-Notifies **lig** client

# *lig* sends Map-Request

```
dino-macbook-> lig [1539]3.3.3.3  
Possible NAT in path, sending Info-Request ...  
Info-Reply received, public address 173.11.119.245, translated port 53121  
  
Send lig map-request to 146.148.38.82 for EID [1539]3.3.3.3 ...  
Received map-reply from 146.148.38.82 with rtt 0.064 secs:  
EID-prefix: [1539]3.3.3.0/24, ttl: 15 mins, rloc-set:  
  RLOC: 35.203.154.151, up/uw/mp/mw: 254/0/255/0, flags: lpR, RTR
```

```
dino-macbook-> lig-pubsub [1539]3.3.3.3  
Possible NAT in path, sending Info-Request ...  
Info-Reply received, public address 173.11.119.245, translated port 42098  
  
Send lig subscribe map-request to 146.148.38.82 for EID [1539]3.3.3.3 ...  
Received map-notify from 146.148.38.82 with rtt 0.063 secs:  
EID-prefix: [1539]3.3.3.0/24, ttl: 15 mins, rloc-set:  
  RLOC: 35.203.154.151, up/uw/mp/mw: 254/0/255/0, flags: lpR, RTR  
  
Waiting for map-notify EID [1539]3.3.3.3 RLOC-set changes ...
```

# Map-Server holds pubsub state

## LISP-MS Subscriber Information:

EID-prefix	Uptime TTL	Subscriber RLOC	xTR-ID	Nonce	Map-Notifies Sent
[1539]3.3.3.0/24	0:05:12 15 mins	10.240.102.121:4342	0x5610edee72a51cf425e6b73208d663b2	0xdfdf0e1d10c1d9c3	0

## xTR changes RLOC-set

```
lisp database-mapping {  
  prefix {  
    instance-id = 1539  
    eid-prefix = 3.3.3.0/24  
  }  
  rloc {  
    interface = eth0  
    rloc-record-name = g-xtr3  
  }  
}
```

adds RLOC →

```
lisp database-mapping {  
  prefix {  
    instance-id = 1539  
    eid-prefix = 3.3.3.0/24  
  }  
  rloc {  
    interface = eth0  
    rloc-record-name = g-xtr3  
  }  
  rloc {  
    rloc-record-name = joel-and-luigi  
  }  
}
```

# Map-Server sends Map-Notify

```

Map-Register -> flags: psItrnmf, record-count: 3, nonce: 0xaabbccdddfdf01, key/alg-id: 0/2, auth-len: 32, xtr-id: 0x8c91842d7f255da2, site-id: 0
EID-record -> record-ttl: 3 mins, rloc-count: 3, action: no-action, auth, map-version: 0, afi: 17, [iid]eid/ml: [1539]'g-xtr3.lispers.net'
Found [1539]'g-xtr3.lispers.net' for site 'lispers.net' for registering prefix [1539]'g-xtr3.lispers.net'
Authentication passed for dynamic EID-prefix [1539]'g-xtr3.lispers.net', key-id 0
RLOC-record -> flags: lpR, 0/0/255/0, afi: 0, rloc: no-address, rloc-name: joel-and-luigi
RLOC-record -> flags: lpR, 0/0/255/0, afi: 1, rloc: 104.198.91.207, rloc-name: xtr3
RLOC-record -> flags: lpR, 254/0/255/0, afi: 1, rloc: 35.203.154.151

```

```

EID-record -> record-ttl: 3 mins, rloc-count: 3, action: no-action, auth, map-version: 0, afi: 1, [iid]eid/ml: [1539]3.3.3.0/24
Found [1539]3.3.3.0/24 for site 'lispers.net' for registering prefix [1539]3.3.3.0/24
Authentication passed for dynamic EID-prefix [1539]3.3.3.0/24, key-id 0
RLOC-record -> flags: lpR, 0/0/255/0, afi: 0, rloc: no-address, rloc-name: joel-and-luigi
RLOC-record -> flags: lpR, 0/0/255/0, afi: 1, rloc: 104.198.91.207, rloc-name: xtr3
RLOC-record -> flags: lpR, 254/0/255/0, afi: 1, rloc: 35.203.154.151

```

```

Notify subscriber 10.240.102.121:4342 xtr-id 0x1207566787cde8933b1fcdabaed65641 for [1539]3.3.3.0/24, nonce 0xdfdf0e1d10cle7df
Send Map-Notify for RLOC-set change

```

```

Map-Notify -> record-count: 1, nonce: 0xdfdf0e1d10cle7df, key/alg-id: 00, auth-len: 0, auth-data:
EID-record -> record-ttl: 3 mins, rloc-count: 3, action: no-action, auth, map-version: 0, afi: 1, [iid]eid/ml: [1539]3.3.3.0/24
Send Map-Notify to xTR [0]10.240.102.121
Send IPC 252 bytes to 10.240.102.121 4342, control-packet: 40000001 dfe7c110 1d0edfdf 00000000 00000003 03181000 00004003 00000200 000a0000 06030001
00000100 00130000 00116a6f 656c2d61 6e642d6c 75696769 000000ff 00000140 03000001 00000d00 0168c65b cf001178 74723300 fe00ff00 00010001 23cb9a97
00000200 00160000 06030002 20010005 00030000 00000000 00000003 0000ff00 00014003 00000100 00130000 00116a6f 656c2d61 6e642d6c 75696769 000000ff
0168c65b cf001178 74723300 fe00ff00 00010001 23cb9a97 00000000 00000000 8c91842d 7f255da2 00000000 00000000
Send IPC 287-out-of-287 byte to lisp-core-pkt succeeded

```

```

EID-record -> record-ttl: 3 mins, rloc-count: 3, action: no-action, auth, map-version: 0, afi: 2, [iid]eid/ml: [1539]2001:5:3::3/128
Found [1539]2001:5:3::3/128 for site 'lispers.net' for registering prefix [1539]2001:5:3::3/128
Authentication passed for dynamic EID-prefix [1539]2001:5:3::3/128, key-id 0
RLOC-record -> flags: lpR, 0/0/255/0, afi: 0, rloc: no-address, rloc-name: joel-and-luigi
RLOC-record -> flags: lpR, 0/0/255/0, afi: 1, rloc: 104.198.91.207, rloc-name: xtr3
RLOC-record -> flags: lpR, 254/0/255/0, afi: 1, rloc: 35.203.154.151
Changed RLOC-set, Map-Notifying old RLOC-set

```

```

Bit-stuffing, round 7 segments
Receive 252 bytes from 173.11.119.245 41190, packet: 50000001 dfe7c110 1d0edfdf 00000000 00000003 03181000 00004003 00000200 000a0000 06030001 03030300
00130000 00116a6f 656c2d61 6e642d6c 75696769 000000ff 00000140 03000001 00000d00 0168c65b cf001178 74723300 fe00ff00 00010001 23cb9a97 00000003
00160000 06030002 20010005 00030000 00000000 00000003 0000ff00 00014003 00000100 00130000 00116a6f 656c2d61 6e642d6c 75696769 000000ff 00000140
cf001178 74723300 fe00ff00 00010001 23cb9a97 00000000 00000000 8c91842d 7f255da2 00000000 00000000
Map-Notify-Ack -> record-count: 1, nonce: 0xdfdf0e1d10cle7df, key/alg-id: 00, auth-len: 0, auth-data:
EID-record -> record-ttl: 3 mins, rloc-count: 3, action: no-action, auth, map-version: 0, afi: 1, [iid]eid/ml: [1539]3.3.3.0/24
Dequeue Map-Notify from retransmit queue, key is: dfdf0e1d10cle7df

```

## LISP-MS Subscriber Information:

EID-prefix	Uptime TTL	Subscriber RLOC	xTR-ID	Nonce	Map-Notifies Sent
[1539]3.3.3.0/24	0:02:27 15 mins	10.240.102.121:4342	0x1207566787cde8933b1fcdabaed65641	0xdfdf0e1d10cle7df	1

# *lig* gets Map-Notify

```
Waiting for map-notify EID [1539]3.3.3.3 RLOC-set changes ...
```

```
Received map-notify from map-server 146.148.38.82
```

```
EID-prefix: [1539]3.3.3.0/24, ttl: 3 mins, rloc-set:
```

```
RLOC: no-address, up/uw/mp/mw: 0/0/255/0, flags: lpR, rloc-name: joel-and-luigi
```

```
RLOC: 104.198.91.207, up/uw/mp/mw: 0/0/255/0, flags: lpR, rloc-name: xtr3
```

```
RLOC: 35.203.154.151, up/uw/mp/mw: 254/0/255/0, flags: lpR, RTR
```

```
Waiting for map-notify EID [1539]3.3.3.3 RLOC-set changes ...
```