



COIN-RG 109

IETF-LISP-NEXAGON

Virtual Routing for AI Edge Reduction



AI to the Edge

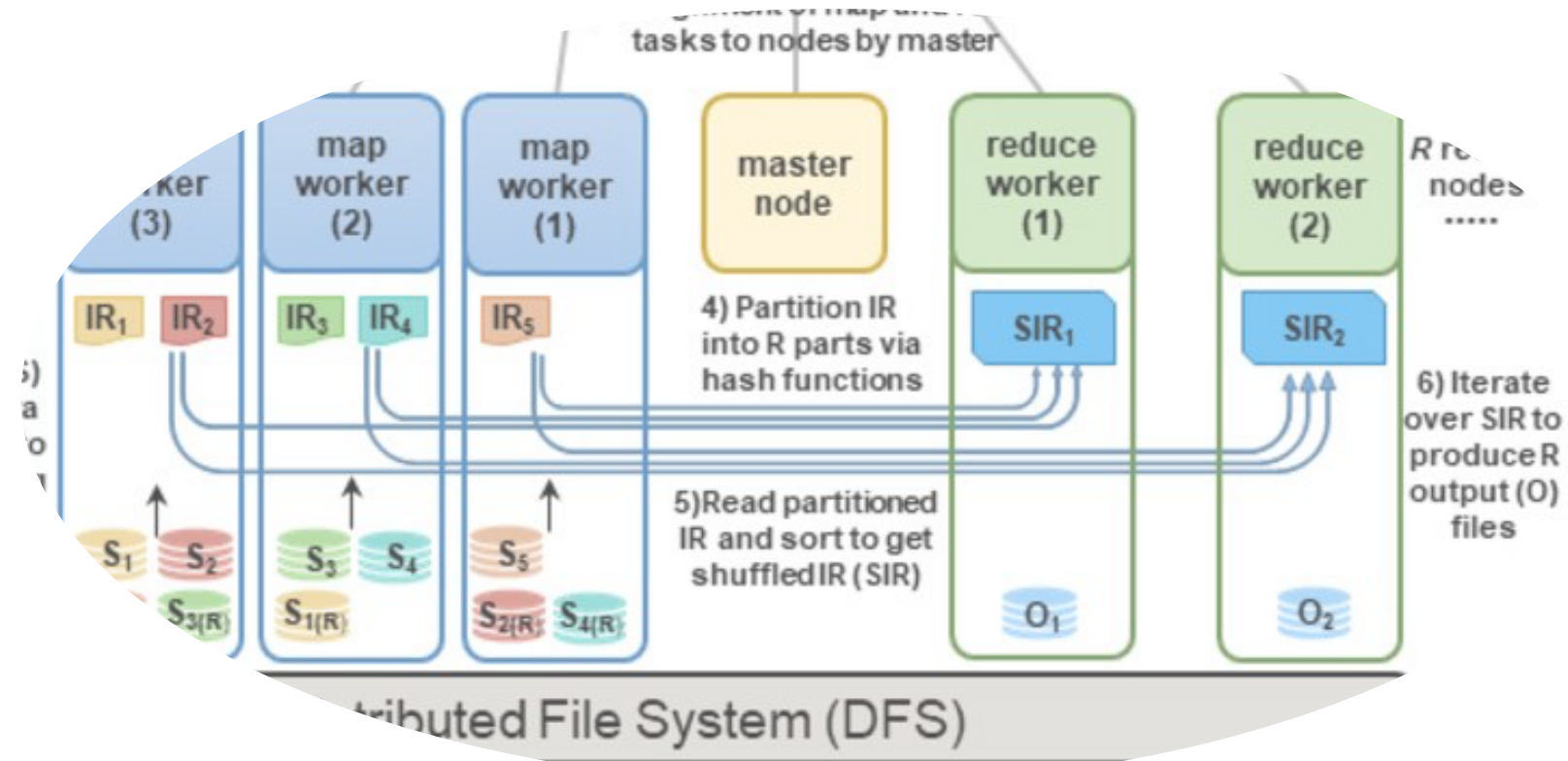

Cloud AI map-reduce:

- Raw data sampling => insights
- High EMR/Spark concurrency
- Spine-leaf Scatter-gather workloads

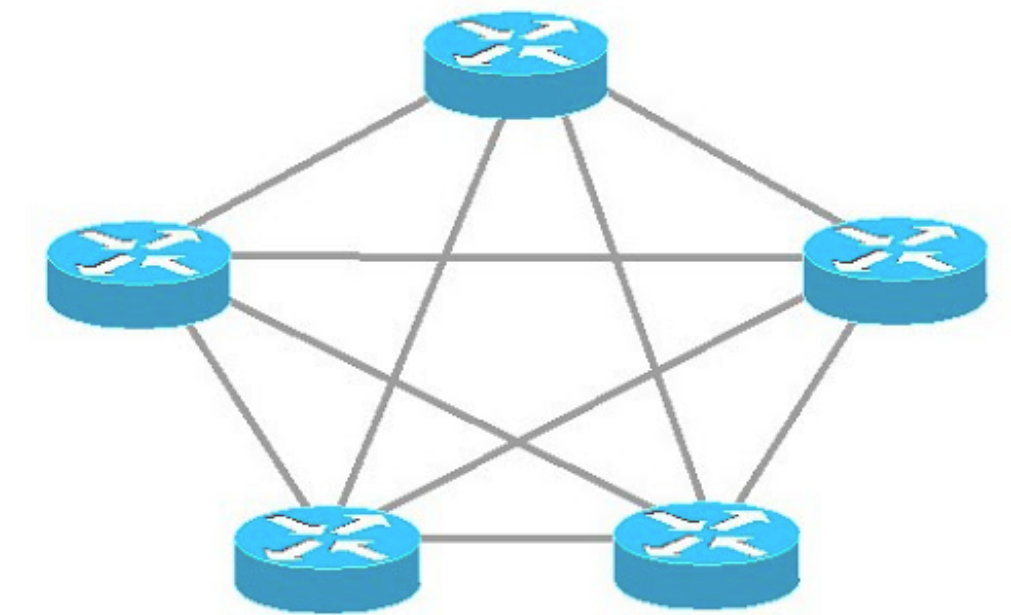
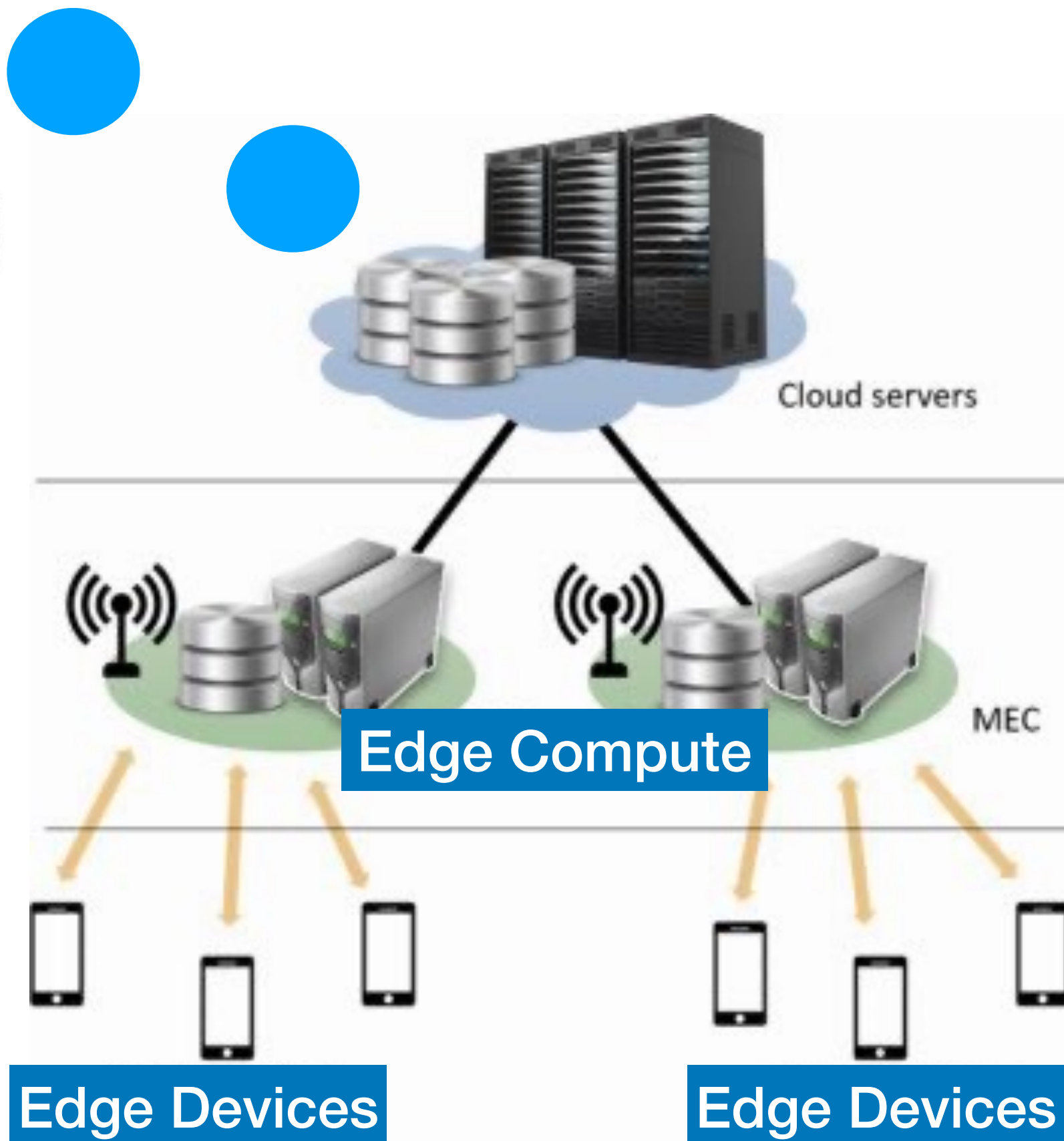

Edge Network Aggregation:

- Sub-sec SLA use-cases
- Scale heavy fresh upload
- Leverage GPU economics
- Regulatory and commercial

Edge Alternatives to Map IOT Samples Reduce to AI Insights

Auto Case Study

Resolution 15 ~1 (meter²) => HID Resolution 9 (7⁶ meter²) => EID

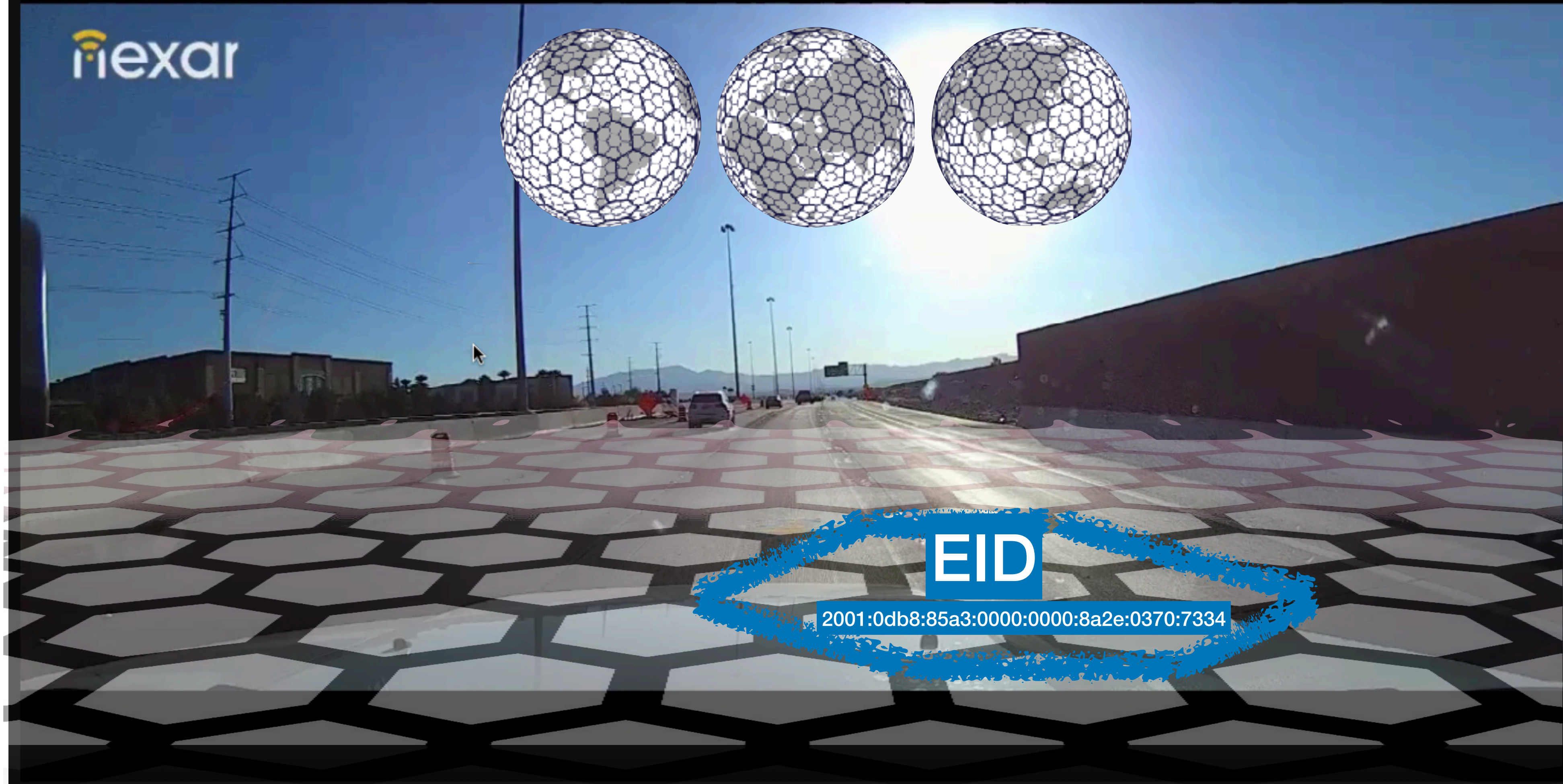

Cyber Case Study

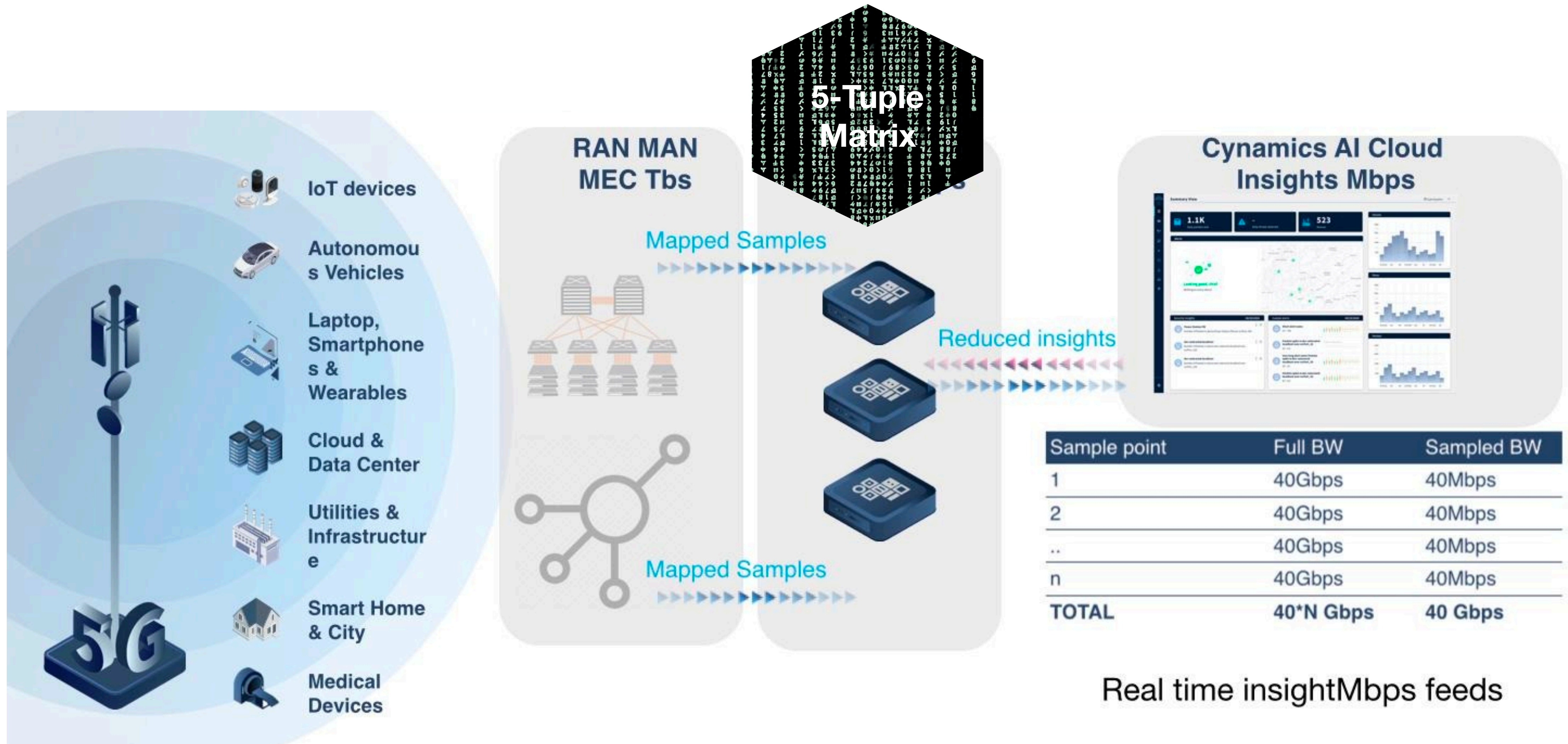

Virtual Routing 101: IP over UDP

Basic Overlay Standards Specify Encapsulations, NOT How to Route in the Overlays

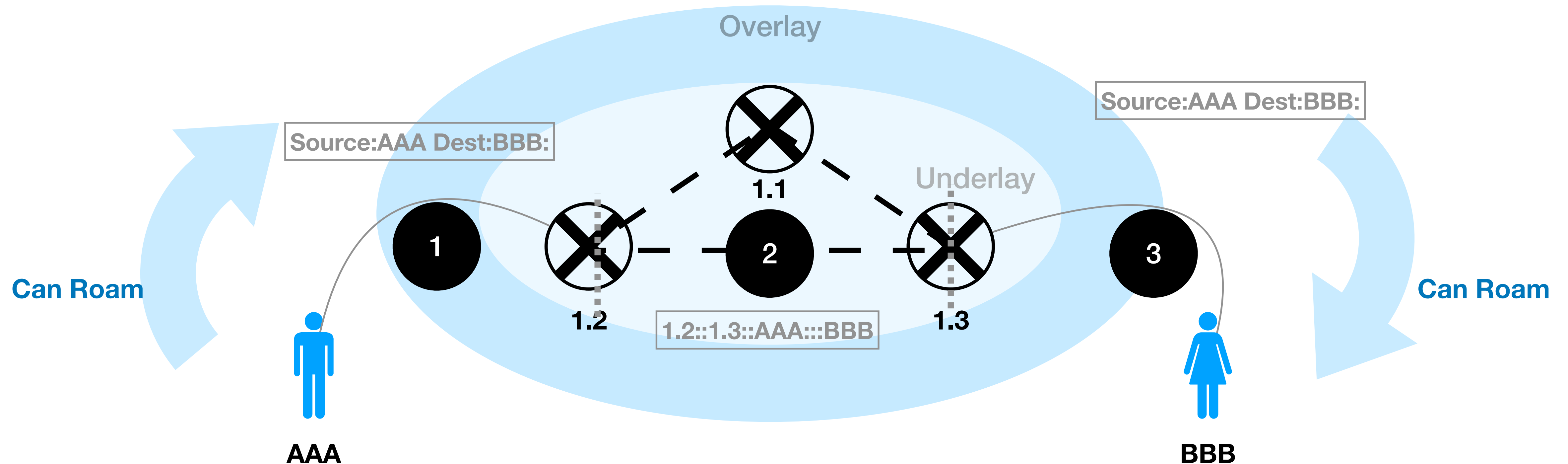

Use Tunnels to route two sets of addresses:
(1) Logical-Overlay (2) Topological-Underlay

LISP Overlay

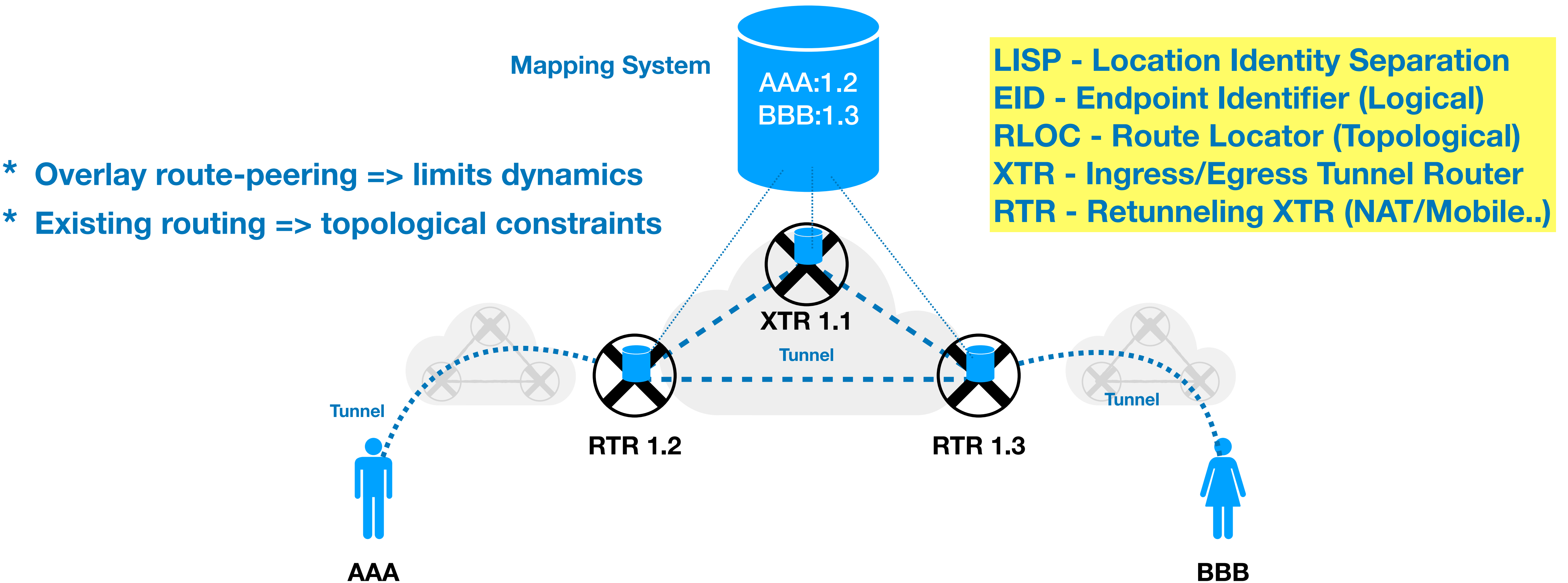

IP Underlay Scales Mapping System: logical EIDs => any RLOC EIDs functions as => Map-Reduce Context and Routed Data index

Signal-Free Multicast

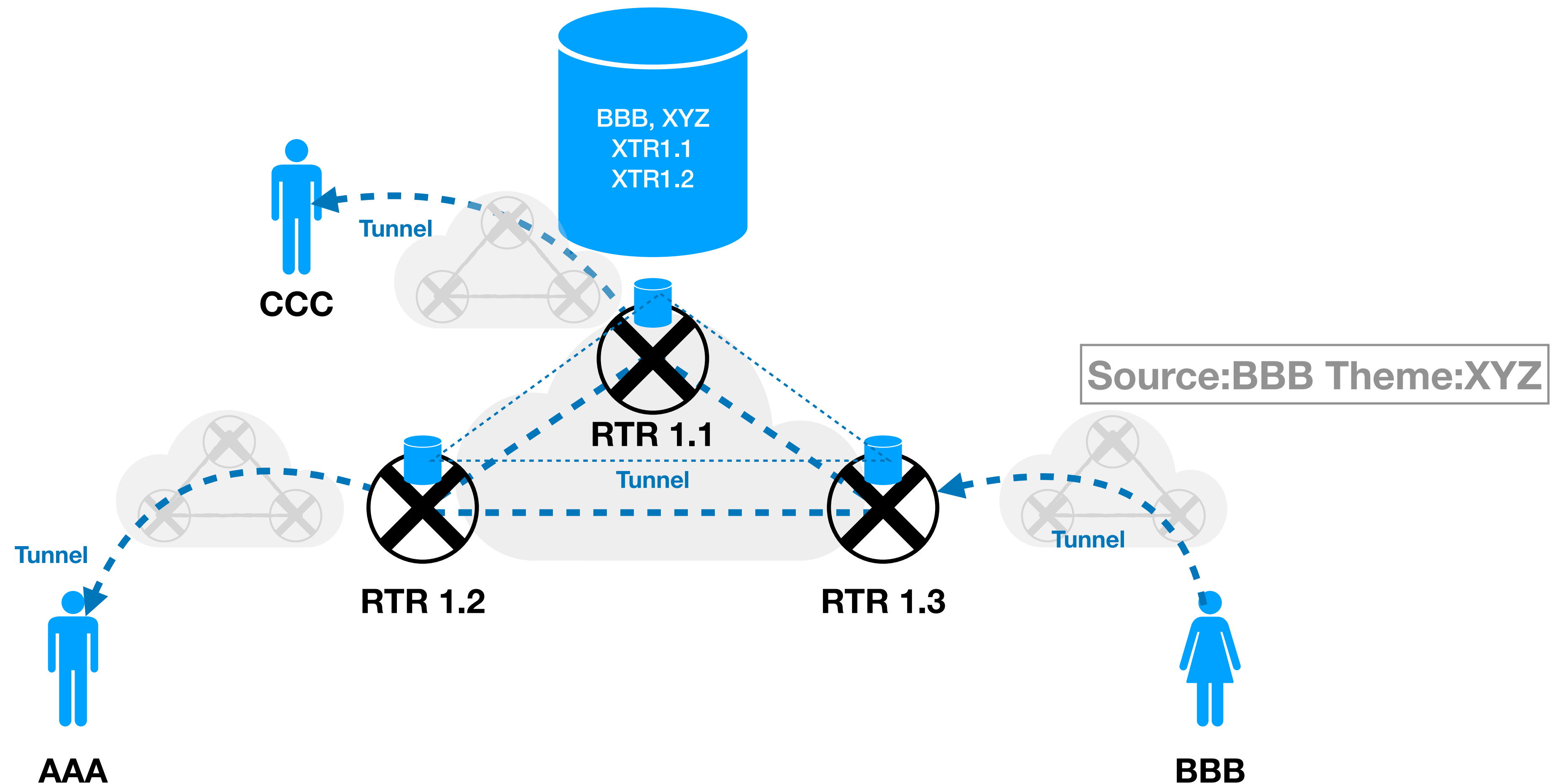

**We can use mapping systems for Signal Free multicast
Scales to millions map-reduced scoped feeds to thousands of clients each**

Communications Matrix EIDs

dotCom dotOrg dotGov dot.IO
 VPC1 VPC2 VPC3 VPC4

5 Tuple masks EIDs

Sflow/IPFIX Sampling

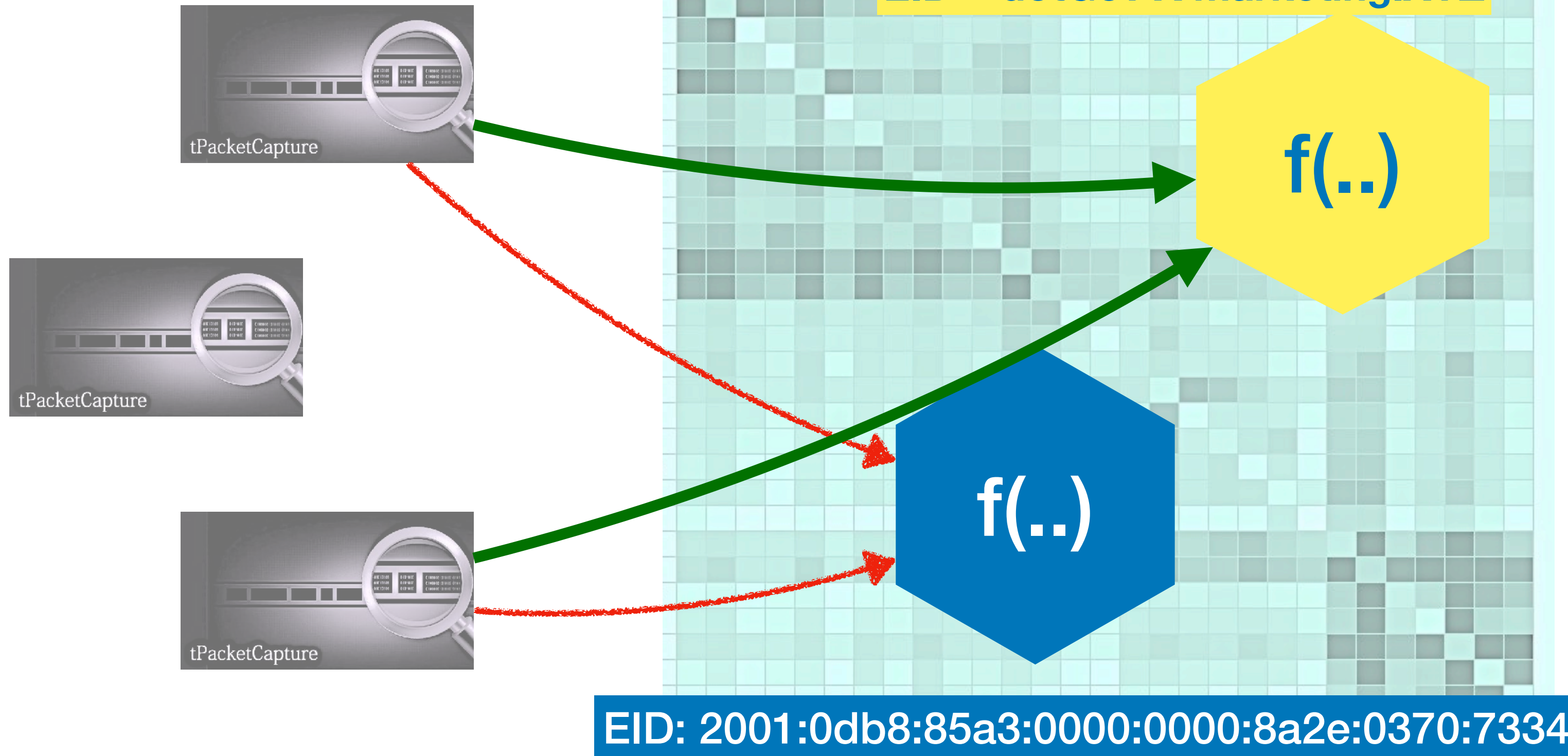

Attacks and Stats Feeds

marketing.XYZ.com
 Subnet 1
 .
 .
 Subnet X
 engineering.XYZ.com
 1
 .
 .
 Y
 manufacturing.XYZ.com
 1
 .
 .
 Z



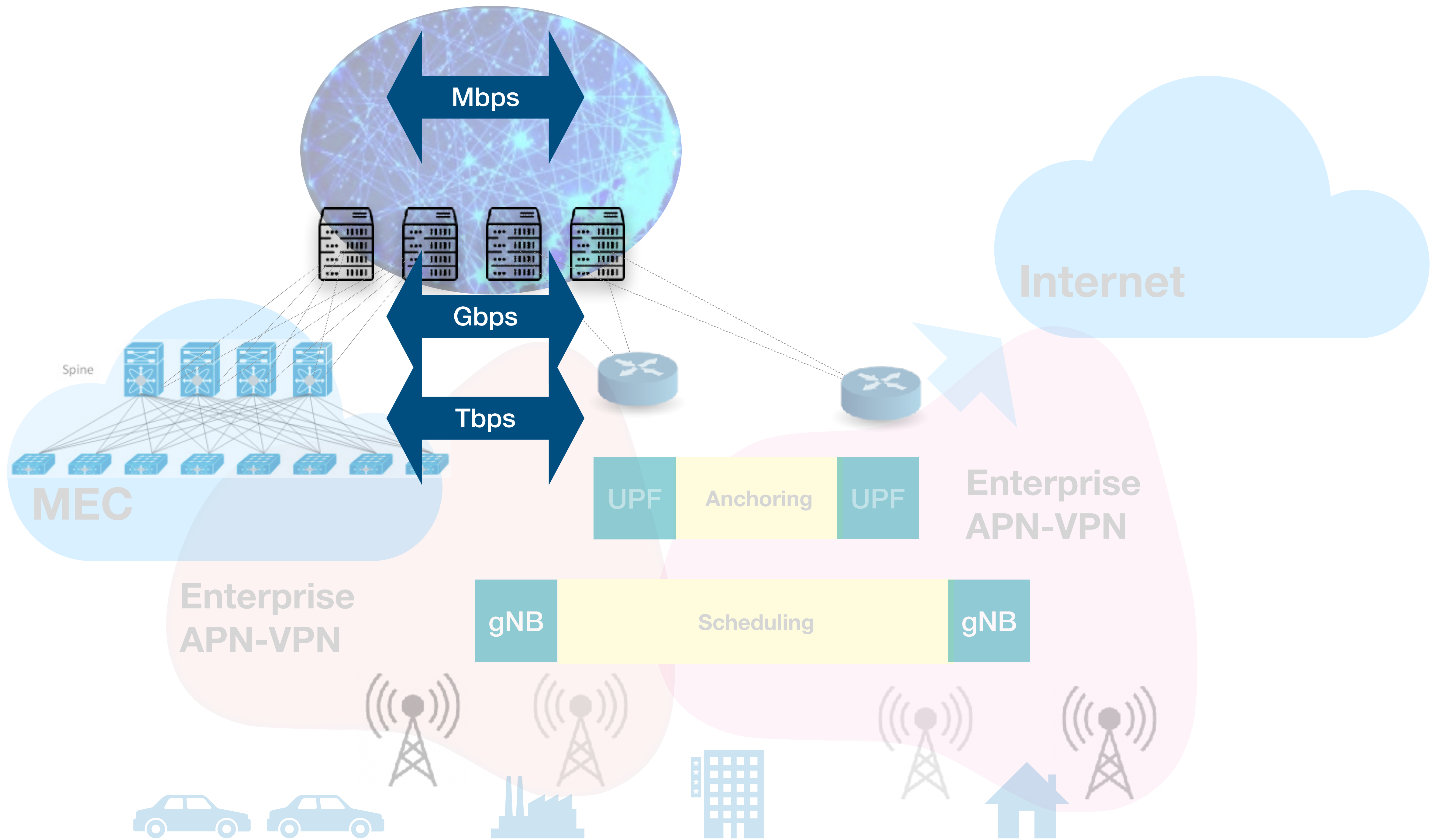

The Pattern

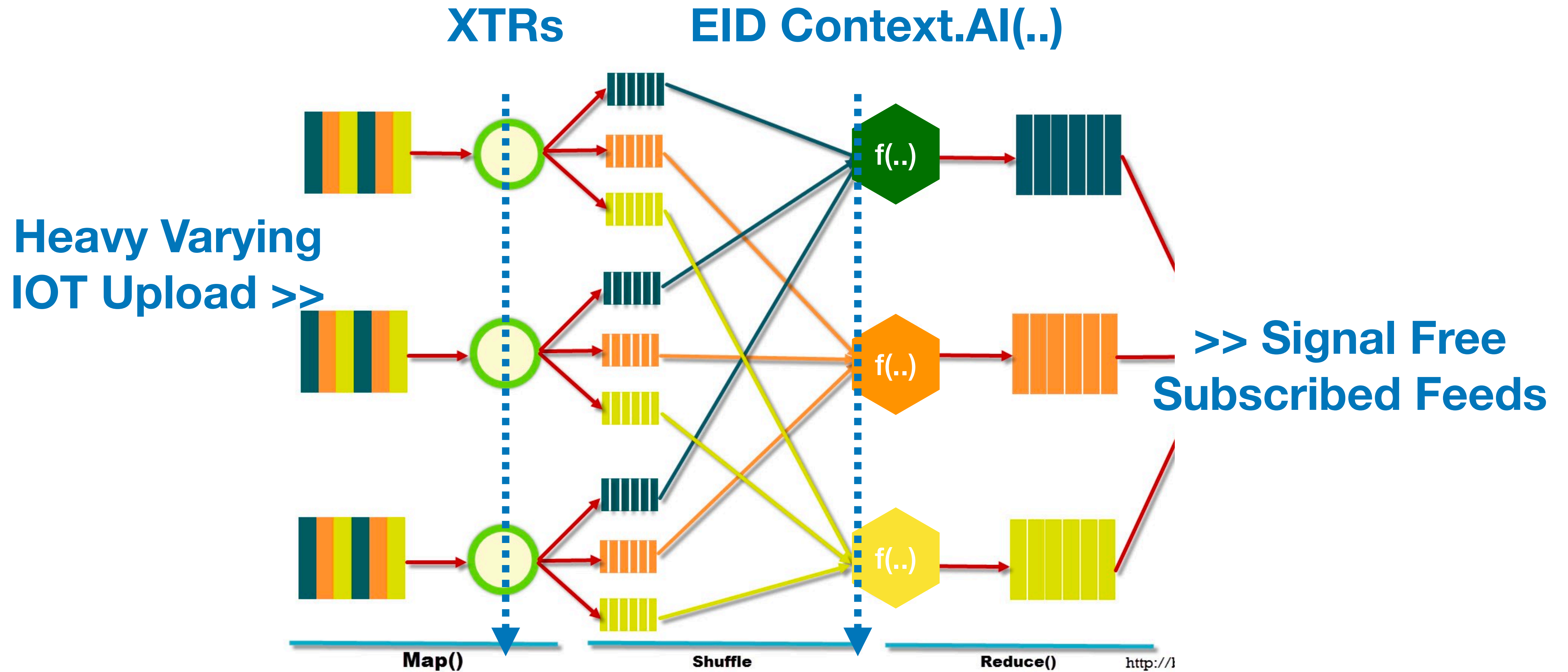

Automotive

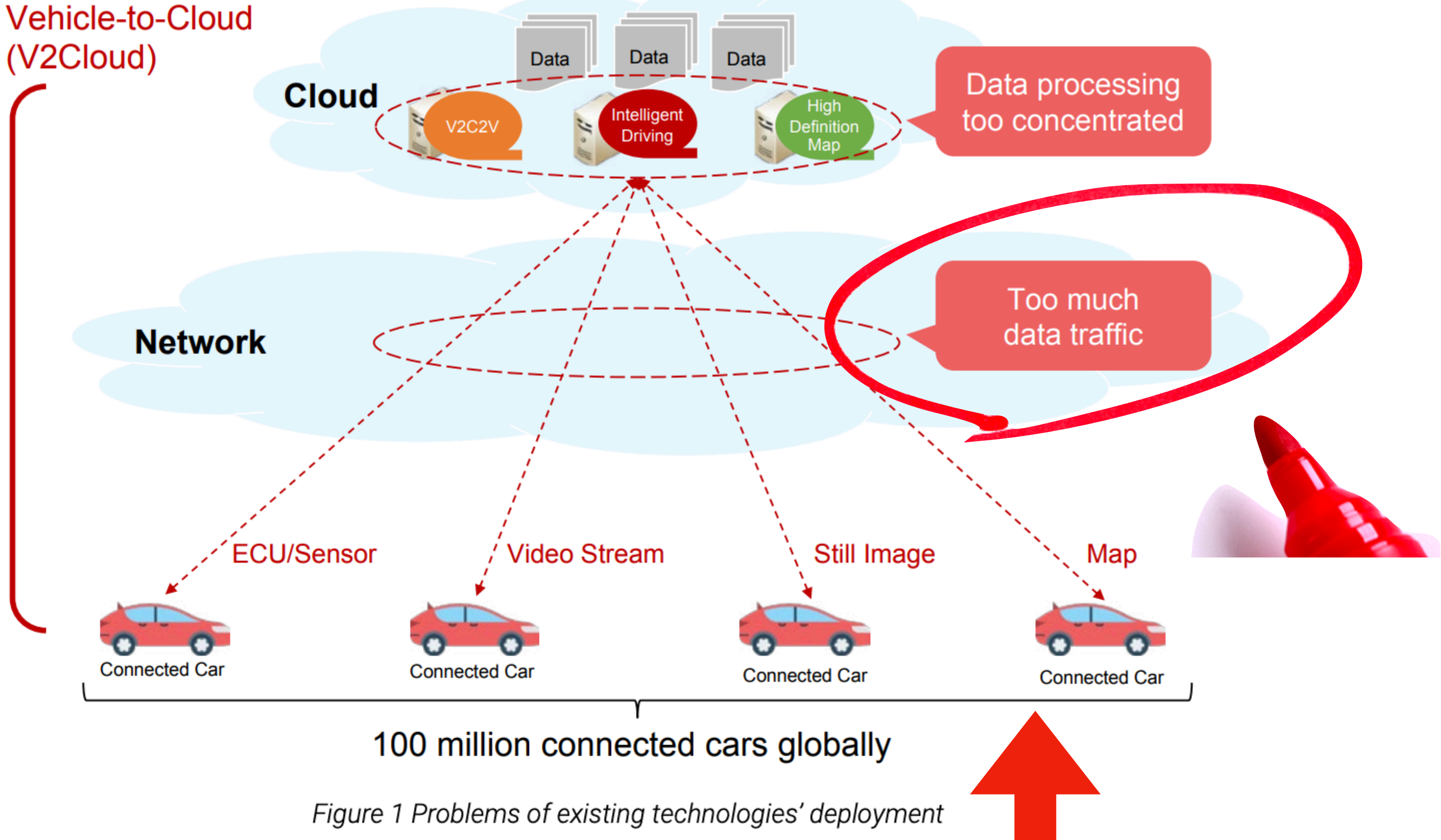
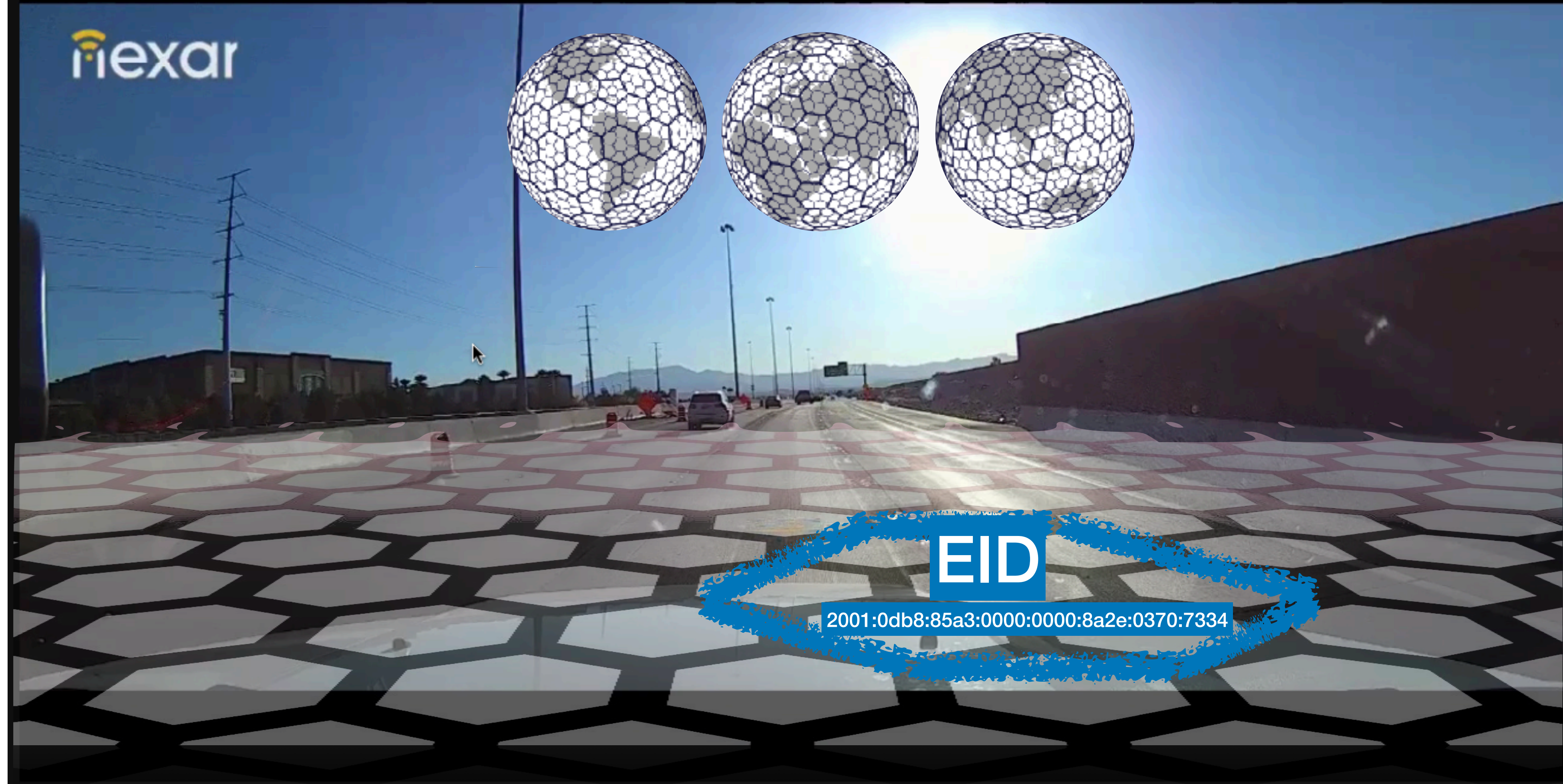

Figure 1 Problems of existing technologies' deployment

Heavy Fresh Vision & Sensory Continues Upload

Physical World EIDs

Resolution 15 ~1 (meter²) => HID Resolution 9 (7⁶ meter²) => EID



Map-Reduced to Feeds

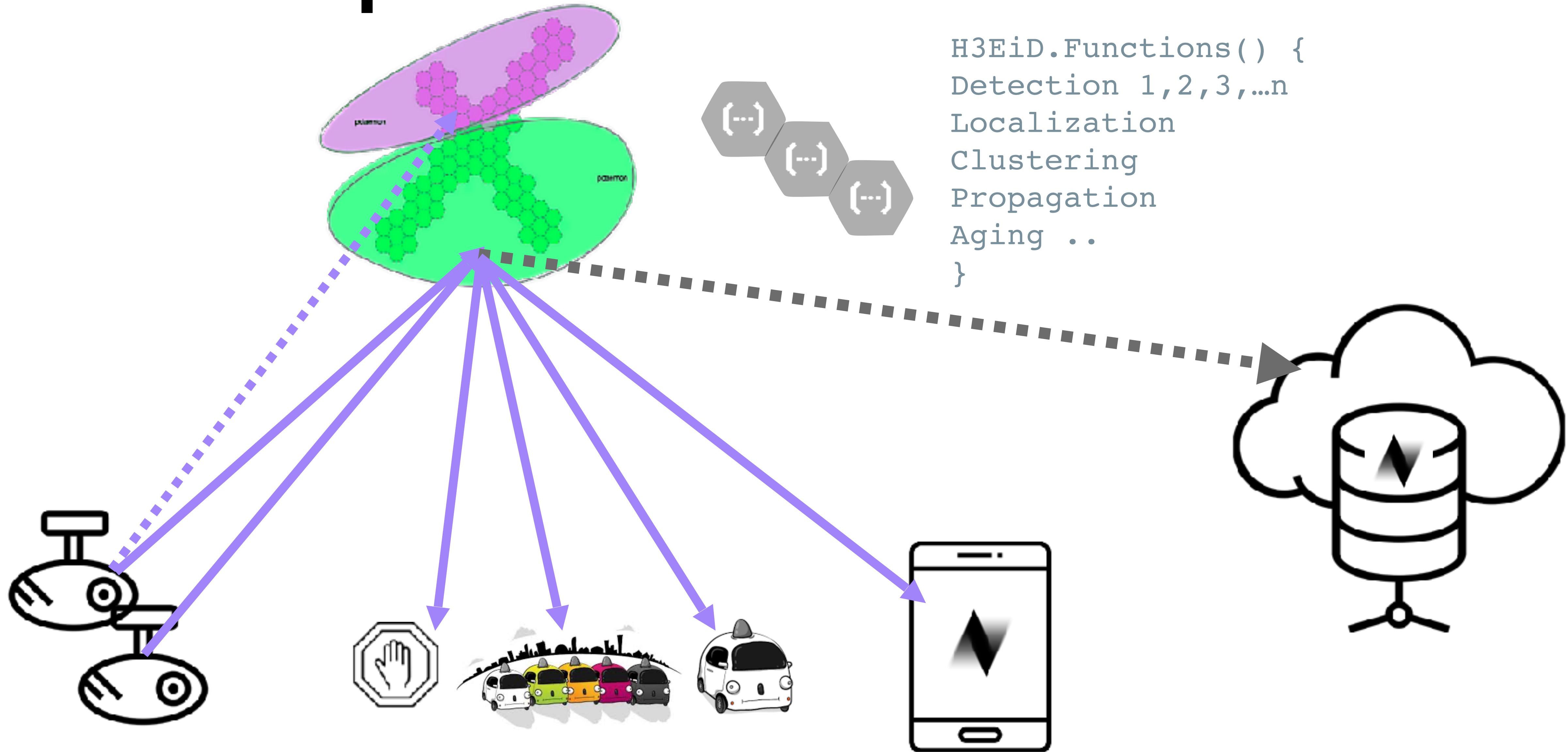

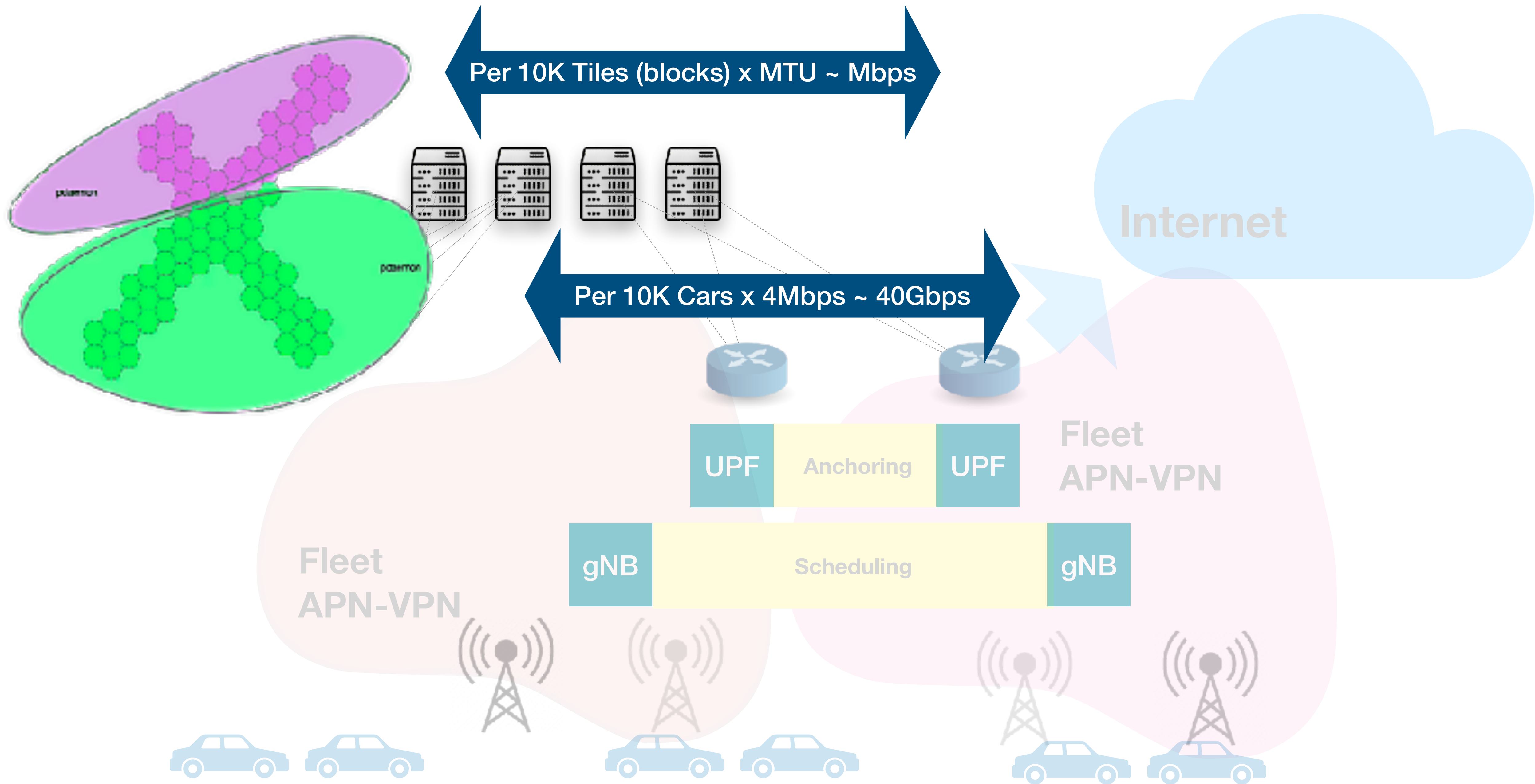

Functional Reduction: EID.Context::AI(..)

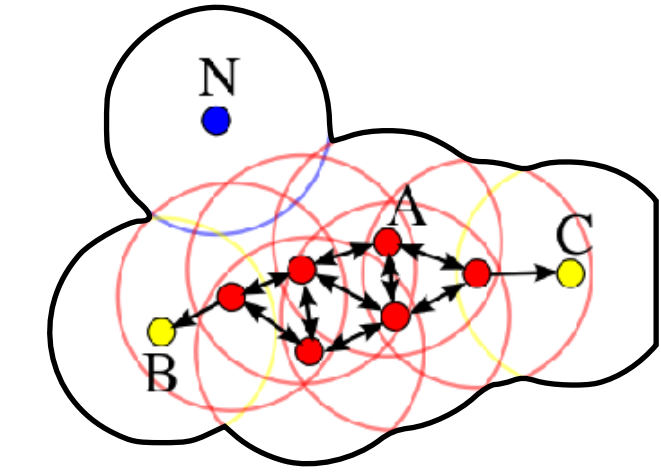

Context: DBScan, Simplex coalescing, Homography, Visual localization
Change detection, Lane number, Traffic direction, neighboring tiles ...

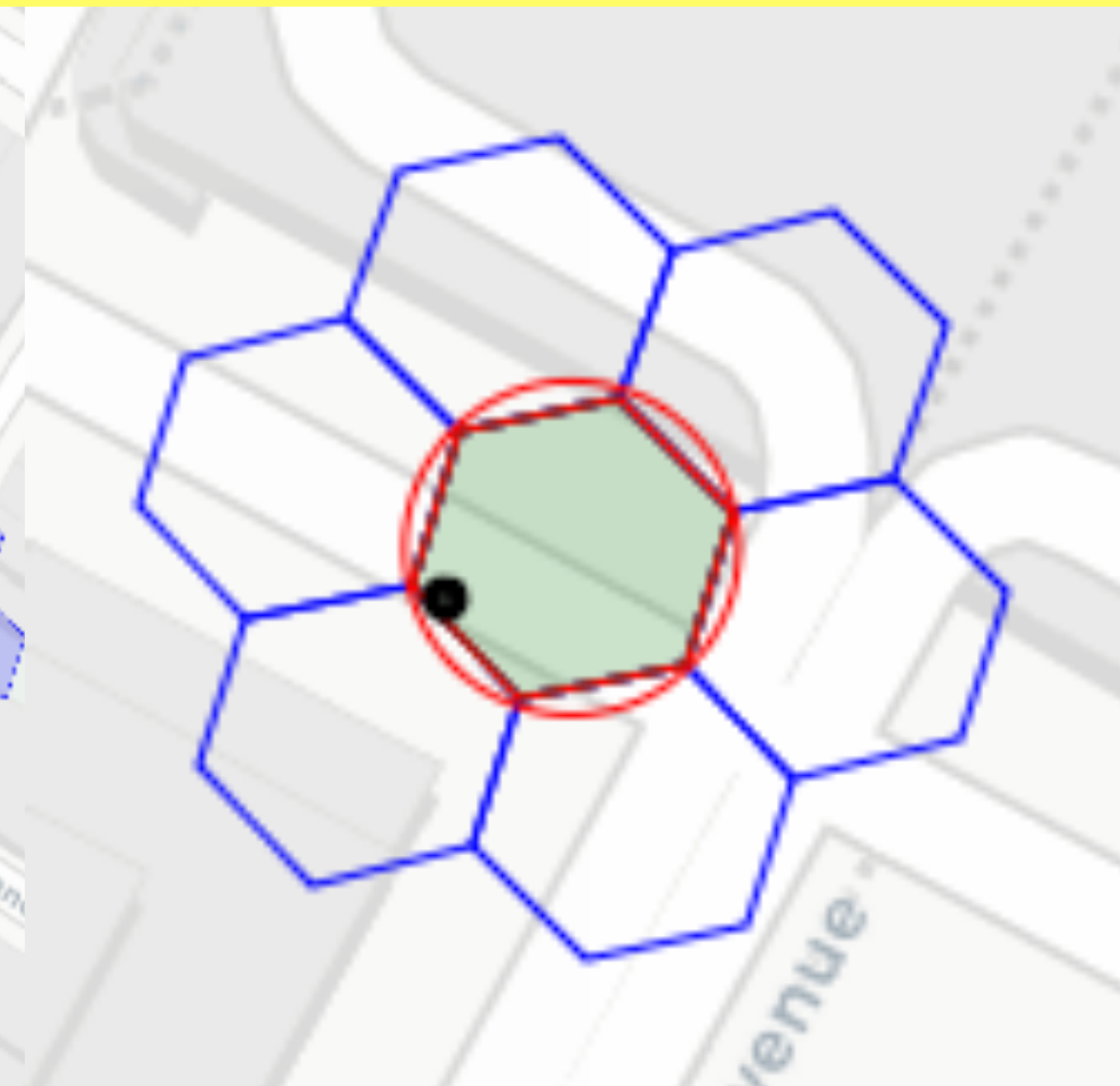
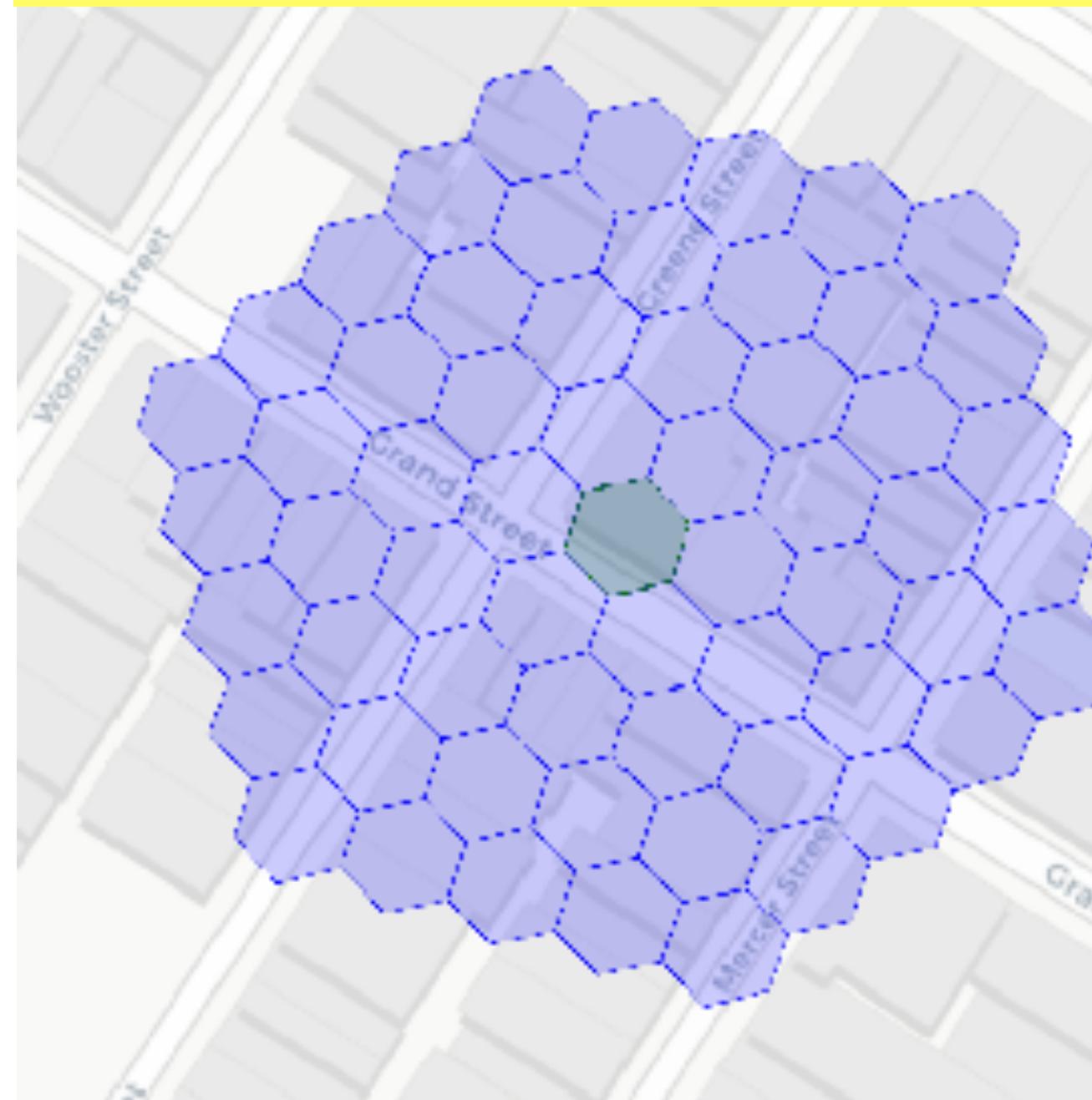

Interoperable Off-The-Shelf

```

-0-|-1-|-2-|-3-|-4-|-5-|-6-|-7-|-8-|-9-|-A-|-B-|-C-|-D-|-E-|-F-
      H3 Hexagon ID Key
-0-|-1-|-2-|-3-|-4-|-5-|-6-|-7-|-8-|-9-|-A-|-B-|-C-|-D-|-E-|-F-
      H3 Hexagon State-Value
  
```

Where/What Reduced Feed Per Context EID

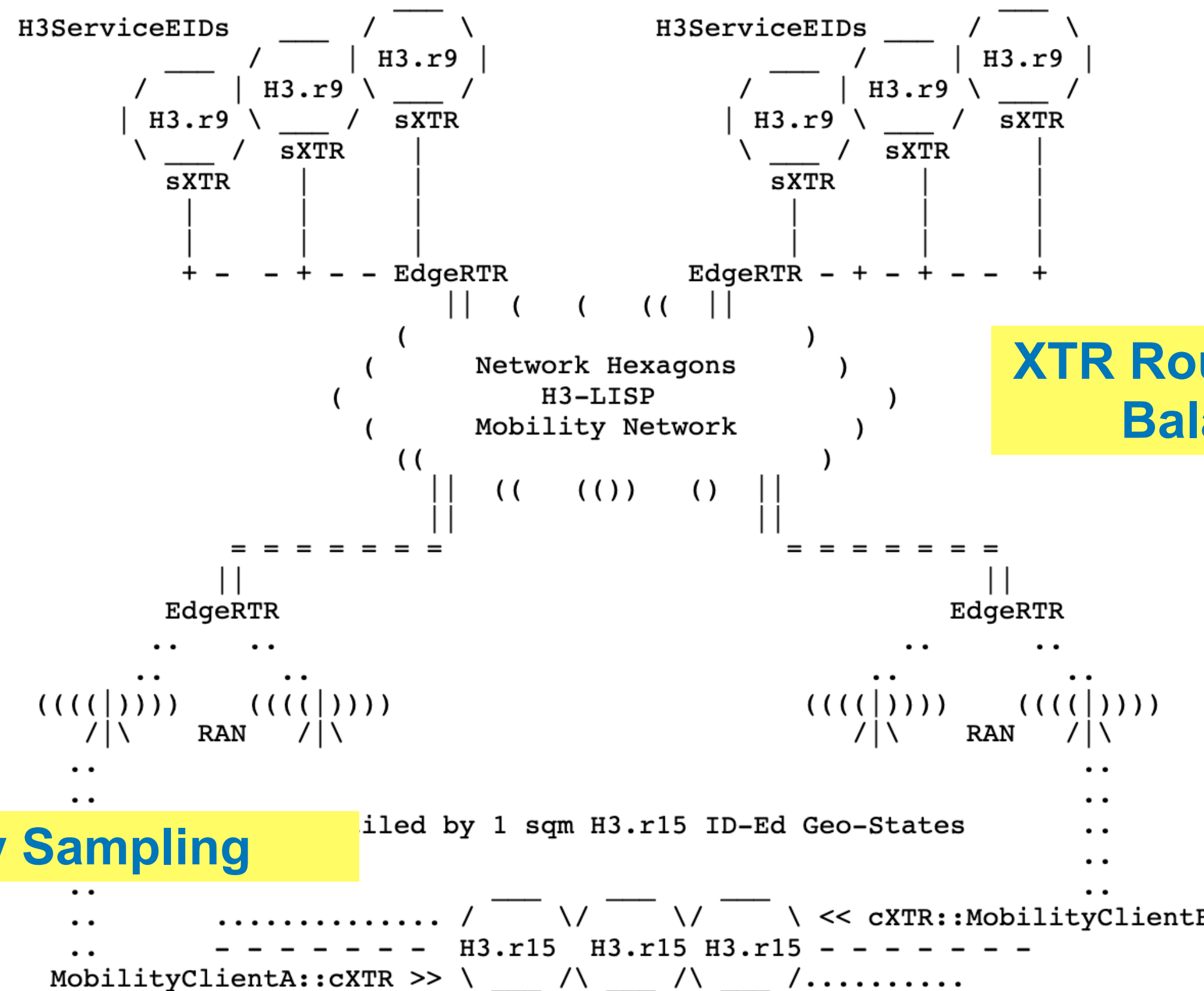

XTR Routing => Deployment Scaling
Balancing, H/A, Protections

Street Vision & Sensory Sampling

filed by 1 sqm H3.r15 ID-Ed Geo-States

Routed HPC Edge

- Engage high concurrency GPU machines
- Choose best upload aggregation points
- Choose best GPU economics for the task
- Comply with private premise constraints

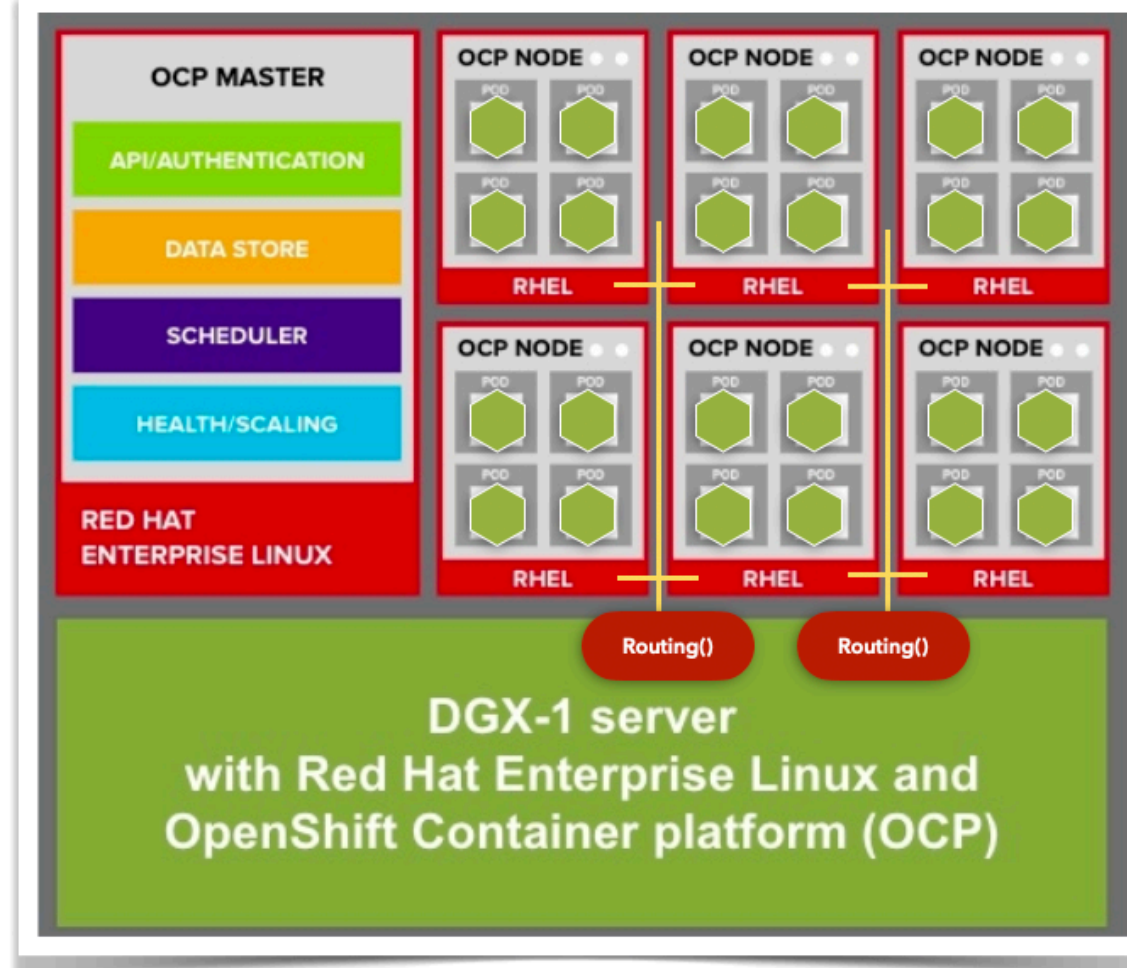

Portable AI Network Nodes

Each node aggregates IoT vision & sensory and generates geo-spatial feeds. Feeds consist of verified current state and latest filtered frames per geo-location. Feeds are available to mobile clients, driving & parking apps, command & control. Feed can be uploaded to cloud databases for history, trends, and deeper queries. Each node facilitates protected sandboxed hosted **feed-taps** for enterprise specific data derivatives.

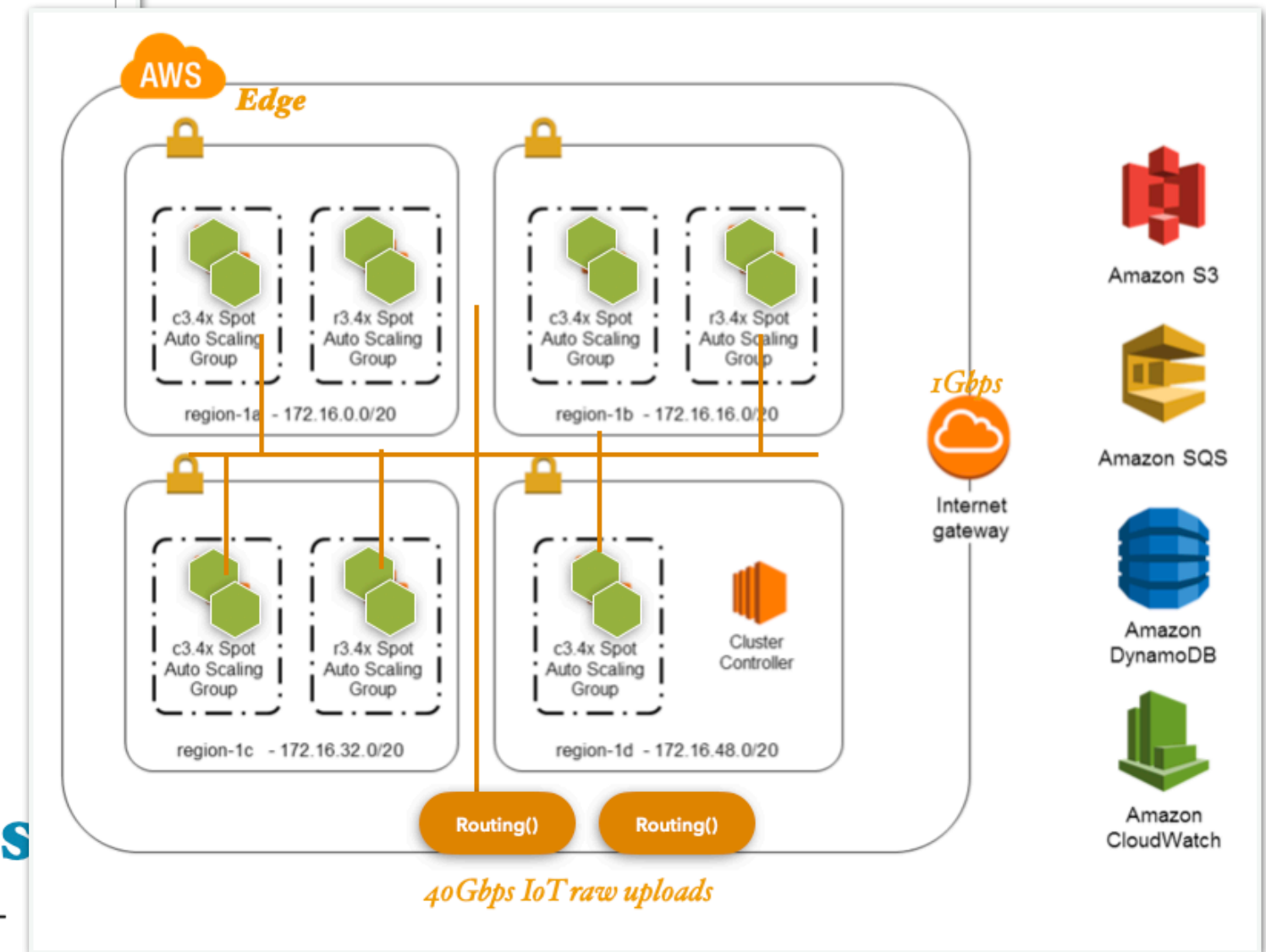
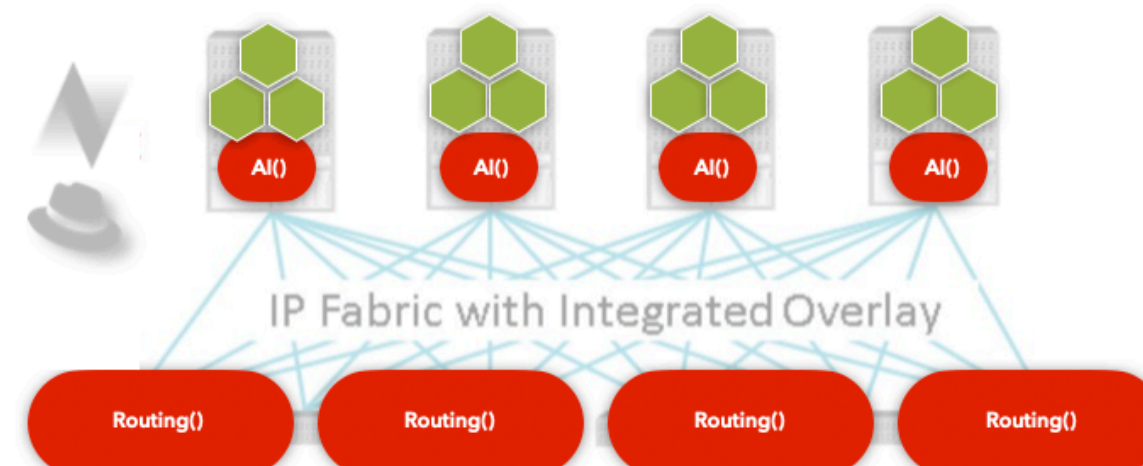

EID Routing for COIN AI Edge

1. *EID Context*: Natively source-routable logical data-index
2. *XTR Map*: Edge aggregation steers raw uploads to EIDs
3. *Lambda AI Reduce*: Apply `EID.context::functions(raw data)`
4. *MLD Subscribe*: to portable [Source, Theme] EID feeds
5. *Scales*: Ms of feeds via standard Signal-Free Multicast

Thank You