



# IETF 94 ROLL

## Routing over Low-Power And Lossy Networks

### **Chairs:**

Michael Richardson

Ines Robles



# Note Well

Any submission to the IETF intended by the Contributor for publication as all or part of an IETF Internet-Draft or RFC and any statement made within the context of an IETF activity is considered an "IETF Contribution". Such statements include oral statements in IETF sessions, as well as written and electronic communications made at any time or place, which are addressed to:

- The IETF plenary session
- The IESG, or any member thereof on behalf of the IESG
- Any IETF mailing list, including the IETF list itself, any working group or design team list, or any other list functioning under IETF auspices
- Any IETF working group or portion thereof
- Any Birds of a Feather (BOF) session
- The IAB or any member thereof on behalf of the IAB
- The RFC Editor or the Internet-Drafts function

All IETF Contributions are subject to the rules of [RFC 5378](#) and [RFC 3979](#) (updated by [RFC 4879](#)).

Statements made outside of an IETF session, mailing list or other function, that are clearly not intended to be input to an IETF activity, group or function, are not IETF Contributions in the context of this notice. Please consult [RFC 5378](#) and [RFC 3979](#) for details.

A participant in any IETF activity is deemed to accept all IETF rules of process, as documented in Best Current Practices RFCs and IESG Statements.

A participant in any IETF activity acknowledges that written, audio and video records of meetings may be made and may be available to the public.

Source: <https://www.ietf.org/about/note-well.html>

# Meeting Materials

- Remote Participation
  - Jabber Room: [roll@jabber.ietf.org](mailto:roll@jabber.ietf.org)
  - Meetecho: <http://www.meetecho.com/ietf94/roll>
- Etherpad:
  - <http://tools.ietf.org/wg/roll/minutes>
- Audio Streaming:
- Minutes taker:
- Jabber Scribe:
- **Please sign blue sheets :-)**

# Agenda

- State of: (20 minutes)
  - Work item
  - ROLL I-D
  - Related I-D
  - Open Issues
- draft-robles-roll-useofrplinfo-02 (20 min)
- draft-thubert-roll-dao-projection-02 (10 min)
- Open floor (10 minute)

## Milestones (cont.)

<b>Milestone</b>	<b>Schedule</b>
Submit draft about when to use RFC 6553, RFC 6554, and IPv6-in-IPv6 encapsulation to the IESG.	Aug 2015
Submit draft about how to compress RFC 6553, RFC 6554, and IP headers in the 6LoWPAN adaptation layer context to the IESG.	Nov 2015
Evaluate WG progress, recharter or close	Nov 2015

# State of Active Internet-Drafts

<b>draft-ietf-roll-admin-local-policy-03</b>	RFC Editor Queue
<b>draft-ietf-roll-applicability-ami-11</b>	Ready to be submitted to IESG
<b>draft-ietf-roll-applicability-home-building-12</b>	RFC Editor Queue
<b>draft-ietf-roll-applicability-template-07</b>	Stable - not to be published
<b>draft-ietf-roll-trickle-mcast-12</b>	RFC Editor Queue
<b>draft-ietf-roll-mpl-parameter-configuration-08</b>	New version should address comments of IESG

# Related Internet-Drafts

draft-robles-roll-useofrplinfo-02	When to use RFC 6553, 6554 and IPv6-in-IPv6	<a href="#">Slides Today</a>
draft-thubert-roll-dao-projection-02	Root initiated routing state in RPL	<a href="#">Slides Today</a>
draft-tan-roll-clustering-00	RPL-based Clustering Routing Protocol	Future Discussion
draft-turner-roll-dio-ctx-00	RPL DIO Option for Specifying Compression Contexts	Future Discussion
draft-wang-roll-adaptive-data-aggregation	Design of Adaptive Data Aggregation Schemes	Future Discussion
draft-zhong-roll-dis-modifications-00	DIS Modifications	Future Discussion

# Open Tickets

Ticket	Summary
<a href="#">#169</a>	Work Item Proposals
<a href="#">#170</a>	Use of ESC Dispatch value in new IETF header compression



# RPL RPI/RH3 uses

draft-robles-roll-useofrpi

Michael Richardson  
Pascal Thubert  
Ines Robles

# structure of network - reference diagram

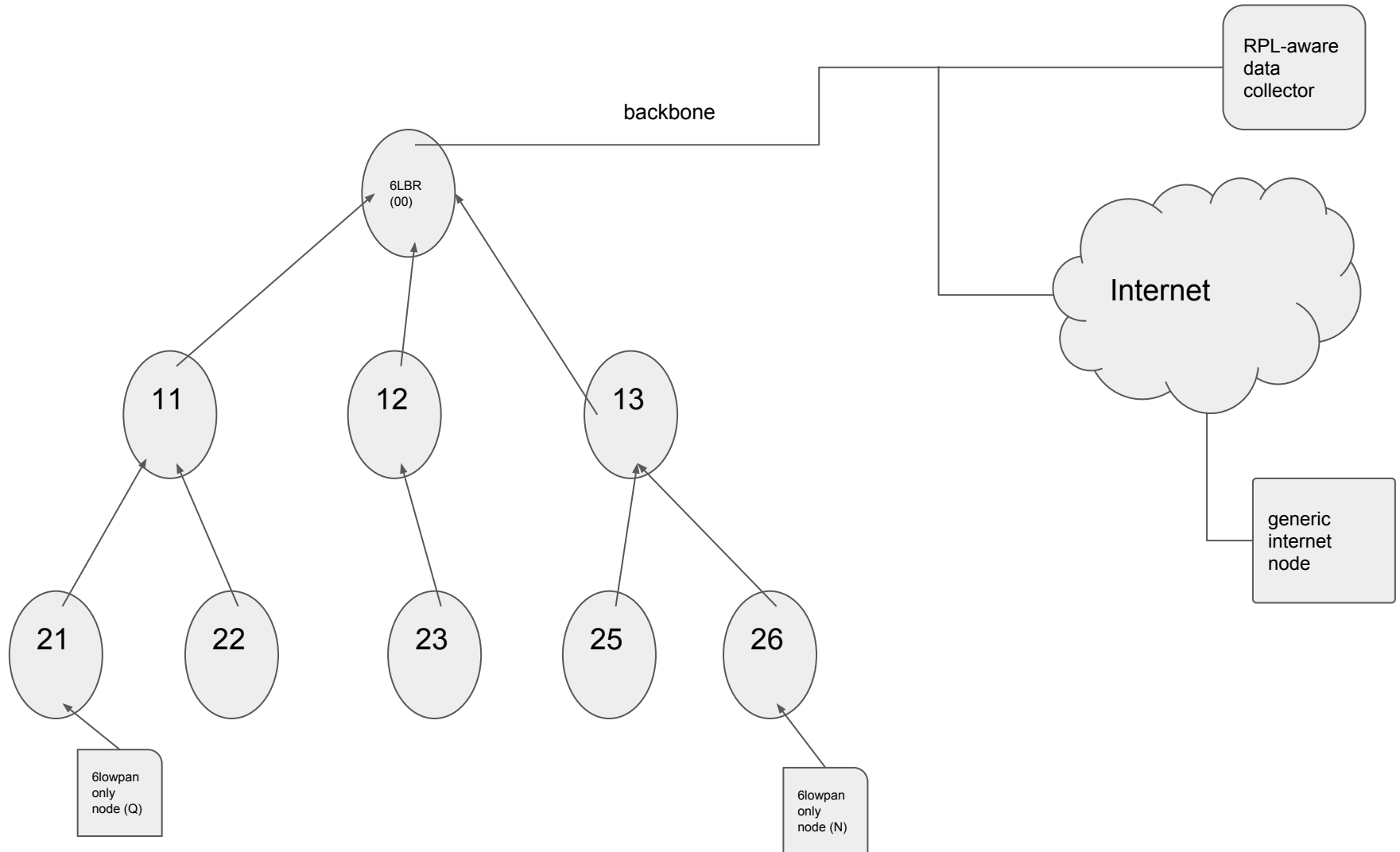

# RPL Domain Architecture

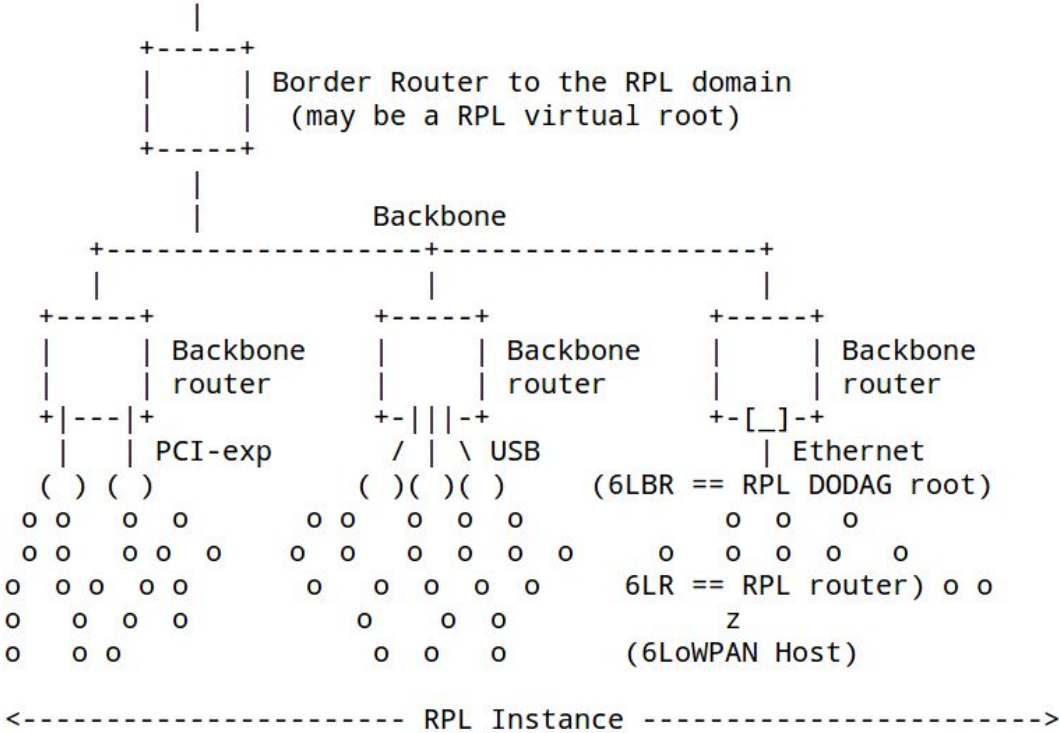

# Rules for the Proposed Scenarios

-This document assumes a rule that a **Header cannot be inserted or removed on the fly inside an IPv6 packet that is being routed.**

- This means that an **intermediate router that needs to add a header must encapsulate the packet in an outer IP header where the new header can be placed.**

- This also means that a Header can only be removed by an intermediate router if

- it is placed in an encapsulating IPv6 Header,
- and that the IPv6 header is \*addressed\* to that intermediate router!

The whole encapsulating header must be removed - a replacement may be added though.

- **RPI should be present in every single RPL data packet**

the **rank** is important, especially in storing-mode, even if there is only one RPLinstanceID

There is an exception in non-storing mode, when a packet is going down from the route: the entire route is written, so there are no loops of confusion about which table to use (purpose of instanceID).

# Scenarios analyzed in draft-robles-roll-useofrpi work done at virtual interim working meeting, September 29.

{Storing,Non-Storing} X {RPL-aware-leaf,non-RPL-aware,root, Internet} X {RPL-aware-leaf,non-RPL-aware,root,Internet}

(but Internet->Internet cases removed, so 24, not 32)

## STORING

1. Flow from RPL-aware-leaf to root
2. Flow from root to RPL-aware-leaf
3. Flow from non-RPL-aware-leaf to root
4. Flow from root to non-RPL-aware-leaf
5. Flow from RPL-aware-leaf to Internet
6. Flow from Internet to RPL-aware-leaf
7. Flow from non-RPL-aware-leaf to Internet
8. Flow from Internet to non-RPL-aware-leaf
9. Flow from RPL-aware-leaf to RPL-aware-leaf
10. Flow from RPL-aware-leaf to non-RPL-aware-leaf
11. Flow from non-RPL-aware-leaf to RPL-aware-leaf
12. Flow from non-RPL-aware-leaf to non-RPL-aware-leaf

## NON-STORING

13. Flow from RPL-aware-leaf to root
14. Flow from root to RPL-aware-leaf
15. Flow from non-RPL-aware-leaf to root
16. Flow from root to non-RPL-aware-leaf
17. Flow from RPL-aware-leaf to Internet
18. Flow from Internet to RPL-aware-leaf
19. Flow from non-RPL-aware-leaf to Internet
20. Flow from Internet to non-RPL-aware-leaf
21. Flow from RPL-aware-leaf to RPL-aware-leaf
22. Flow from RPL-aware-leaf to non-RPL-aware-leaf
23. Flow from non-RPL-aware-leaf to RPL-aware-leaf
24. Flow from non-RPL-aware-leaf to non-RPL-aware-leaf

no problems: storing-mode, Flow from RPL-aware-leaf to root

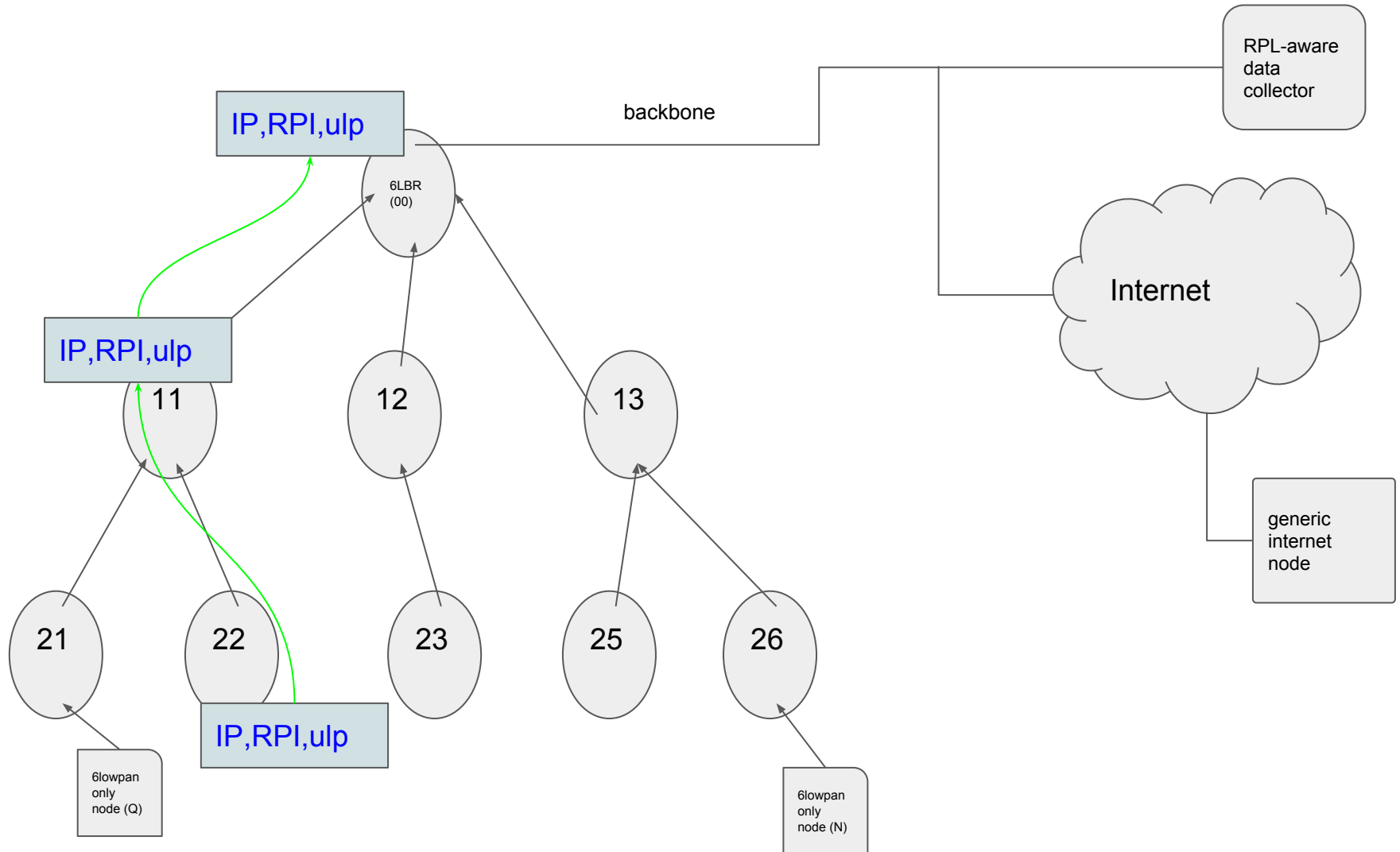

ulp - upper layer payload/protocol (e.g. UDP, TCP, etc.)

# few problems: storing-mode, Flow from RPL-aware-leaf to Internet

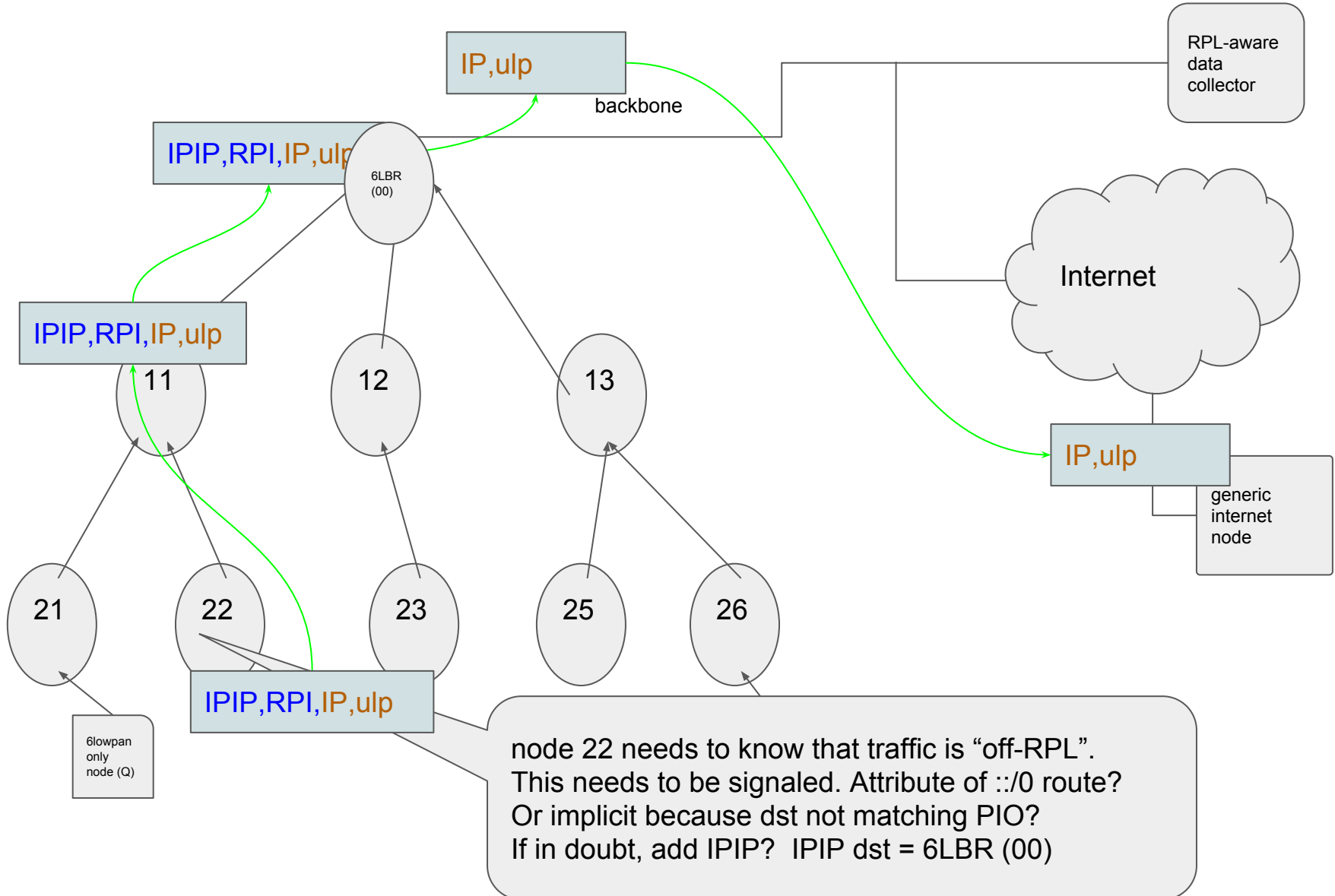

# few problems: non-storing-mode Internet to non-RPL-aware-Leaf

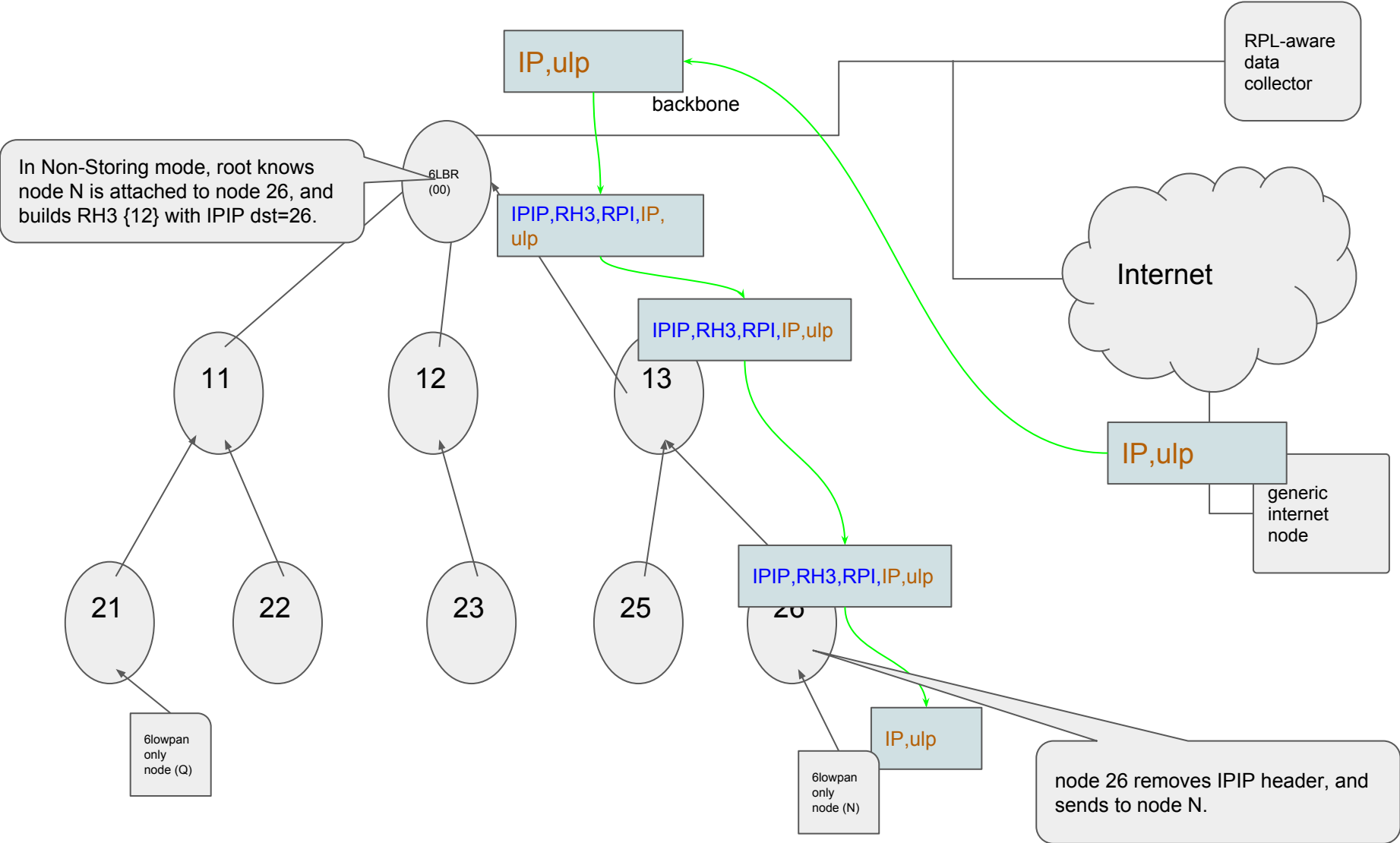



# big problems: storing-mode Internet to non-RPL-aware-Leaf

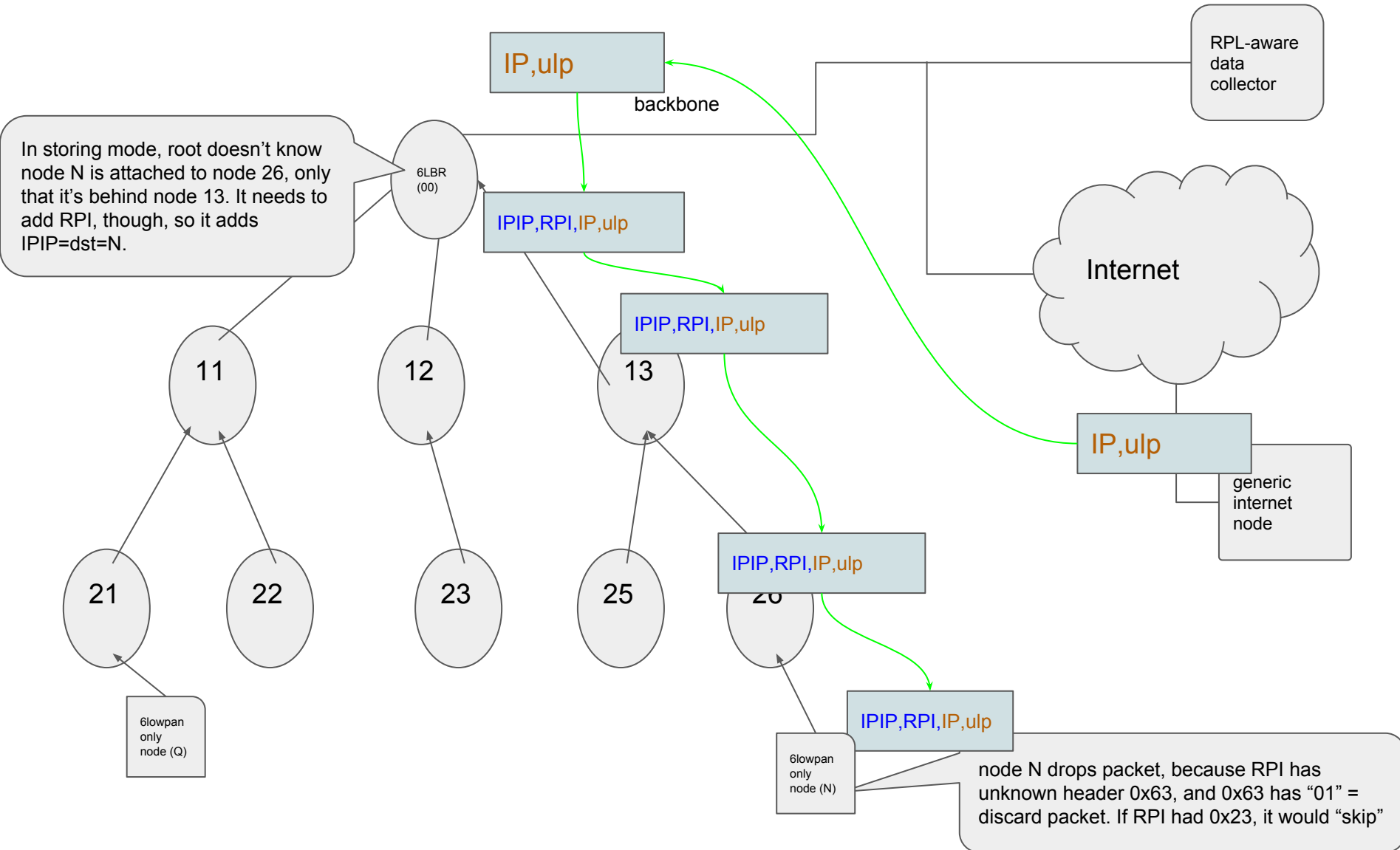

# no problems: non-storing-mode from RPL-aware-leaf to RPL-aware-leaf

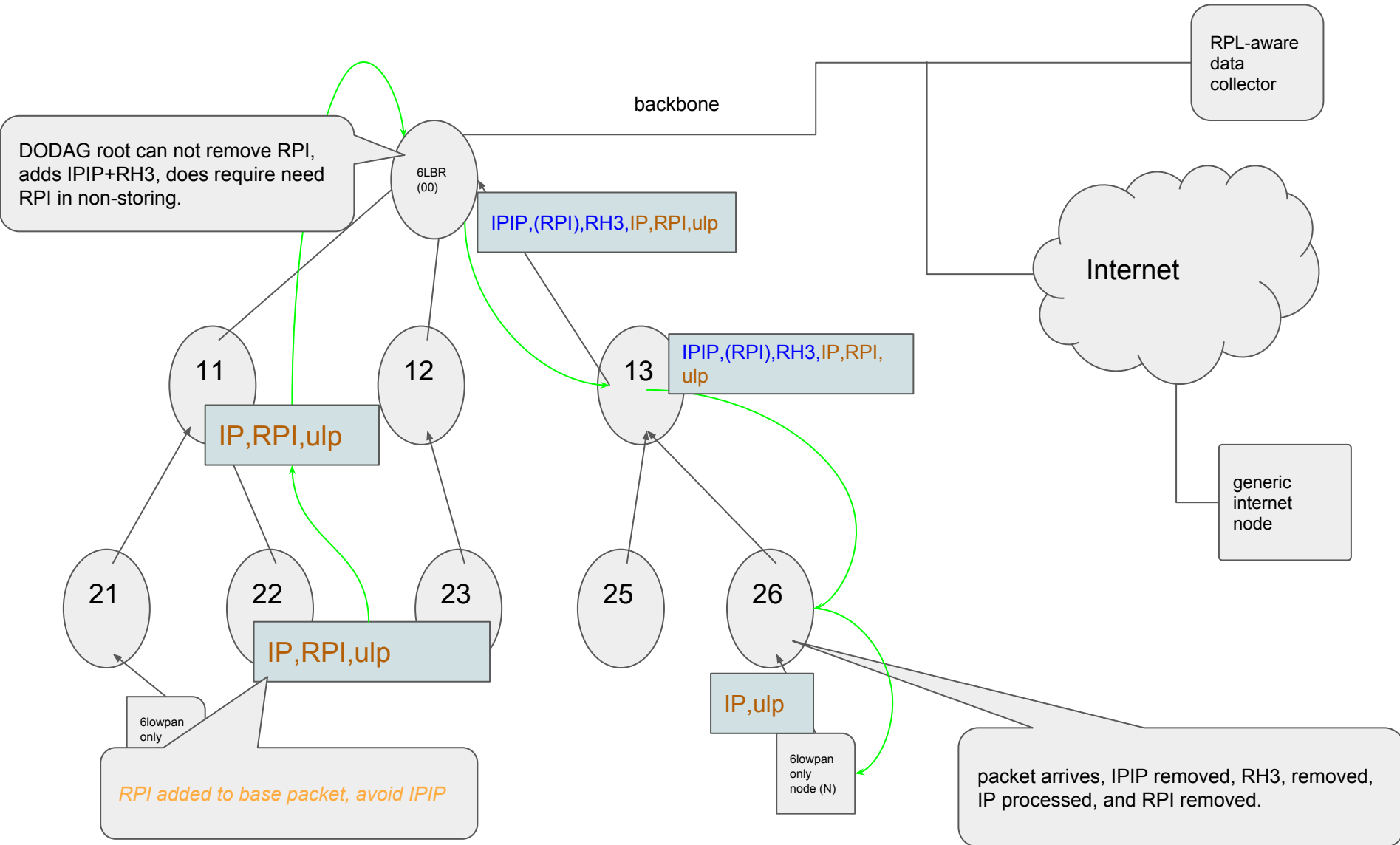

# few problems: non-storing-mode from RPL-aware-leaf to RPL-aware-leaf

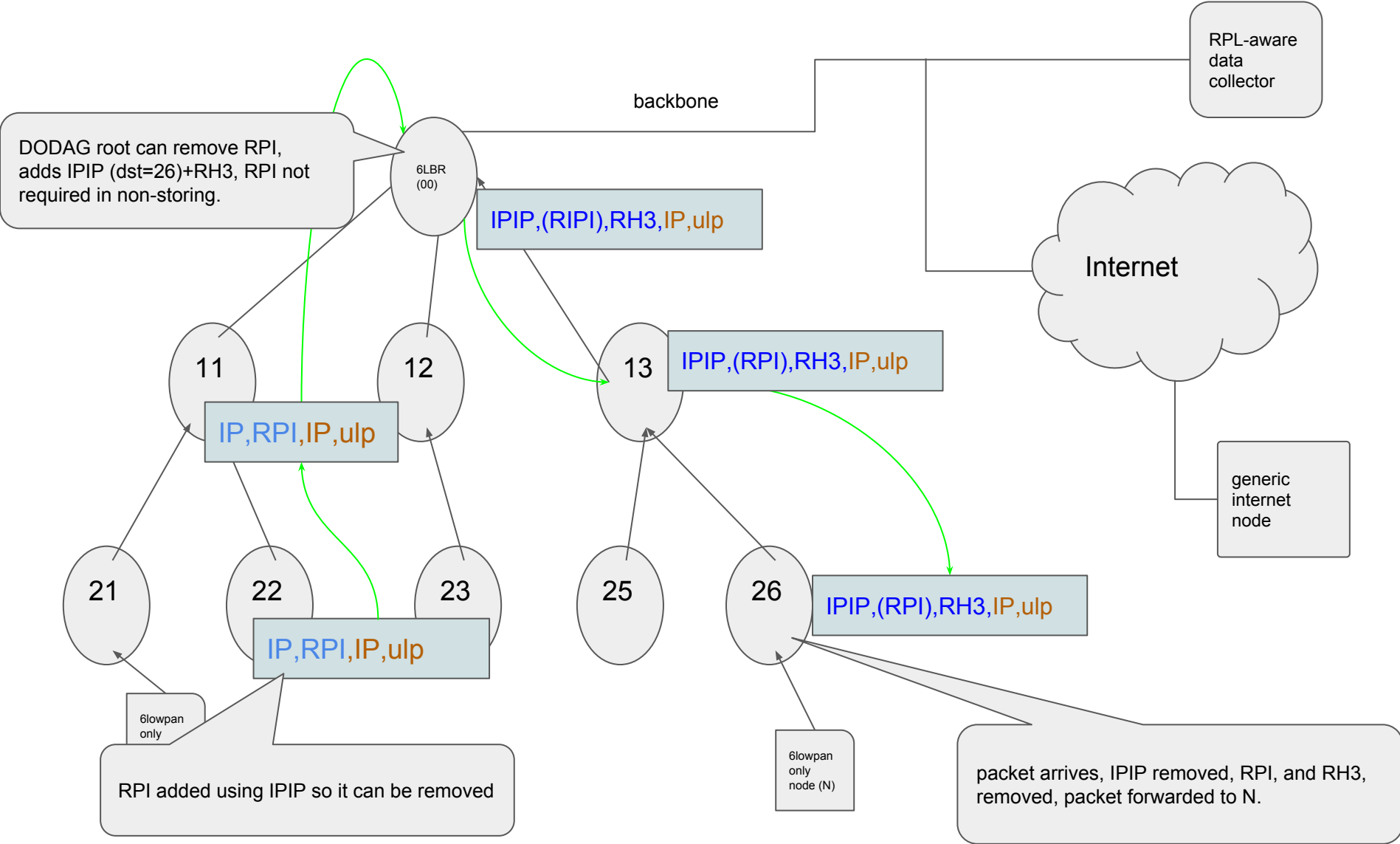

## Case that Fails: Storing From RPL aware to Non-RPL aware

Somehow, the sender has to know that the receiver is not RPL aware, and needs to know 6LR, and not even the root knows where the 6LR is (in storing mode). This case **FAILS**.

6LN --> 6LR --> common parent (6LR) --> 6LR --> not-RPL-aware 6LN

## How to solve this?

# Future RPL work

There are cases from above that are not clear how to send the information. It requires further analysis on how to proceed to send the information from source to destination.

we have in storing mode:

- Flow from RPL-aware-leaf to non-RPL-aware-leaf: Somehow, the sender has to know that the receiver is not RPL aware, and needs to know 6LR, and not even the root knows where the 6LR is located.
- Flow from not-RPL-aware-leaf to not-RPL-aware-leaf: The problem to solve is how to indicate where to send the packet when get into LLN.

# Root initiated routing state in RPL

## draft-thubert-dao-projection

Pascal Thubert  
IETF 94

Yokohama, November 2025

# Highlights

- Allows for centralized routing computation with RPL  
E.g. Root coordinates with PCE
- Need topological information and / or device constraints  
e.g. how many routes can a given RPL router store?  
Can leverage TEAS / DETNET work  
Enough topology info in non-storing route optimization at the root
- New: Added support for transversal route  
Works for storing and non storing routes

# New generic route optimization





Application  
Server D

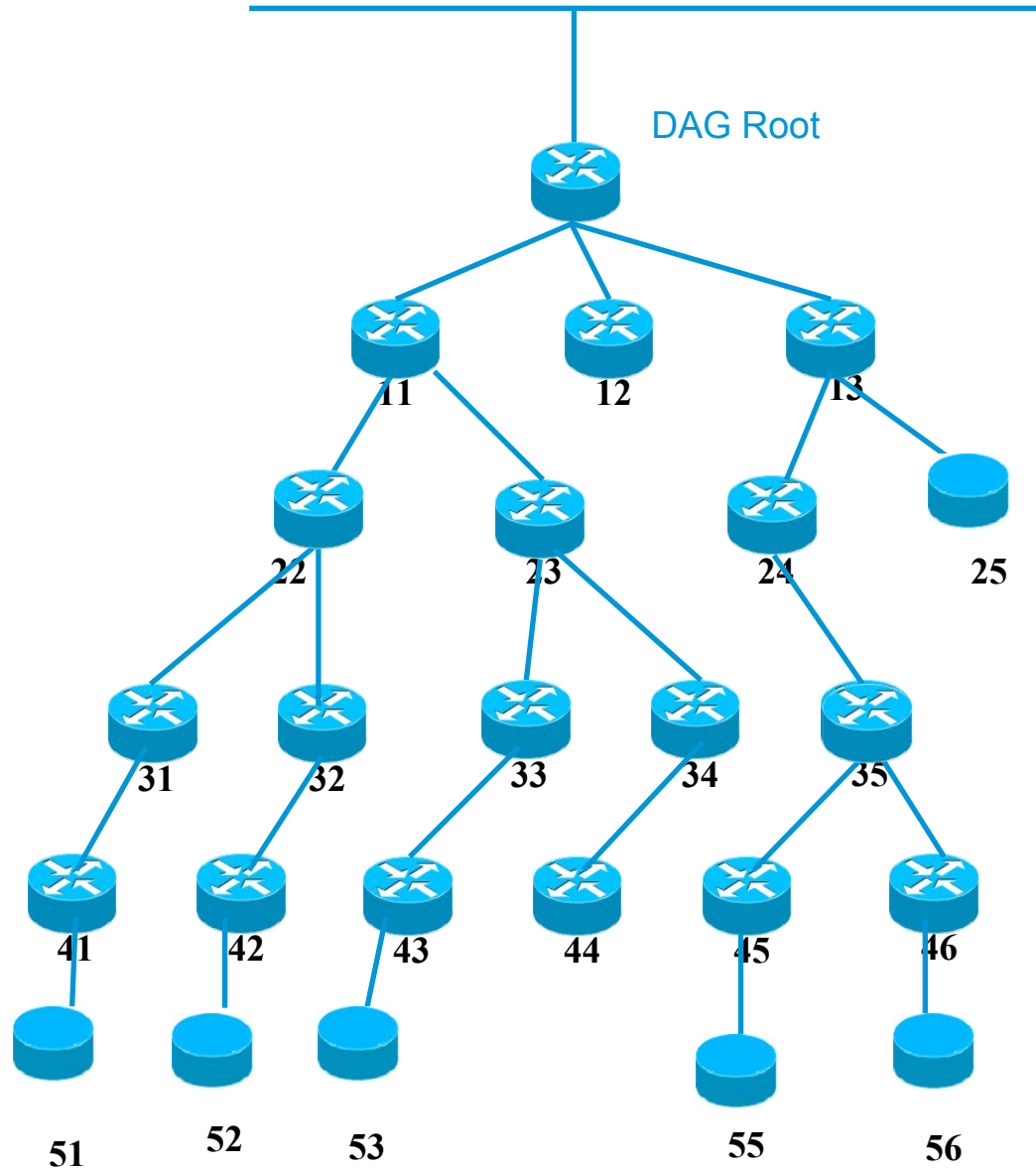



Application  
Server D

# Stretch in non-storing mode

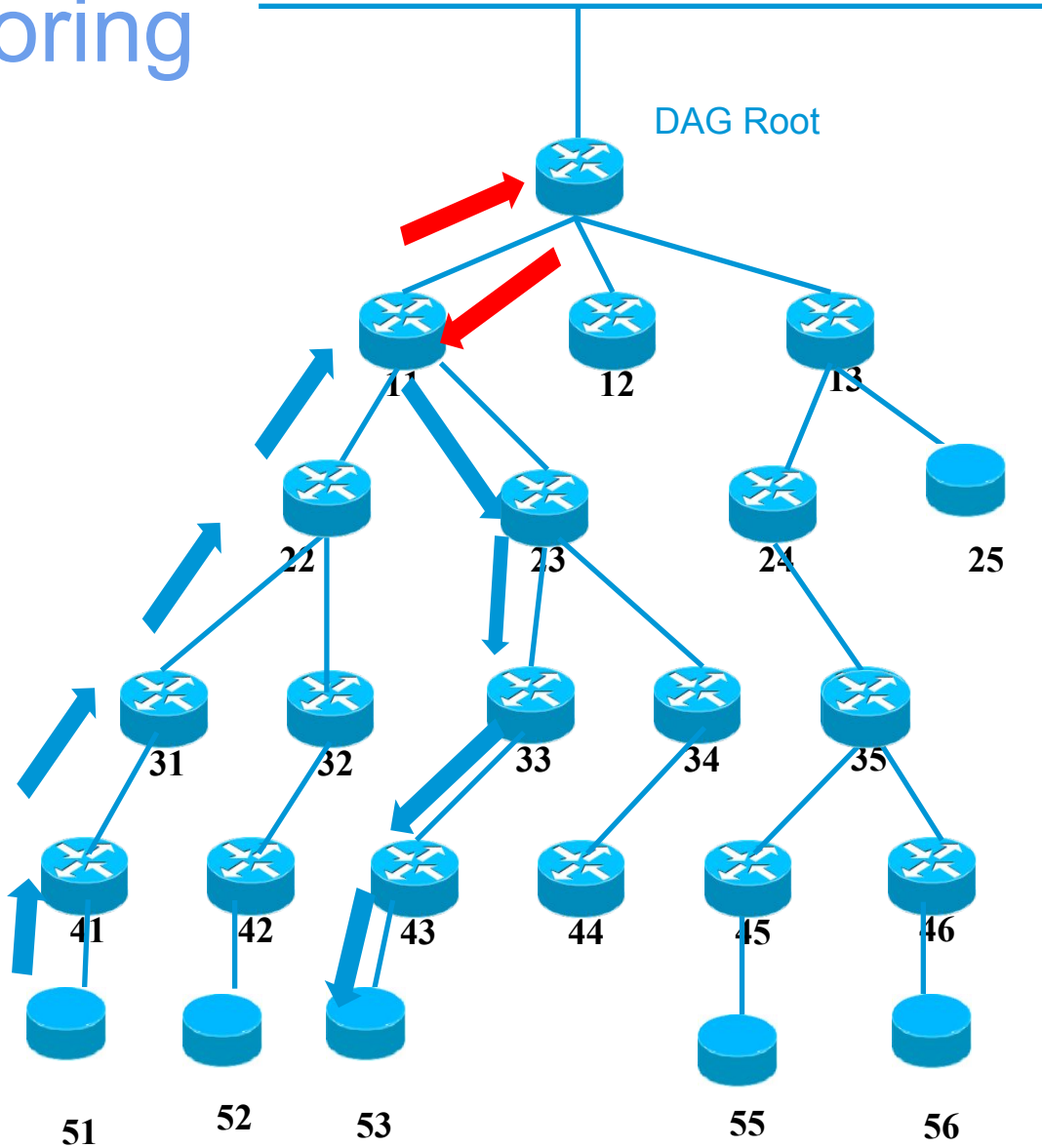



Application Server D

# Stretch in storing mode

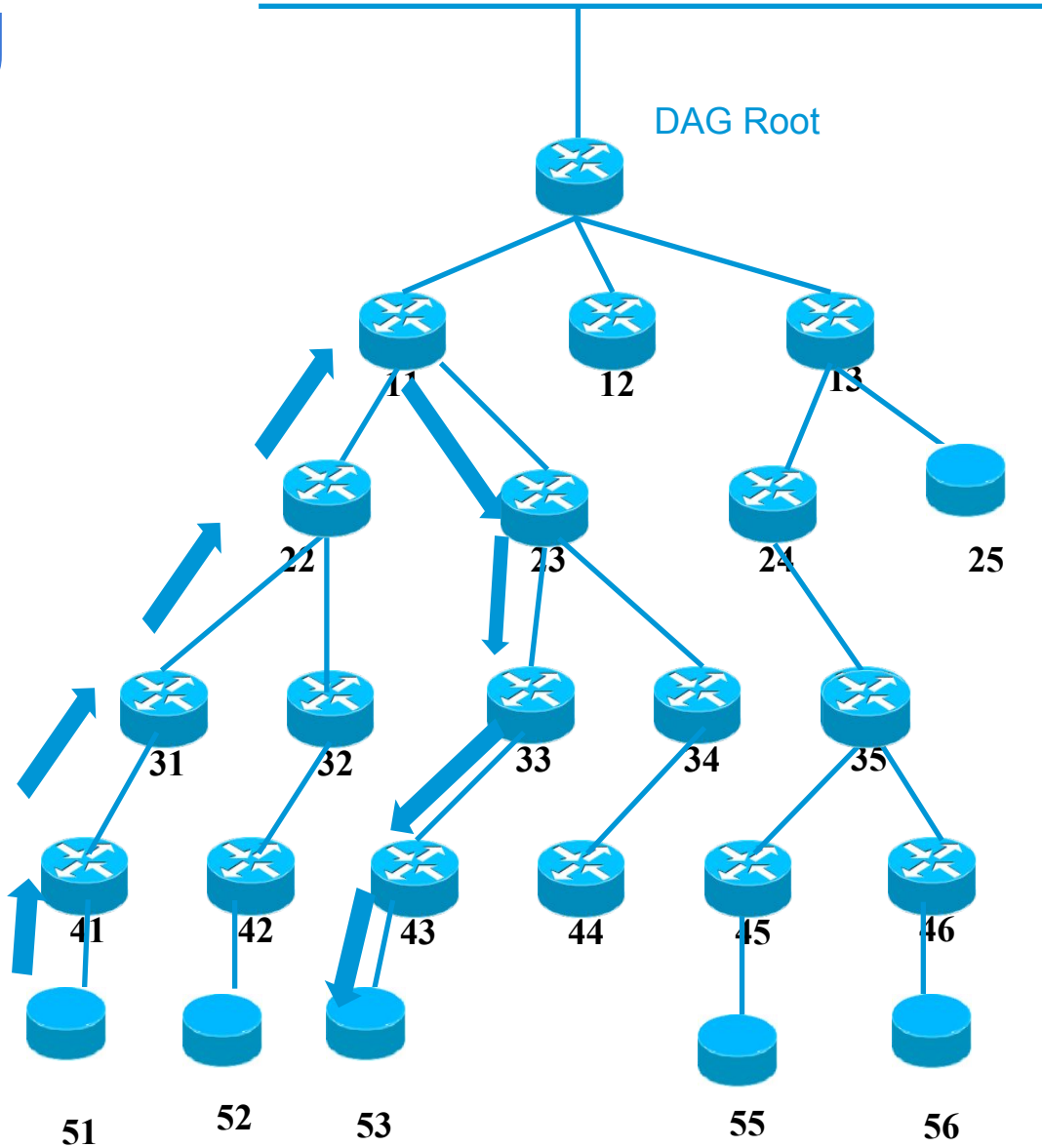



Application Server D

# DAO projection

New (projected) DAO with path segment unicast to target 53 via 41 (ingress), 42 and 43 (egress)

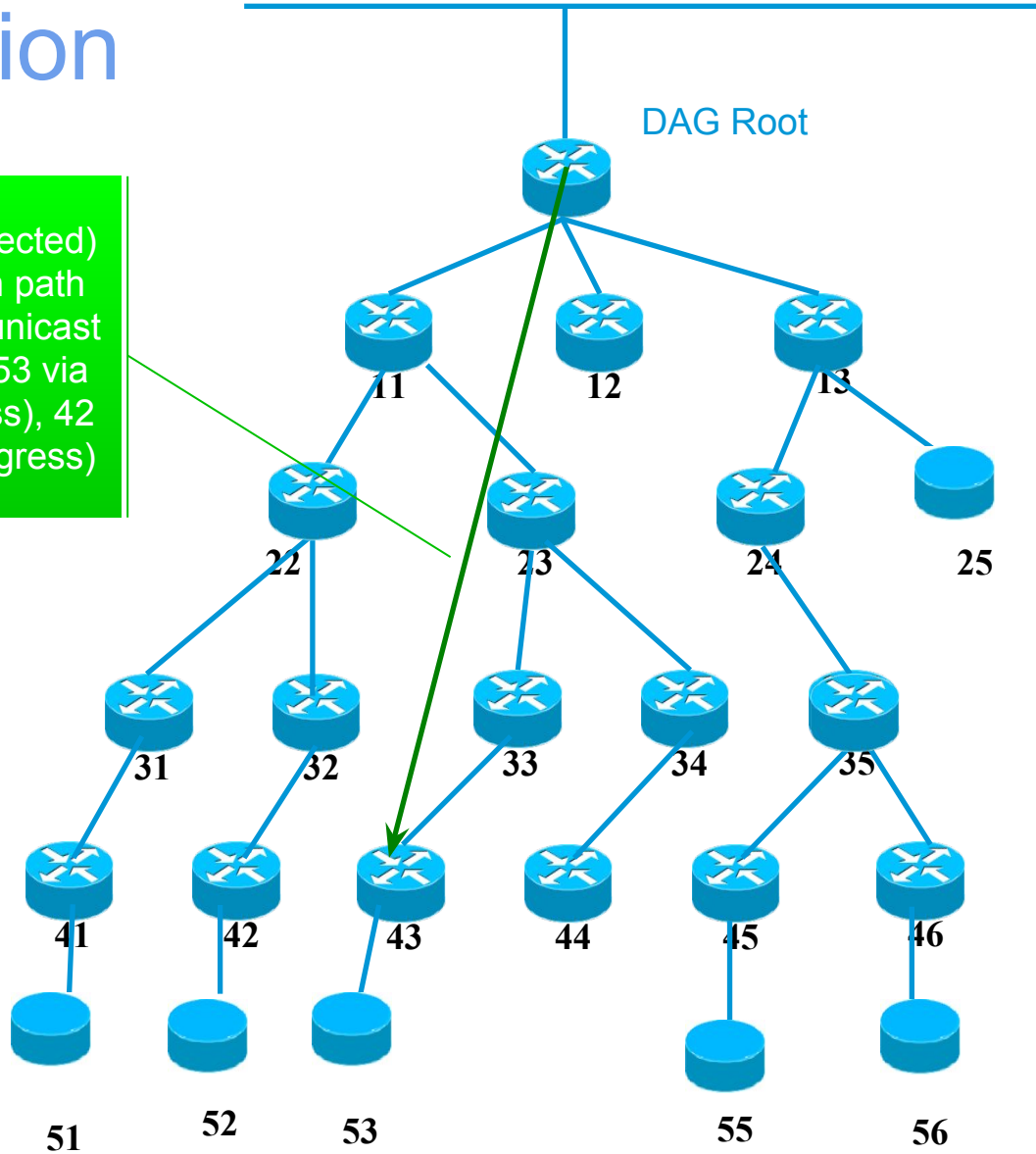



Application Server D

# DAO projection

Storing mode DAO (forced) with lifetime along segment

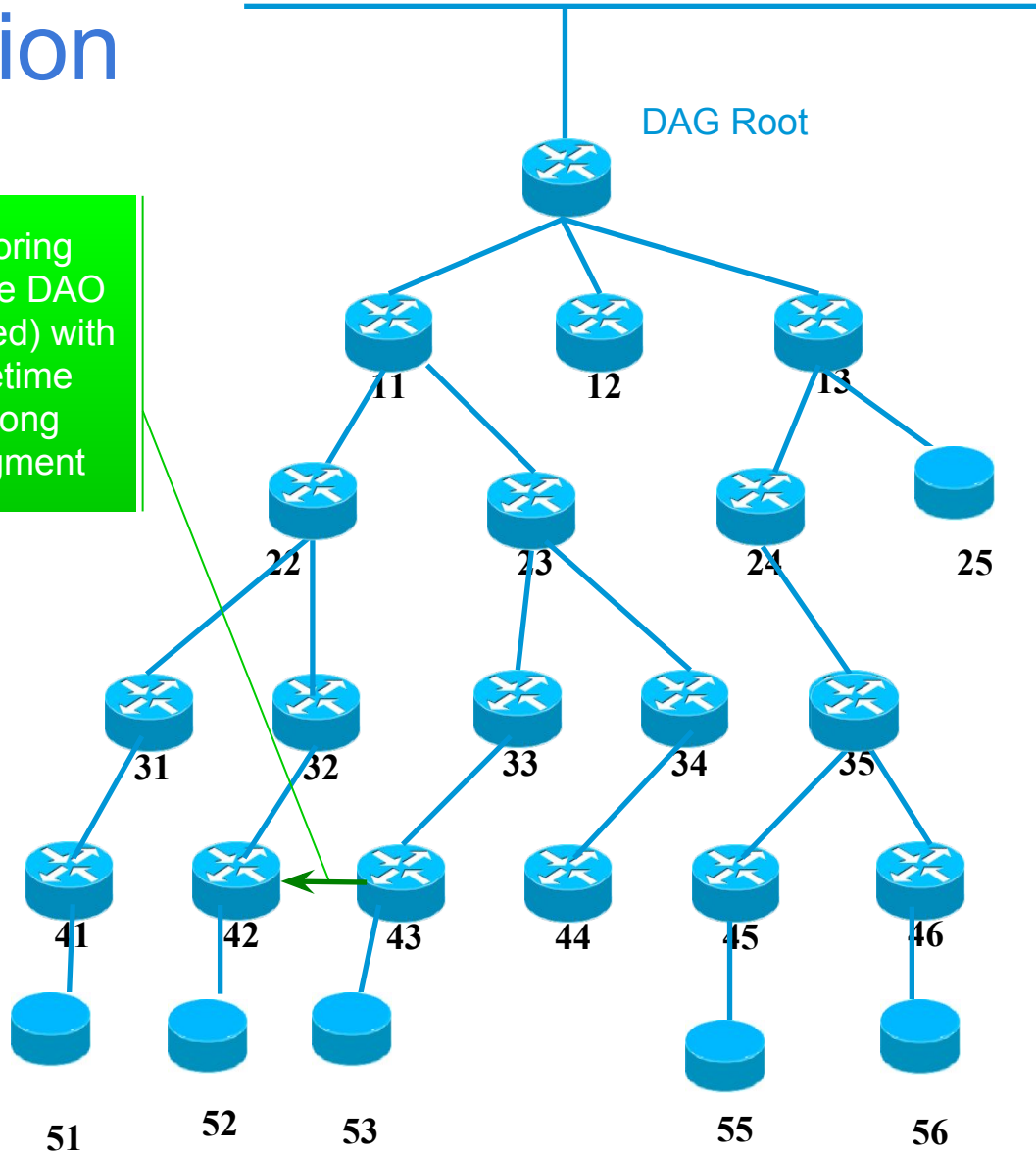



Application Server D

# DAO projection

Storing mode DAO (forced) with lifetime along segment

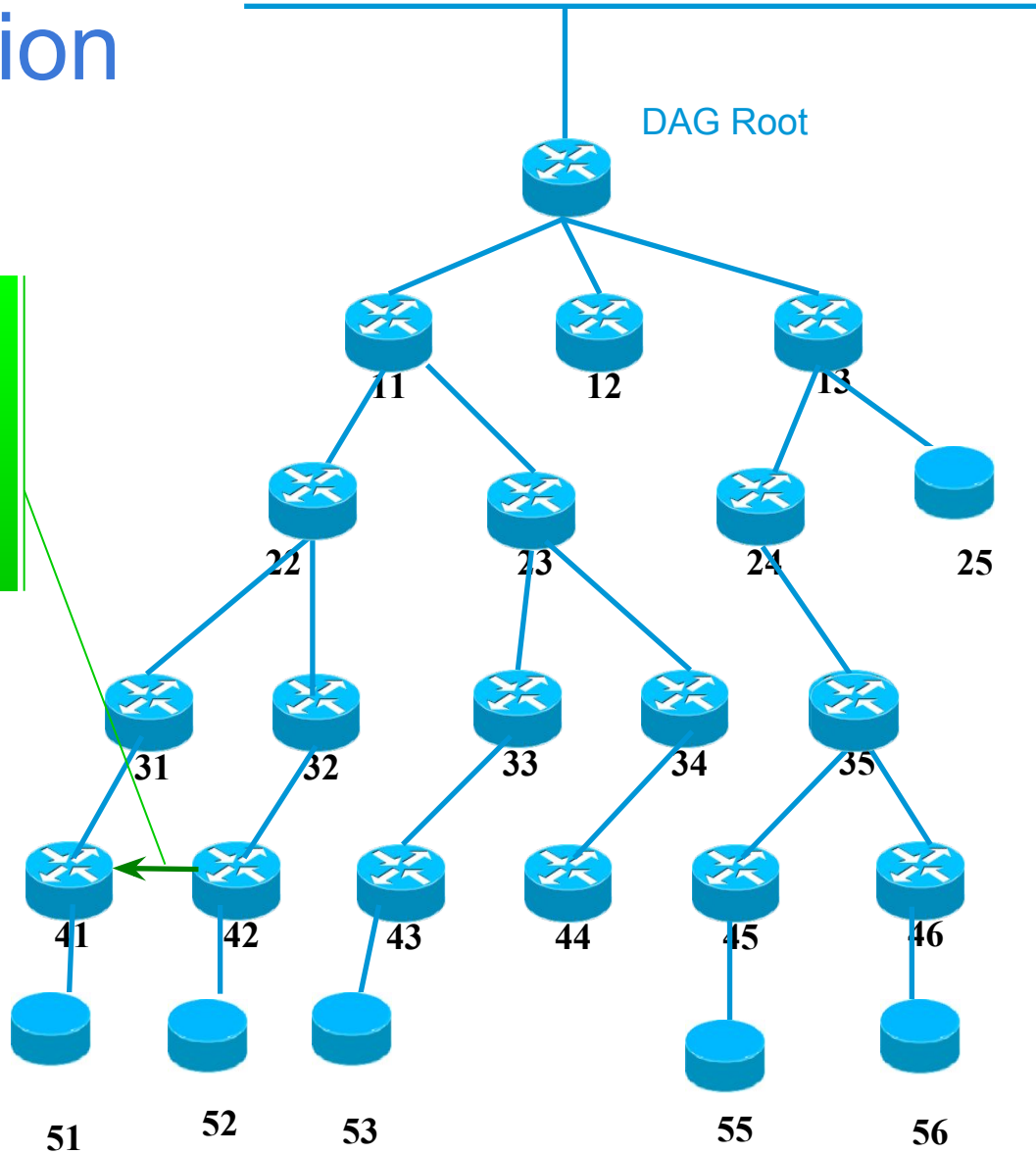



Application Server D

# DAO projection

DAO-ACK unicast, self 41 as parent, final destination 53 as target

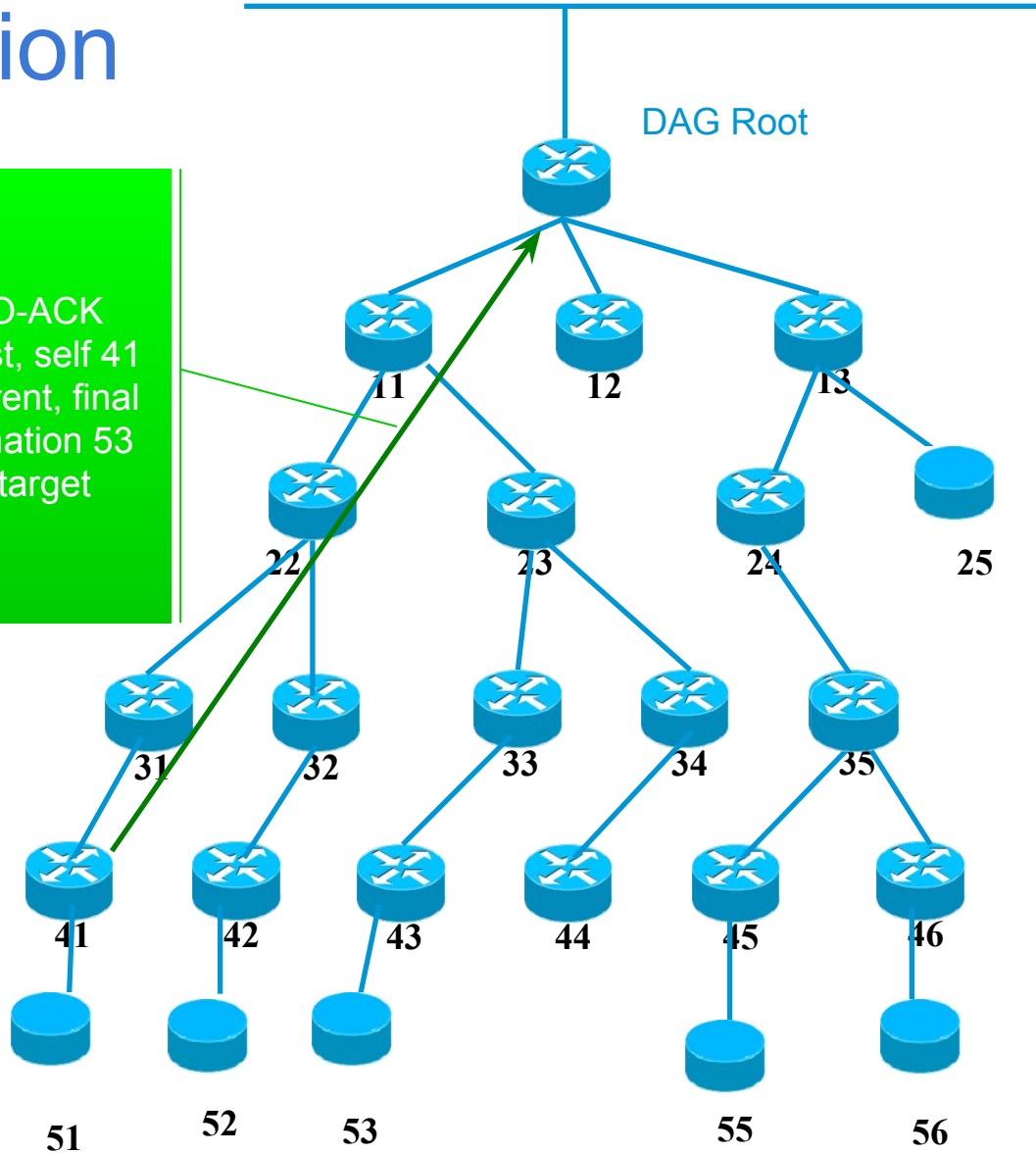



Application Server D

# Optimized Path

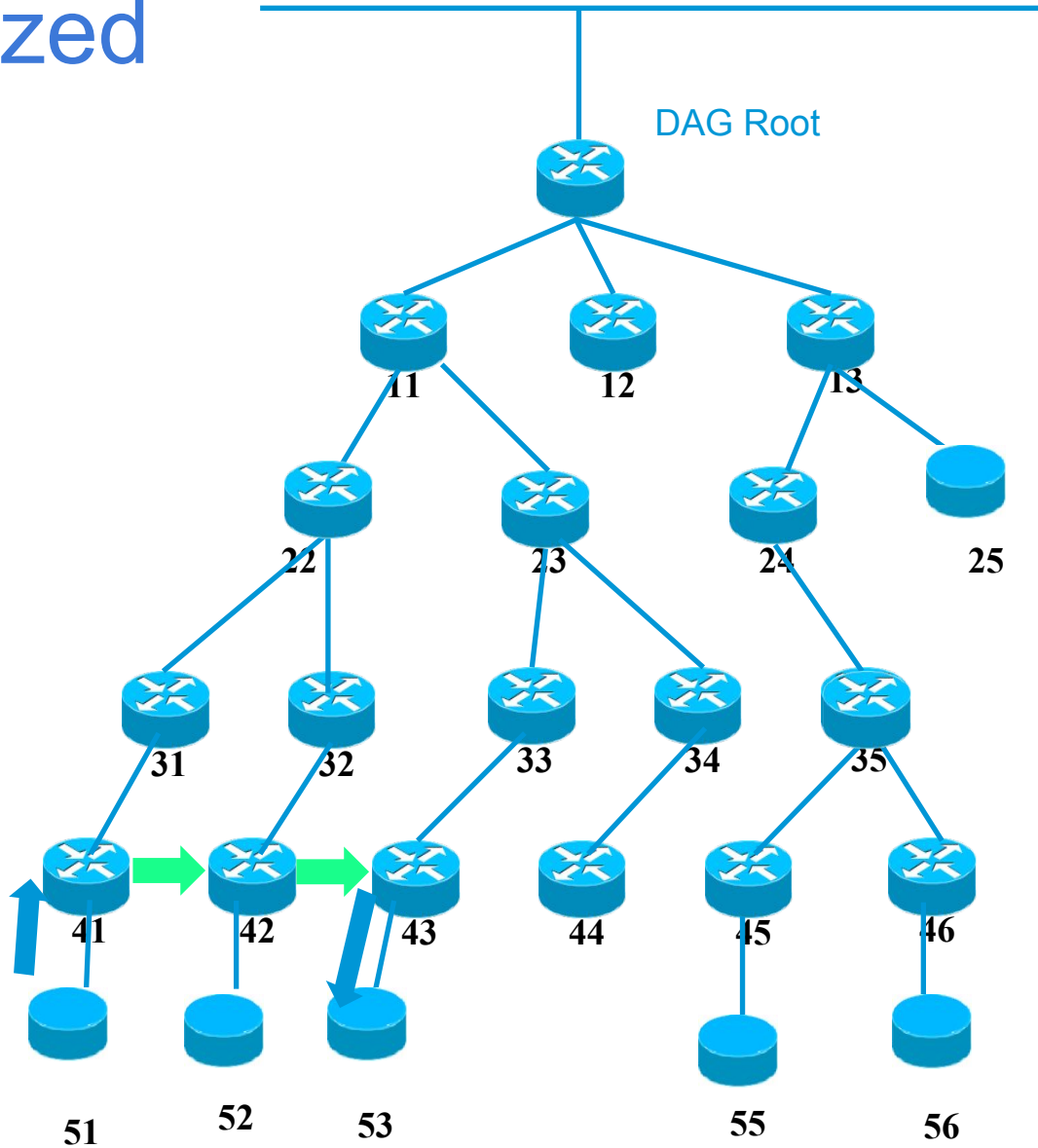



# Existing non storing optimization



Application  
Server D

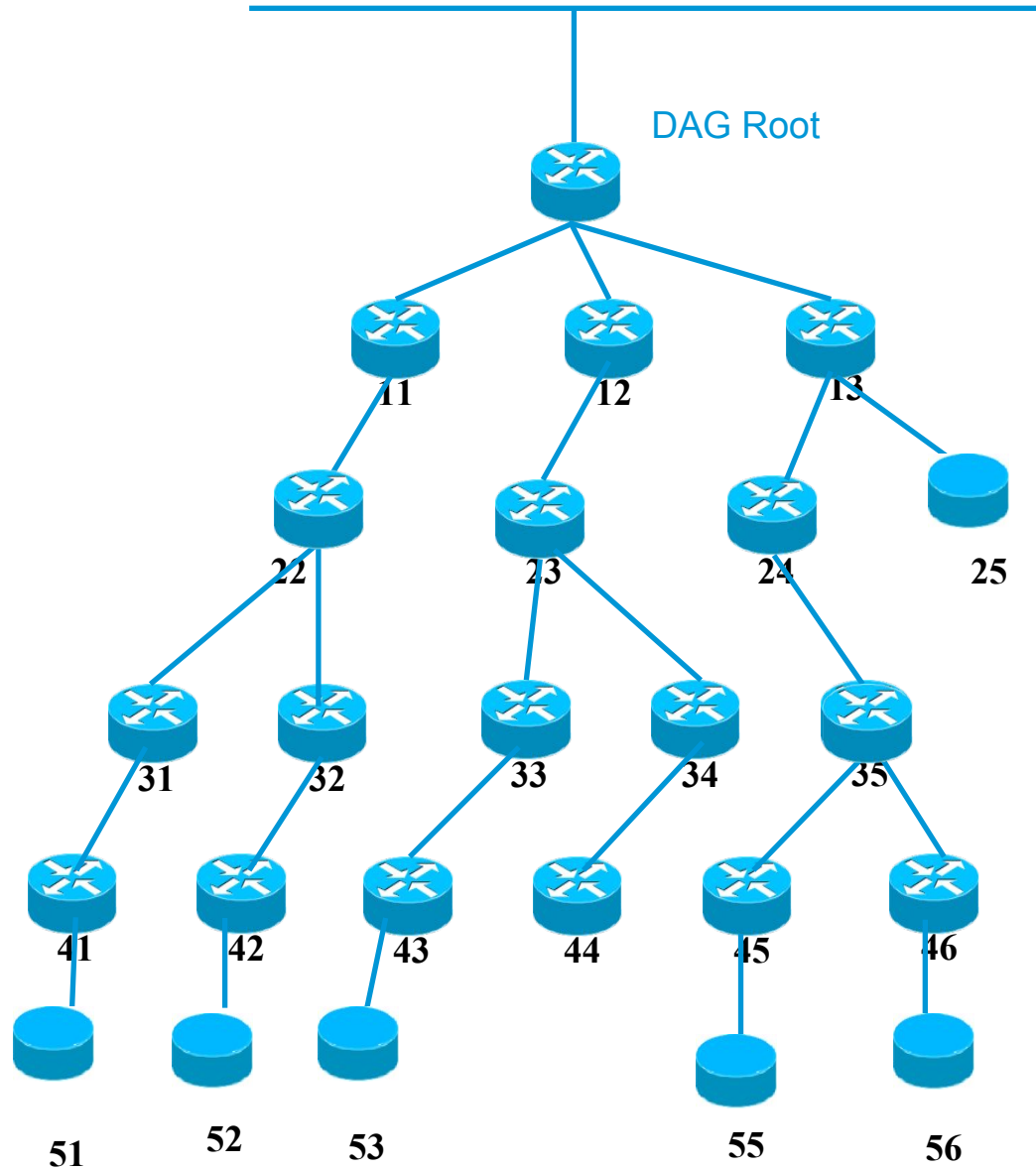



Application  
Server D

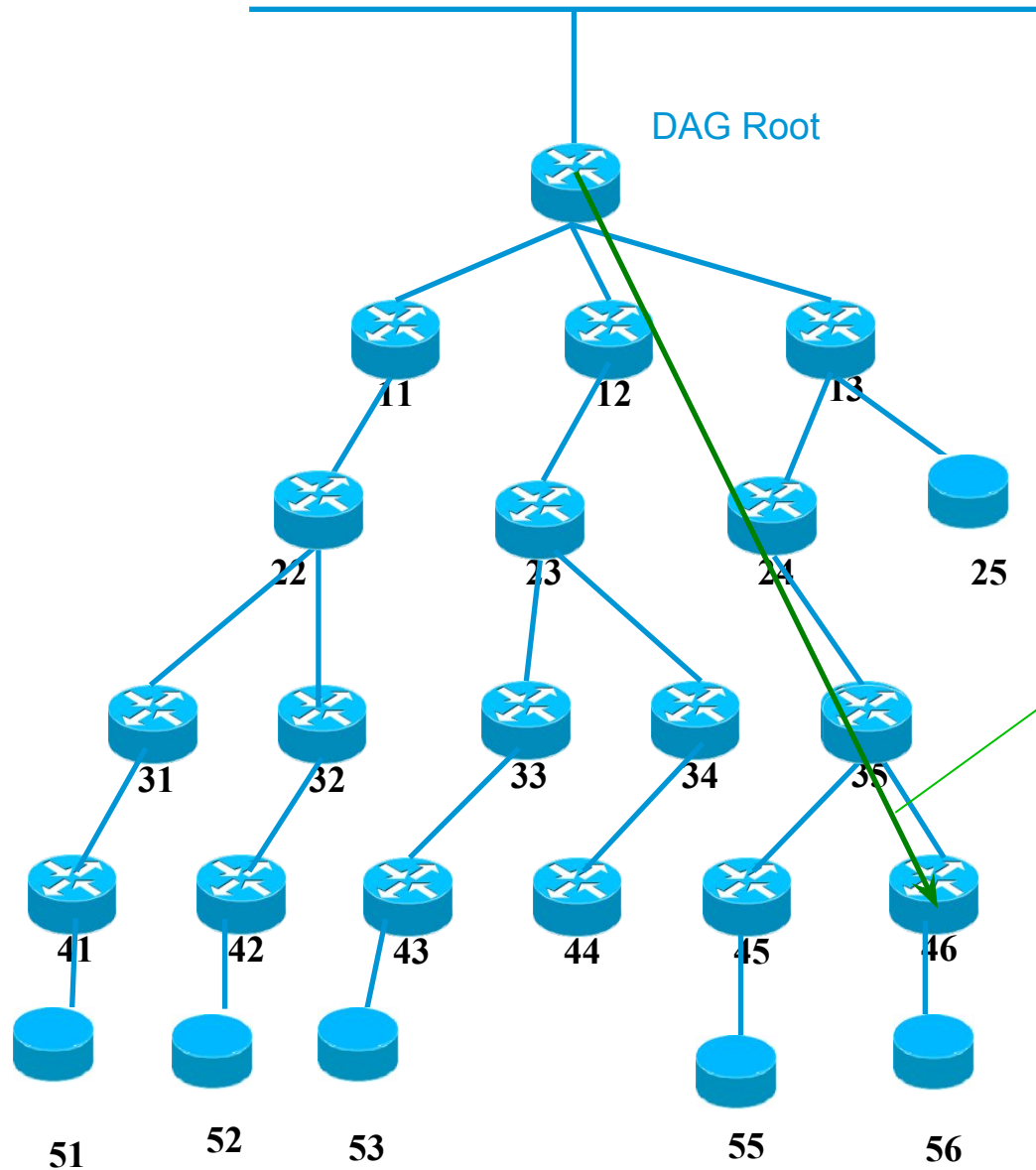

New (projected)  
DAO with path  
segment unicast  
to target 56 via  
35 (ingress) and  
46 (egress)



Application  
Server D

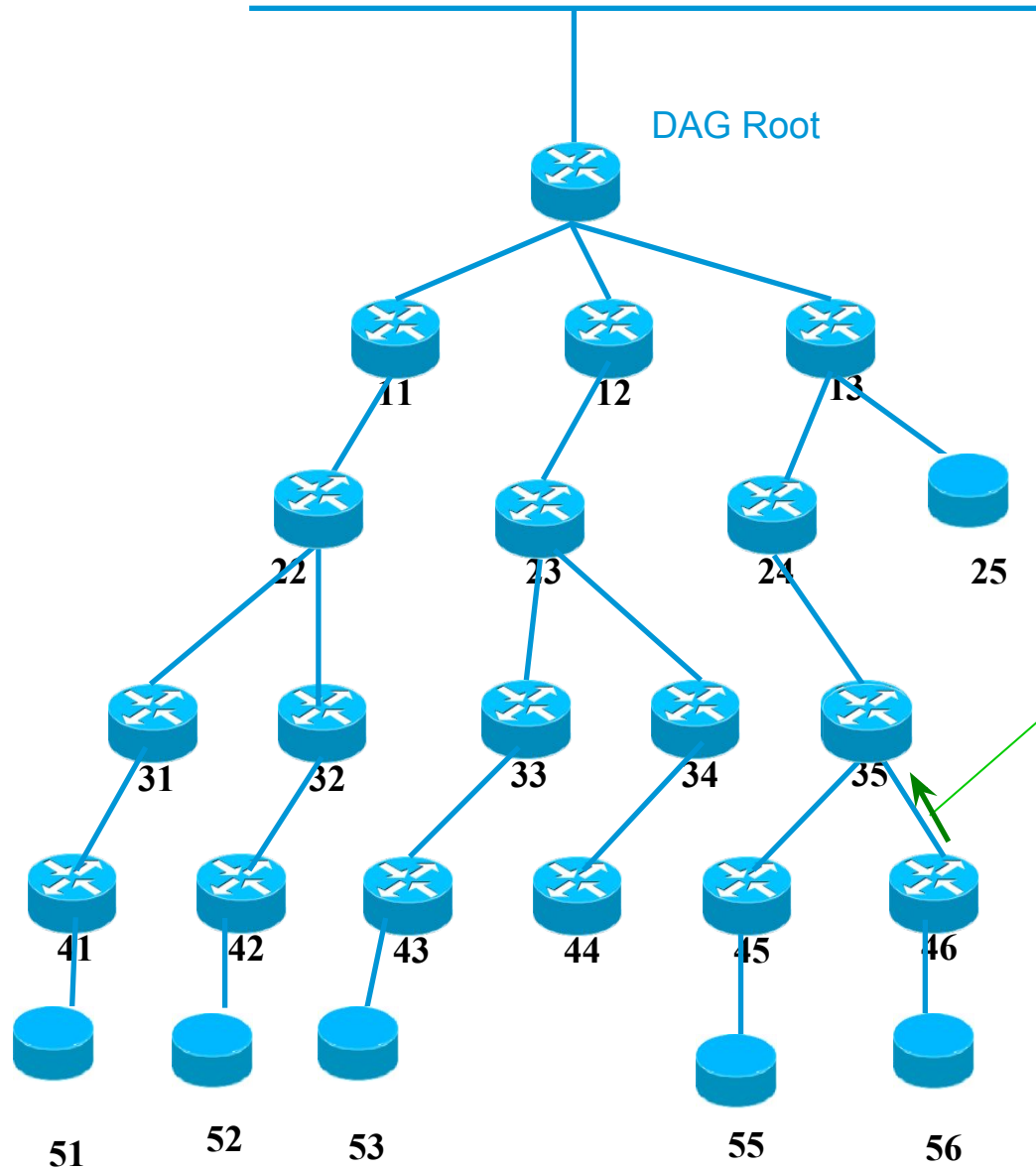

mode  
DAO  
(forced)  
with  
lifetime  
along



Application  
Server D

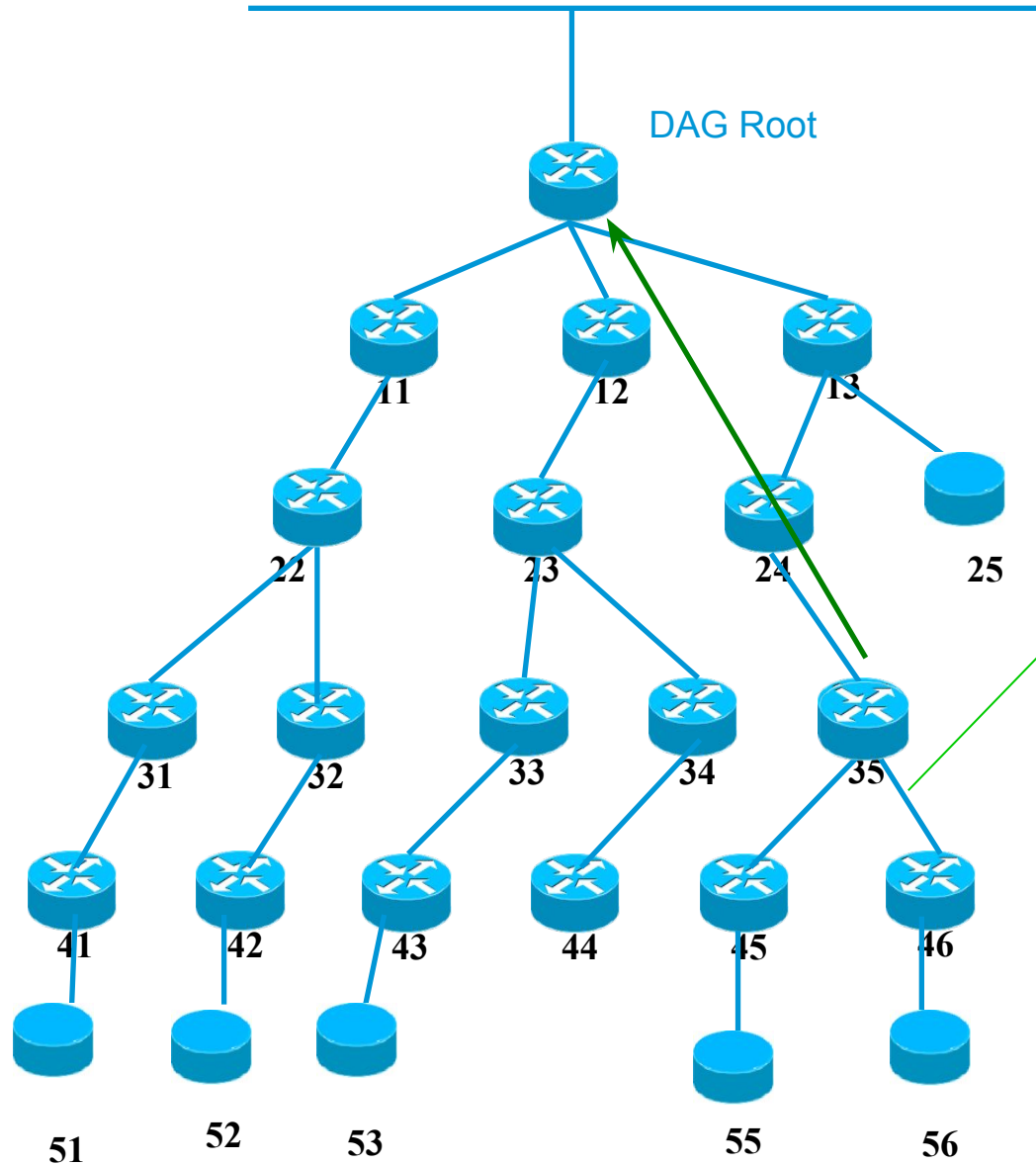

DAO-ACK (alt:  
non storing  
DAO) unicast,  
self 35 as  
parent, final  
destination 56  
as target



Application Server D

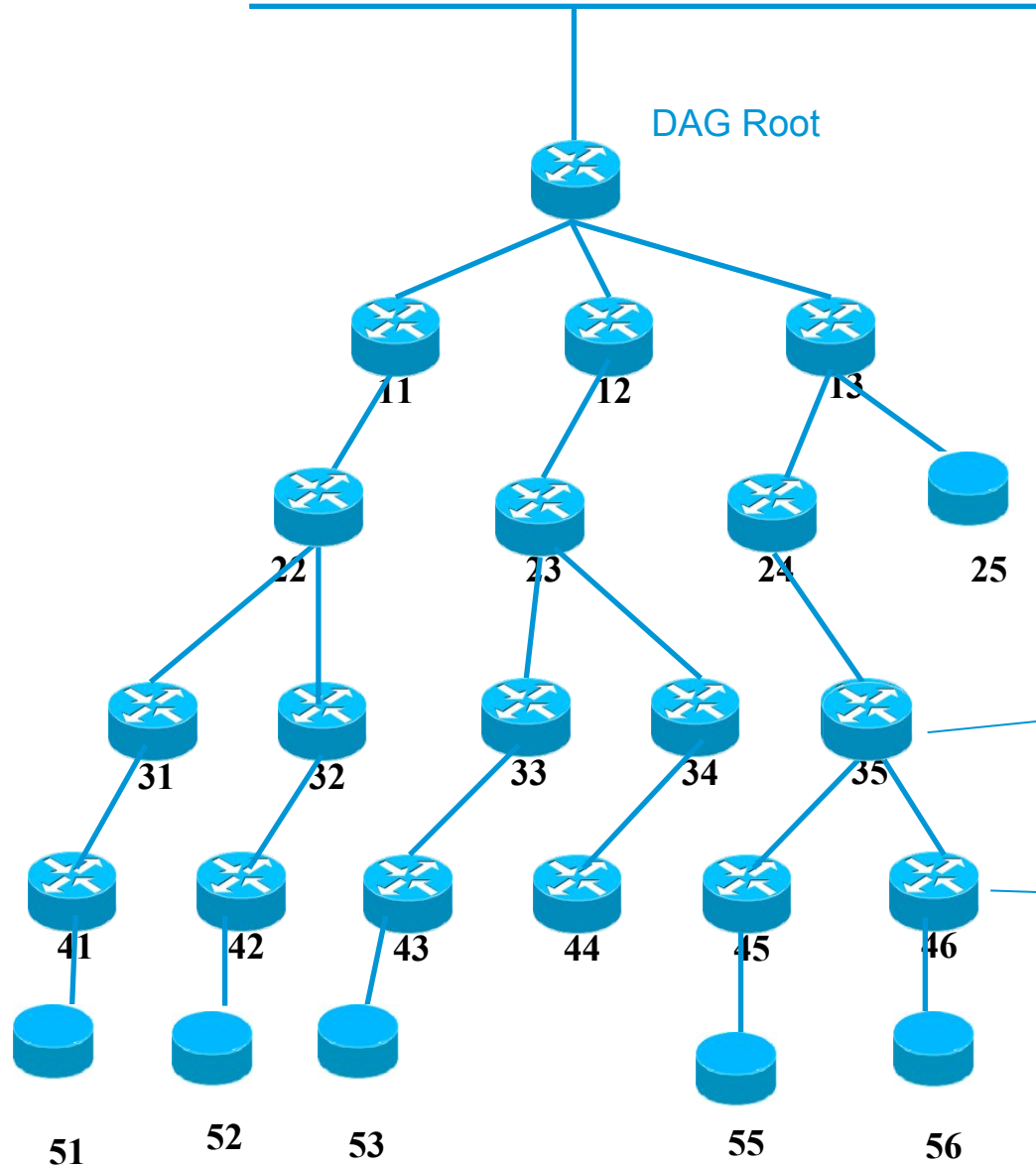

DAO from 46 installs a route to 56 in 35 (all nodes in projected route from ingress included to egress excluded) => egress should already have a route to target

56 via 46

Preexisting connected route to 56



Application Server D

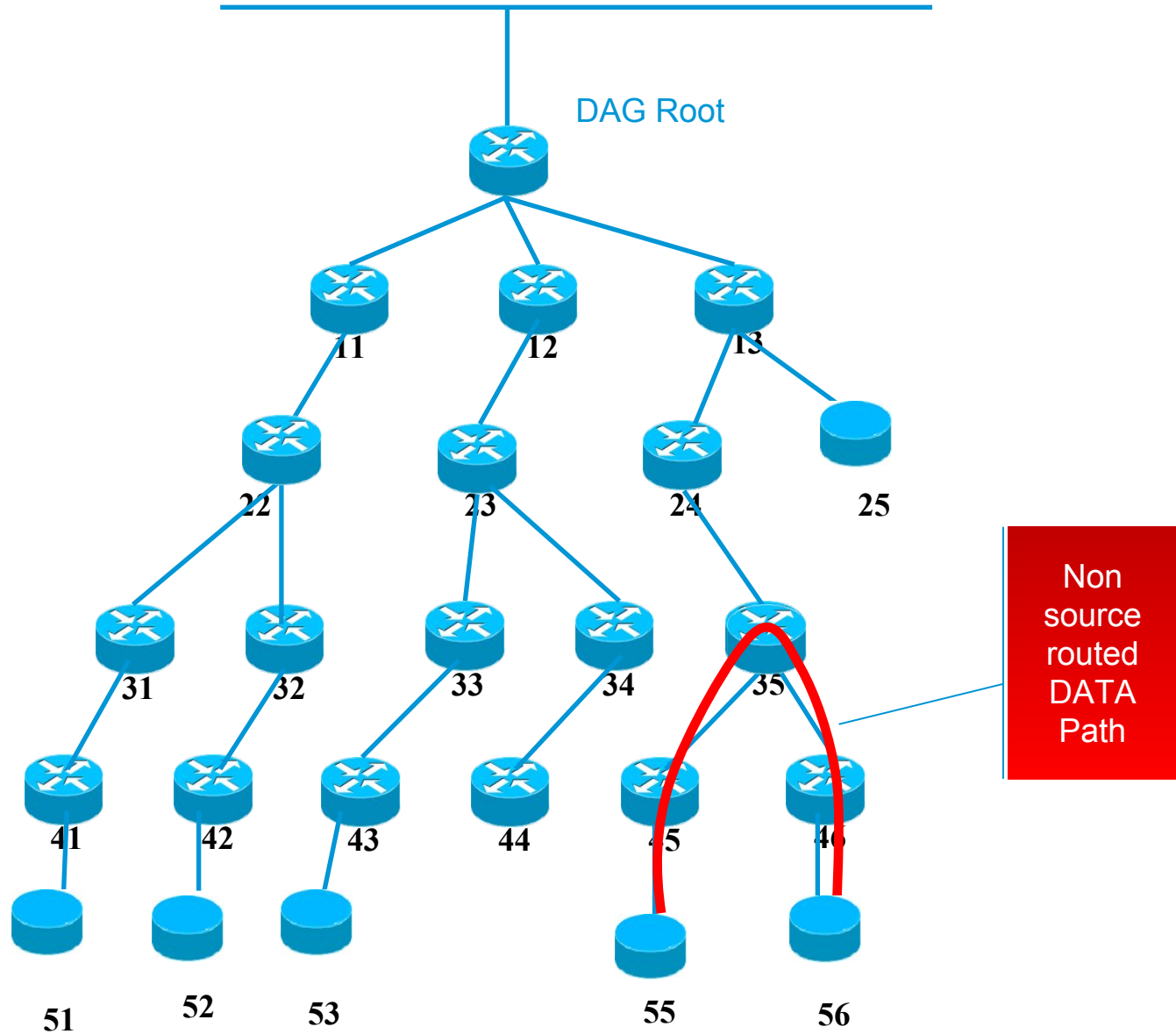



Application Server D

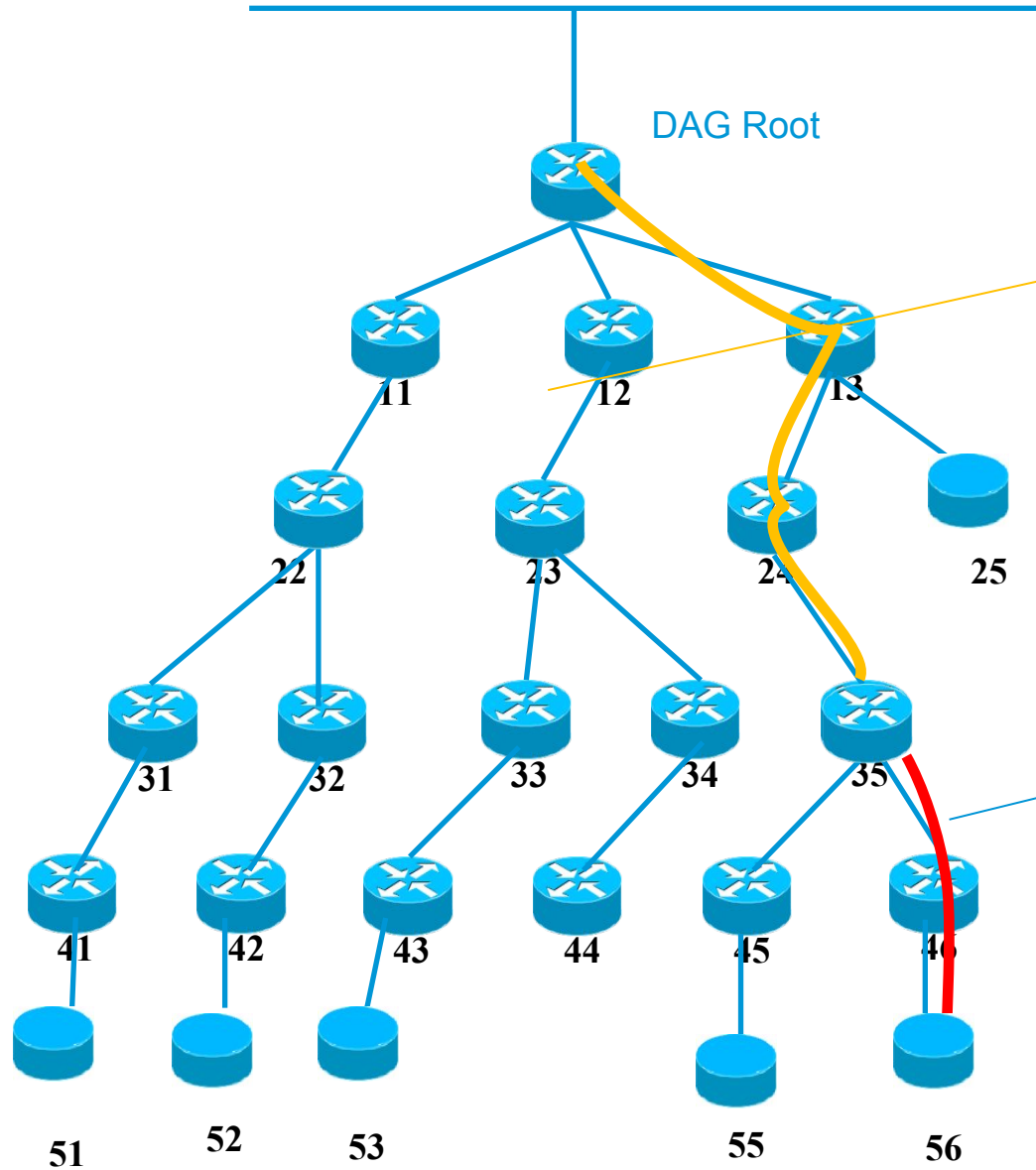

Loose Source routed DATA Path Packet to 13, RH 24, 35, 56

Non source routed DATA Path





Application Server D

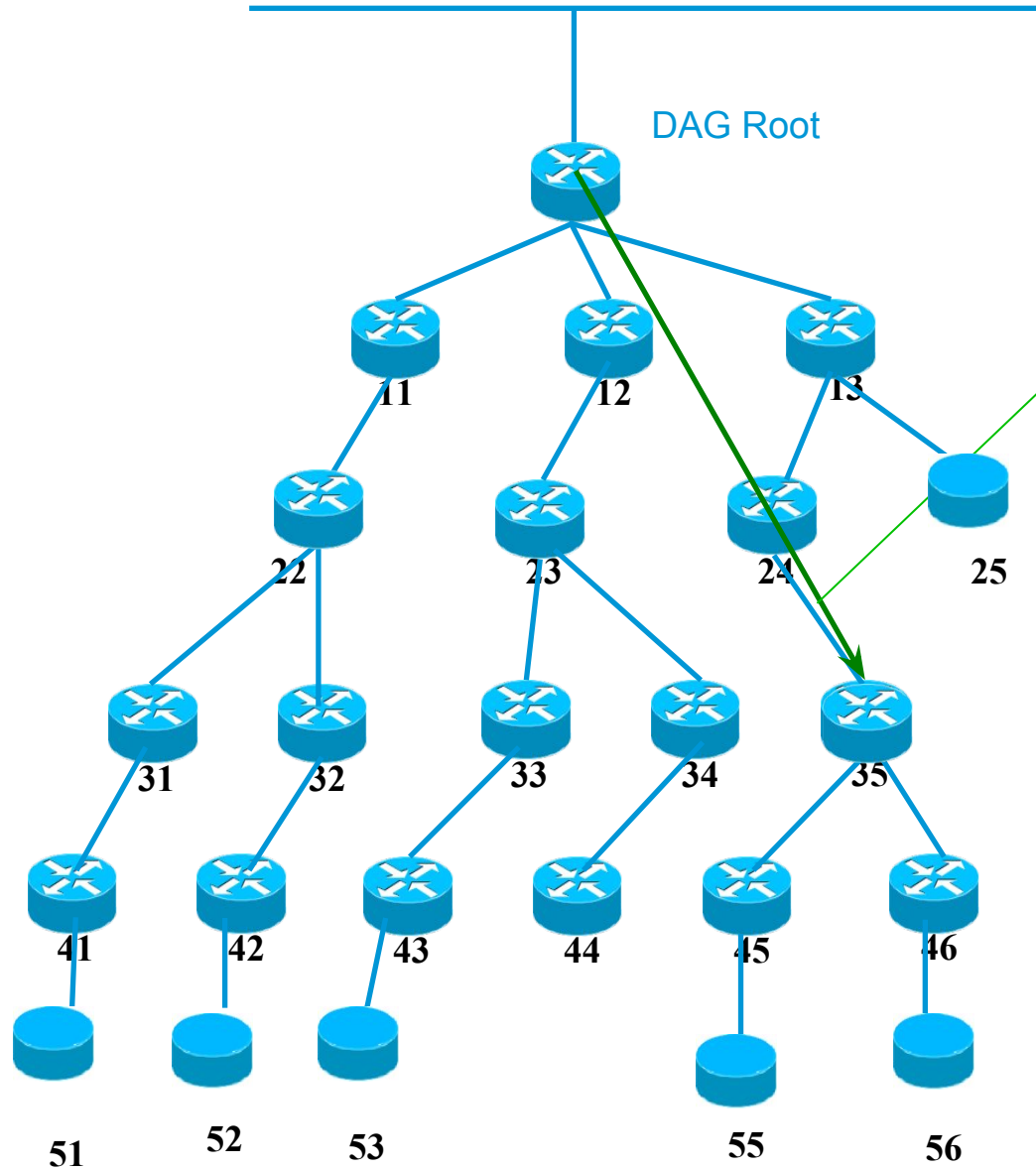

Adding New (projected) DAO with path segment unicast to target 56 via 13 (ingress), 24, and 35 (egress)



Application  
Server D

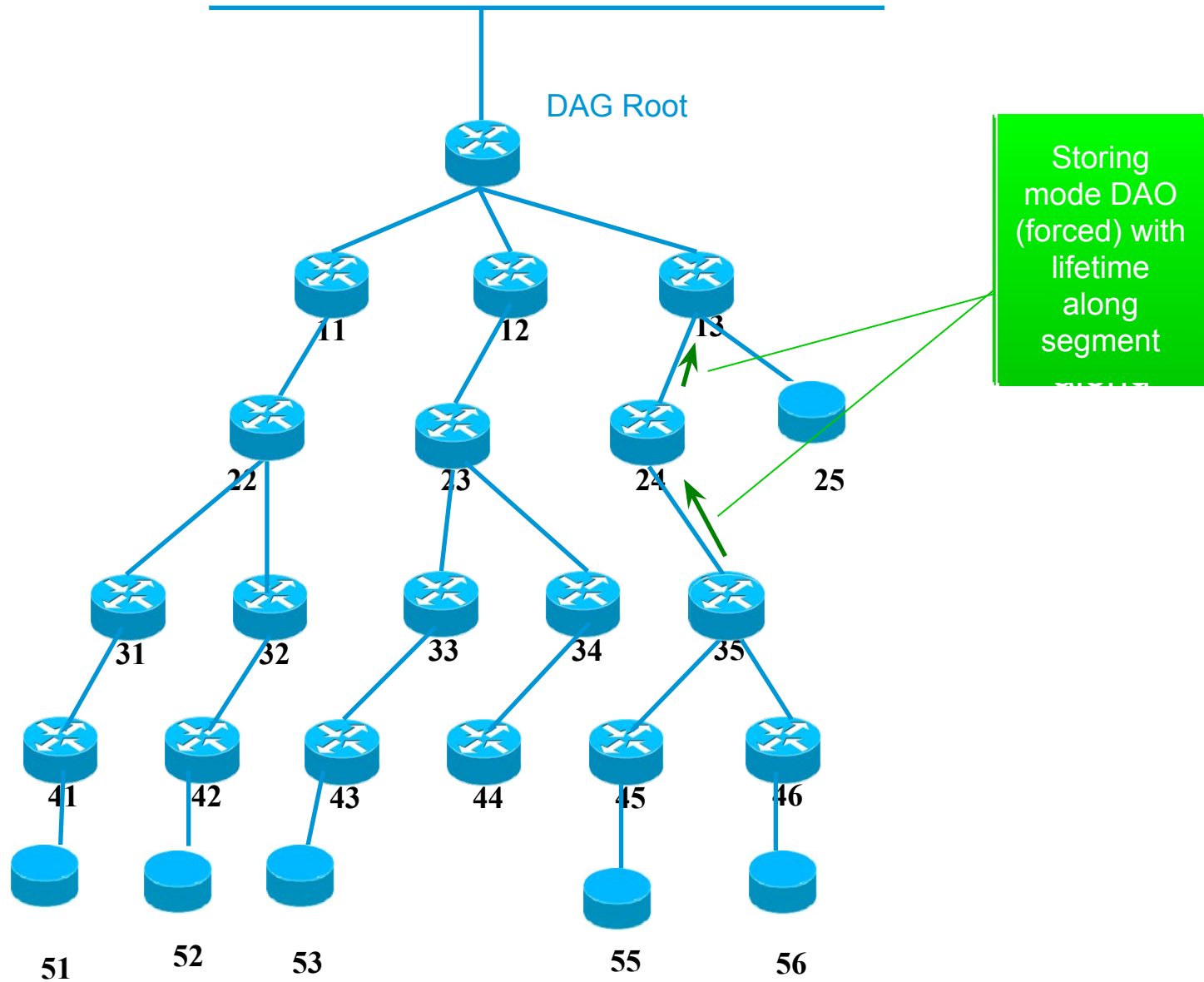



Application  
Server D

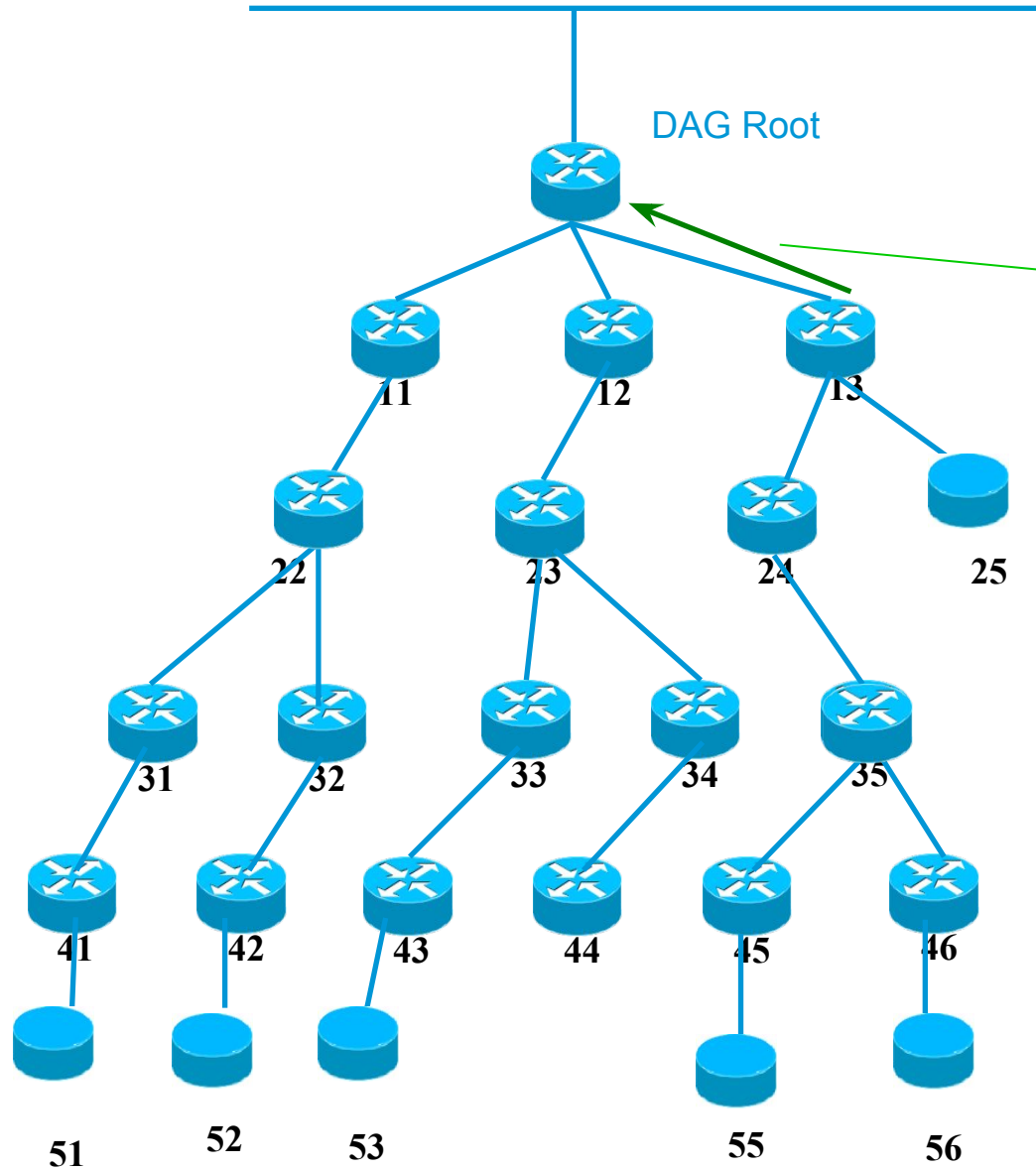

DAO-ACK (alt:  
non storing  
DAO) unicast,  
self 13 as  
parent, final  
destination 56  
as target



Application Server D

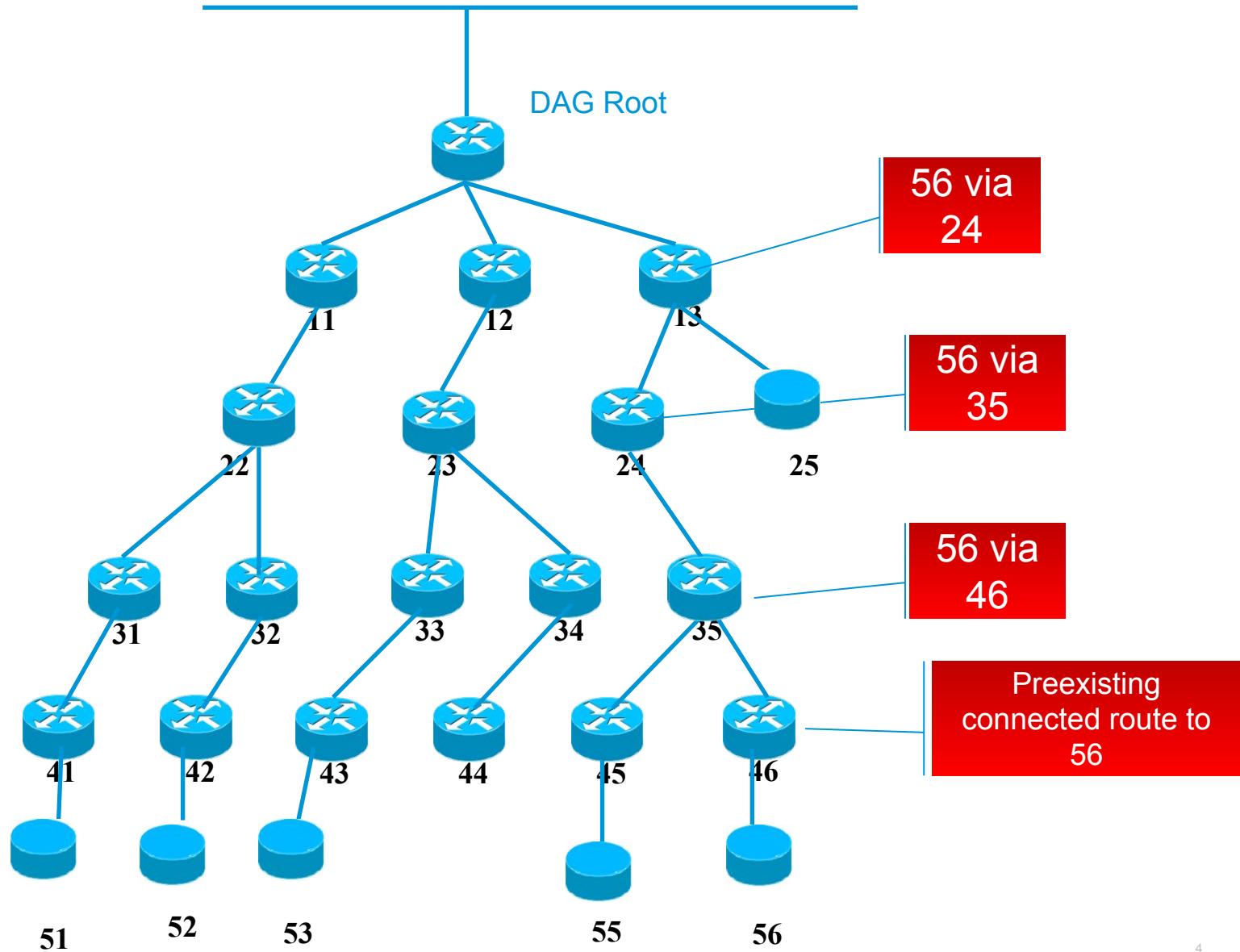



Application  
Server D

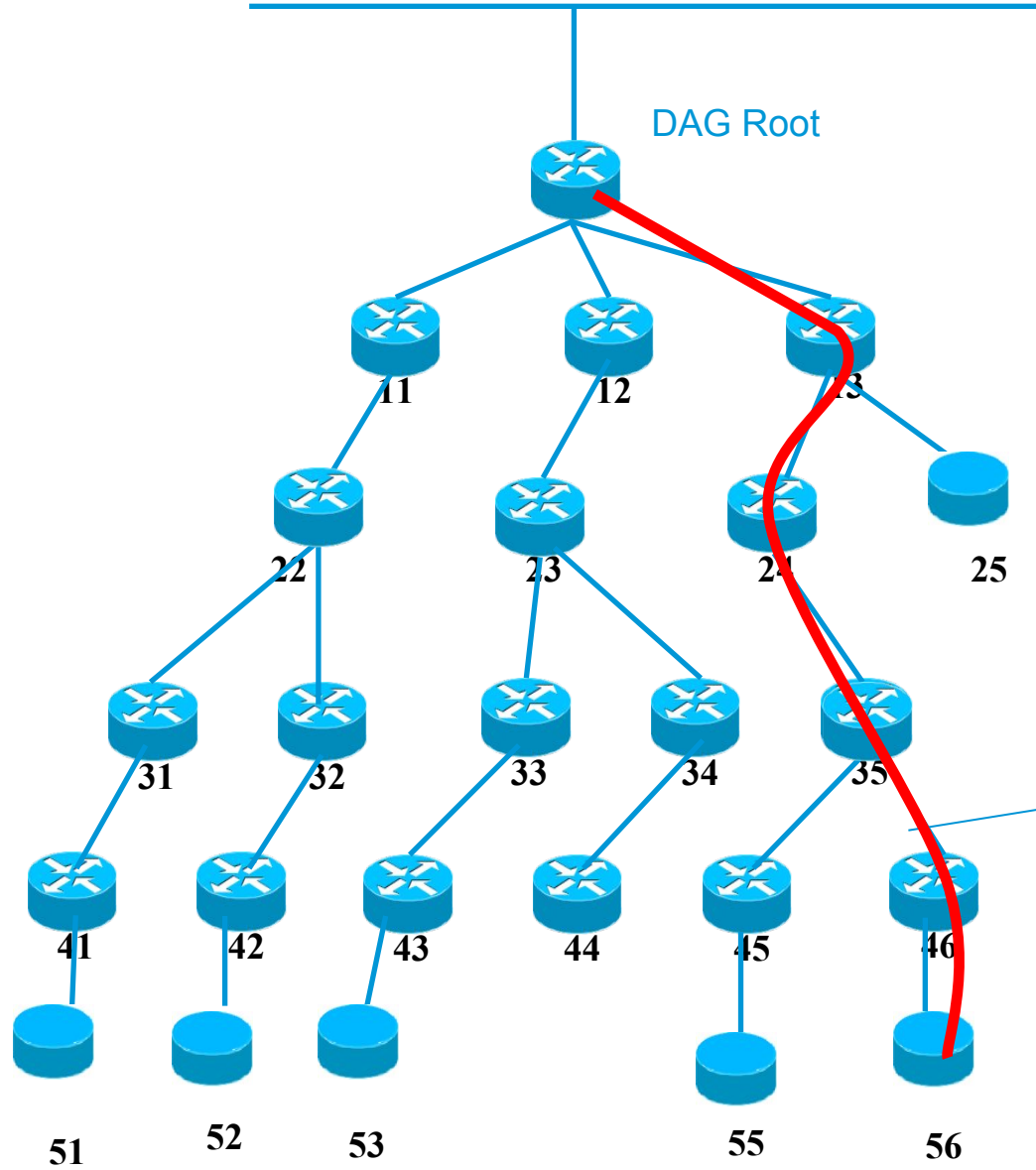

Non source  
routed  
DATA Path



Application  
Server D

# Alternate Programming By the root (Michael)

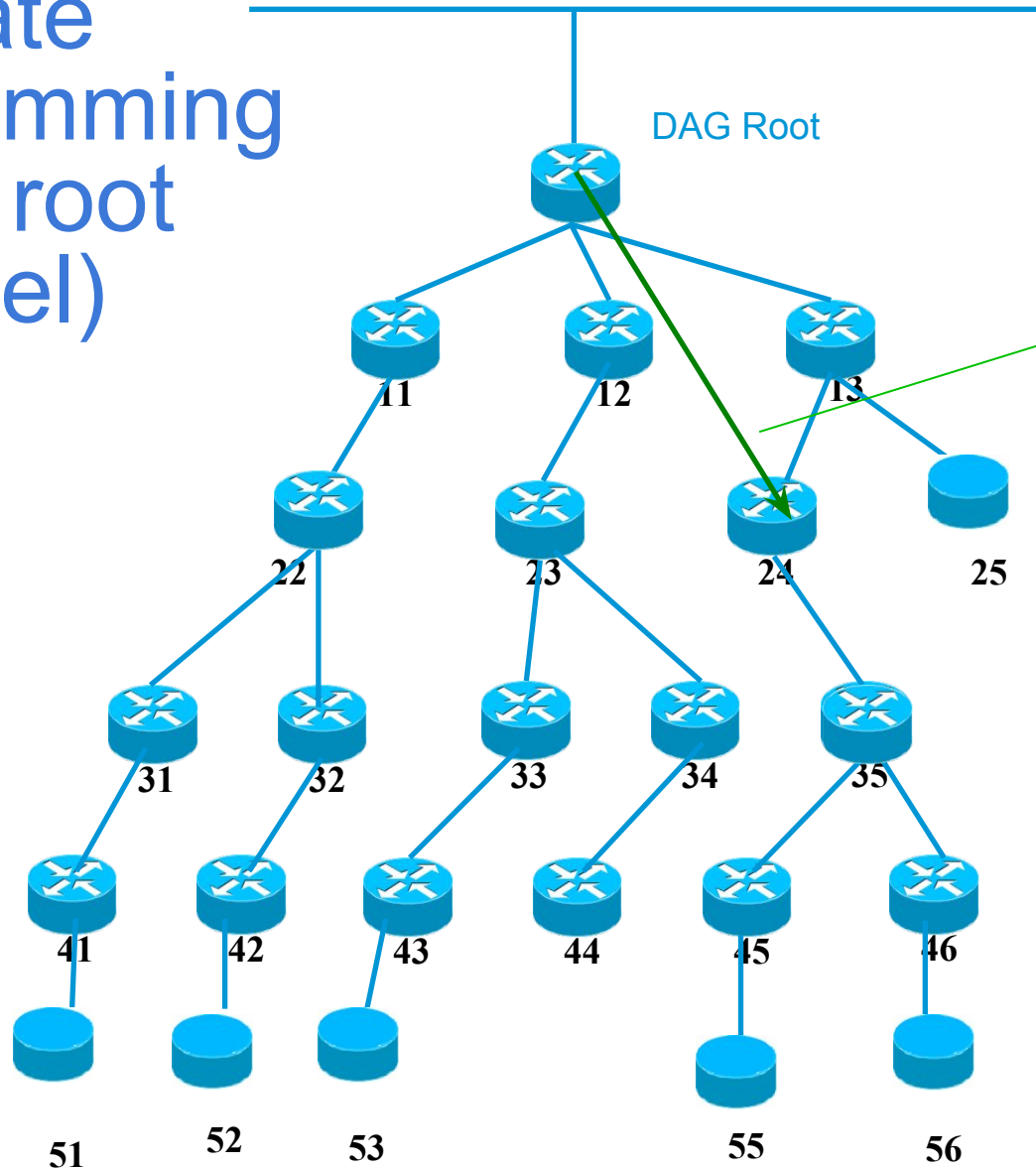

ALT: Adding  
New (projected)  
DAO with path  
segment unicast  
to target 35 via  
13 (ingress) and  
24 (egress)



Application Server D

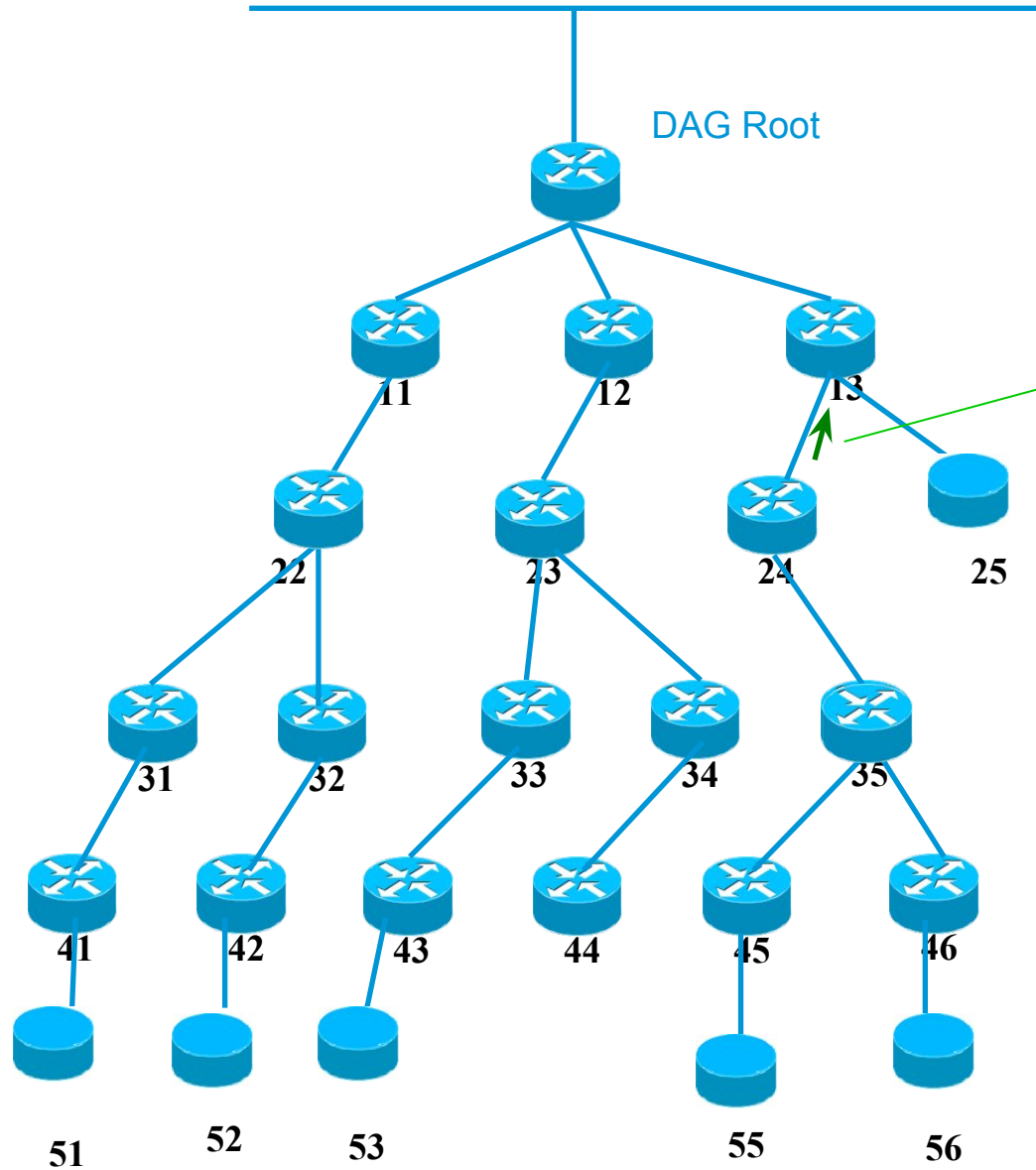

Storing mode DAO (forced) with lifetime along segment



Application  
Server D

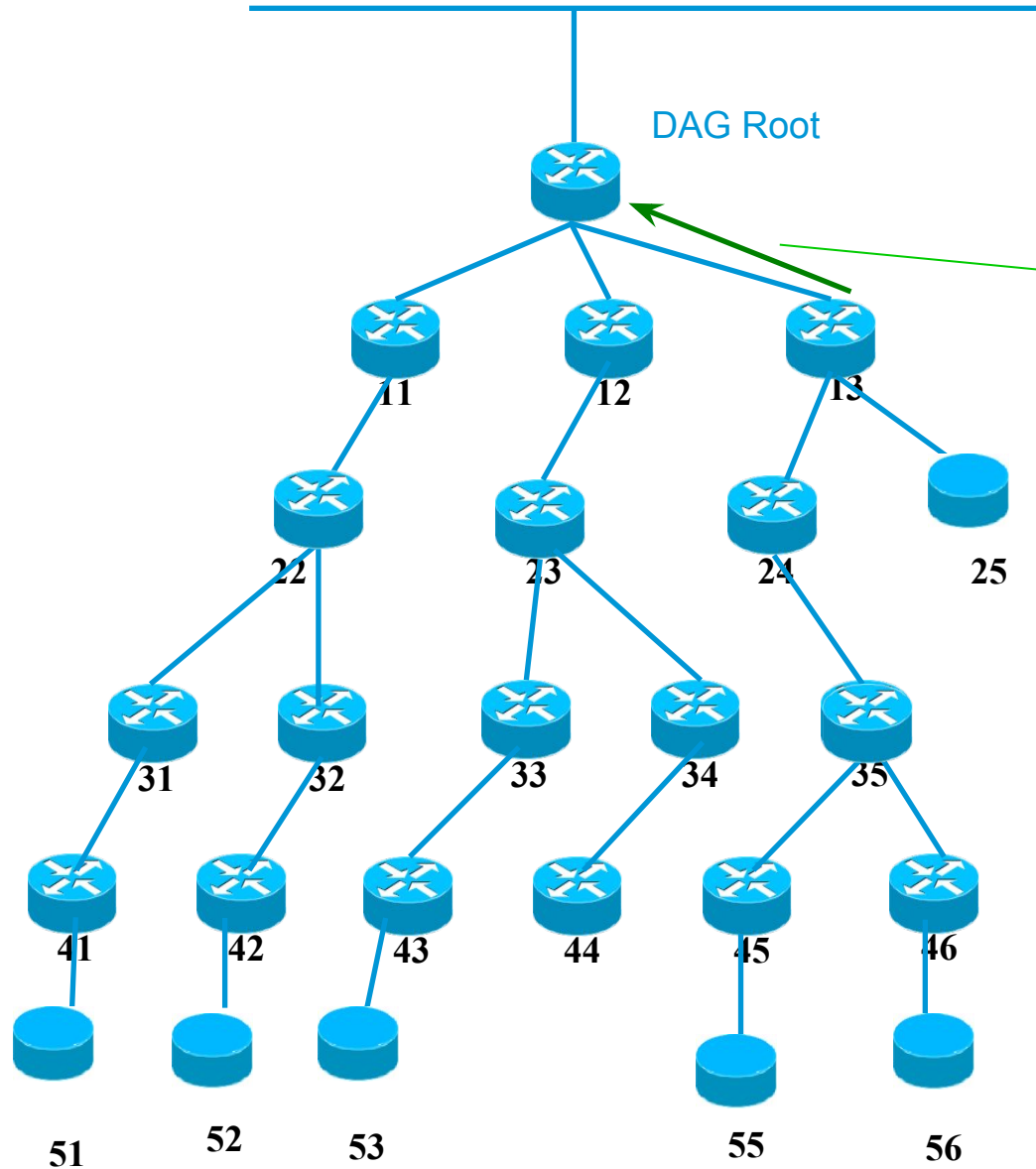

DAO-ACK (alt:  
non storing  
DAO) unicast,  
self 13 as  
parent, final  
destination 56  
as target





Application Server D

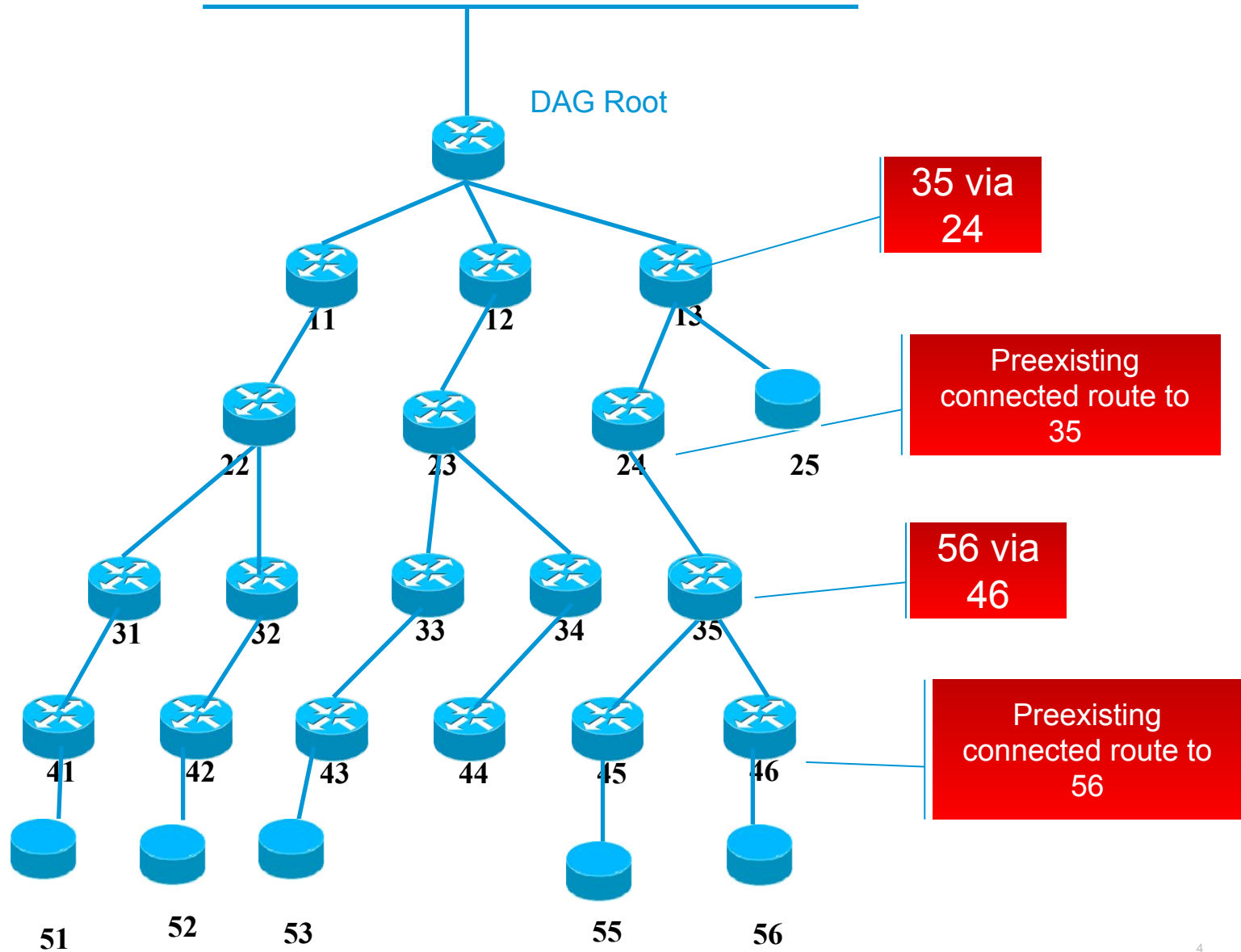



Application Server D

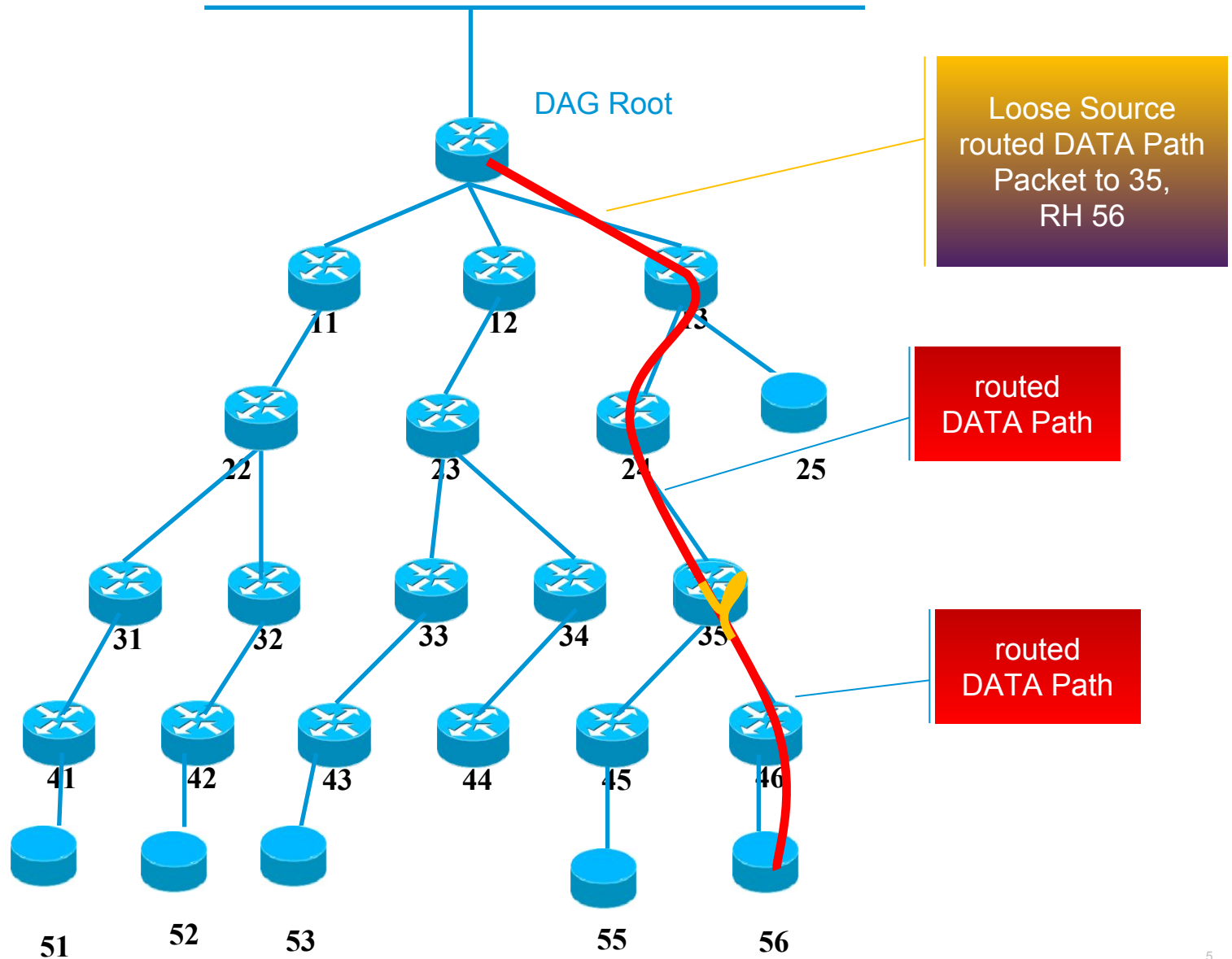

# Questions on the list

- Terminology:
  - Segment vs. projected route
  - New msg for “projected DAO”
- Need for a new MOP?
  - Suggestion to add a capability option in node’s original DAOs
- DAO direction, clarify flows
- Transversal routes
- DAO-ACK request bit setting
- -> or non storing DAO?

Arigatou!

A&Q